

Nikon

DIGITAL CAMERA

COOLPIX S60

User's Manual

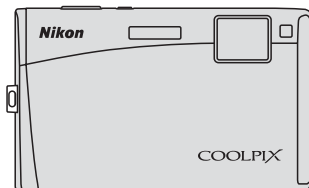

En

Trademark Information

- Microsoft, Windows and Windows Vista are either registered trademarks or trademarks of Microsoft Corporation in the United States and/or other countries.
- Macintosh, Mac OS, and QuickTime are trademarks of Apple Inc.
- Adobe and Acrobat are registered trademarks of Adobe Systems Inc.
- The SD logo is a trademark of the SD Card Association.
- PictBridge is a trademark.
- HD Pictmotion is powered by Nikon System Inc.
- HDMI, **HDMI** logo and High-Definition Multimedia Interface are trademarks or registered trademarks of HDMI Licensing LLC.
- All other trade names mentioned in this manual or the other documentation provided with your Nikon product are trademarks or registered trademarks of their respective holders.

Introduction

First Steps



Basic Photography and Playback: Auto Mode



Shooting Suited for the Scene



More on Playback



Movies



Voice Recordings

Connecting to Televisions, Computers and Printers

MENU Shooting, Playback and Setup Menus

Technical Notes

For Your Safety

To prevent damage to your Nikon product or injury to yourself or to others, read the following safety precautions in their entirety before using this equipment. Keep these safety instructions where all those who use the product will read them. The consequences that could result from failure to observe the precautions listed in this section are indicated by the following symbol:



This icon marks warnings, information that should be read before using this Nikon product, to prevent possible injury.

WARNINGS

Turn off in the event of malfunction

Should you notice smoke or an unusual smell coming from the camera or AC adapter, unplug the AC adapter and remove the battery immediately, taking care to avoid burns. Continued operation could result in injury. After removing or disconnecting the power source, take the equipment to a Nikon-authorized service representative for inspection.

Do not disassemble

Touching the internal parts of the camera or AC adapter could result in injury. Repairs should be performed only by qualified technicians. Should the camera or AC adapter break open as the result of a fall or other accident, take the product to a Nikon-authorized service representative for inspection, after unplugging the product and/or removing the battery.

Do not use the camera or AC adapter in the presence of flammable gas

Do not use electronic equipment in the presence of flammable gas, as this could result in explosion or fire.

Handle the camera strap with care

Never place the strap around the neck of an infant or child.

Keep out of reach of children

Particular care should be taken to prevent infants from putting the battery or other small parts into their mouths.

Observe caution when handling the battery

The battery may leak or explode if improperly handled. Observe the following precautions when handling the battery for use in this product:

- Before replacing the battery, turn the product off. If you are using the AC adapter, be sure it is unplugged.
- Only use a Rechargeable Li-ion Battery EN-EL10 (supplied). Charge the battery by inserting it in a Battery Charger MH-63 (supplied).
- When inserting the battery, do not attempt to insert it upside down or backwards.
- Do not short or disassemble the battery or attempt to remove or break the battery insulation or casing.
- Do not expose the battery to flame or to excessive heat.
- Do not immerse in or expose to water.
- Return the battery to the battery case for transportation. Do not transport or store with metal objects such as necklaces or hairpins.
- The battery is prone to leakage when fully discharged. To avoid damage to the product, be sure to remove the battery when no charge remains.
- Discontinue use immediately should you notice any change in the battery, such as discoloration or deformation.
- If liquid from the damaged battery comes in contact with clothing or skin, rinse immediately with plenty of water.

Observe the following precautions when handling the battery charger

- Keep dry. Failure to observe this precaution could result in fire or electric shock.
- Dust on or near the metal parts of the plug should be removed with a dry cloth. Continued use could result in fire.
- Do not handle the power cable or go near the battery charger during lightning storms. Failure to observe this precaution could result in electric shock.
- Do not damage, modify, forcibly tug or bend the power cable, place it under heavy objects, or expose it to heat or flames. Should the insulation be damaged and the wires become exposed, take it to a Nikon-authorized service representative for inspection. Failure to observe these precautions could result in fire or electric shock.
- Do not handle the plug or battery charger with wet hands. Failure to observe this precaution could result in electric shock.
- Do not use with travel converters or adapters designed to convert from one voltage to another or with DC-to-AC inverters. Failure to observe this precaution could damage the product or cause overheating or fire.

For Your Safety

Use appropriate cables

When connecting cables to the input and output jacks, use only the cables provided or sold by Nikon for the purpose, to maintain compliance with product regulations.

Handle moving parts with care

Be careful that your fingers or other objects are not pinched by the lens cover or other moving parts.

CD-ROMs

The CD-ROMs supplied with this device should not be played back on audio CD equipment. Playing CD-ROMs on an audio CD player could cause hearing loss or damage the equipment.

Observe caution when using the flash

Using the flash close to your subject's eyes could cause temporary visual impairment. Particular care should be observed if photographing infants, when the flash should be no less than one meter (3 ft. 4 in.) from the subject.

Do not operate the flash with the flash window touching a person or object

Failure to observe this precaution could result in burns or fire.

Avoid contact with liquid crystal

Should the monitor break, care should be taken to avoid injury caused by broken glass and to prevent liquid crystal from the monitor touching the skin or entering the eyes or mouth.

Notices

Notice for Customers in the U.S.A.

Federal Communications Commission (FCC) Radio Frequency Interference Statement

This equipment has been tested and found to comply with the limits for a Class B digital device, pursuant to Part 15 of the FCC rules. These limits are designed to provide reasonable protection against harmful interference in a residential installation. This equipment generates, uses, and can radiate radio frequency energy and, if not installed and used in accordance with the instructions, may cause harmful interference to radio communications. However, there is no guarantee that interference will not occur in a particular installation. If this equipment does cause harmful interference to radio or television reception, which can be determined by turning the equipment off and on, the user is encouraged to try to correct the interference by one or more of the following measures:

- Reorient or relocate the receiving antenna.
- Increase the separation between the equipment and receiver.
- Connect the equipment into an outlet on a circuit different from that to which the receiver is connected.
- Consult the dealer or an experienced radio/television technician for help.



Nikon
COOLPIX S60

CAUTIONS

Modifications

The FCC requires the user to be notified that any changes or modifications made to this device that are not expressly approved by Nikon Corporation may void the user's authority to operate the equipment.

Interface Cables

Use the interface cables sold or provided by Nikon for your equipment. Using other interface cables may exceed the limits of Class B Part 15 of the FCC rules.

Notice for customers in the State of California

WARNING

Handling the cord on this product will expose you to lead, a chemical known to the State of California to cause birth defects or other reproductive harm.

Wash hands after handling.

Nikon Inc.,
1300 Walt Whitman Road
Melville, New York 11747-3064
USA
Tel: 631-547-4200

Notice for customers in Canada

CAUTION

This Class B digital apparatus complies with Canadian ICES-003.

ATTENTION

Cet appareil numérique de la classe B est conforme à la norme NMB-003 du Canada.

Symbol for Separate Collection in European Countries

This symbol indicates that this product is to be collected separately.



The following apply only to users in European countries:

- This product is designated for separate collection at an appropriate collection point. Do not dispose of as household waste.
- For more information, contact the retailer or the local authorities in charge of waste management.

Table of Contents



For Your Safety	ii
WARNINGS	ii
Notices	v
<hr/>	
Introduction	1
About This Manual	1
Information and Precautions	2
Parts of the Camera	4
The Camera Body	4
Basic Operations of the Shutter-Release Button	4
Attaching the Camera Strap	5
Operating the Touch Panel	6
Tapping	6
Dragging	6
About the Stylus	6
Main Display of the Monitor/Touch Panel and Basic Operations	8
Shooting (Operation Controls)	8
Shooting (Other Indicators)	9
Playback (Operation Controls)	10
Playback (Information Display)	11
HOME Screen Controls	12
Menu Screen	13
<hr/>	
First Steps	14
Charging the Battery	14
Inserting the Battery	16
Removing the Battery	17
Turning On and Off the Camera	17
Setting Display Language, Date and Time	18
Inserting Memory Cards	20
Removing Memory Cards	20
<hr/>	
 Basic Photography and Playback: Auto Mode	22
Step 1 Turn the Camera On and Select  (Auto) Mode	22
Indicators Displayed in  (Auto) Mode	23
Step 2 Frame a Picture	24
Using the Zoom	25
Step 3 Focus and Shoot	26
Step 4 Playing Back and Deleting Pictures	28
Playing Back Pictures (Playback Mode)	28
Deleting Pictures	28
Using the Flash	30
Setting the Flash Mode	30

Table of Contents

Taking Pictures with the Self-timer	32
Automatic Shooting of a Smiling Face (Smile Timer)	33
Macro Mode	35
<hr/>	
SCENE Shooting Suited for the Scene	36
Shooting in Scene Mode	36
Setting the Scene Mode.....	36
Features	37
Shooting in the Scene Mode Selected by the Camera (Scene Auto Selector).....	43
Shooting in Portrait/Night Portrait Scene Mode.....	45
Taking Pictures in Food Mode	47
Using the Draw Option	49
Taking Pictures for a Panorama	50
<hr/>	
▶ More on Playback.....	52
Viewing Multiple Pictures: Thumbnail Playback	52
Taking a Closer Look: Playback Zoom	53
Editing Pictures	54
Paint Pictures.....	55
Creating a Cropped Copy: Trim.....	57
Stretching Pictures: Stretch.....	59
Adding a Sense of Perspective: Perspective control	60
Enhancing Brightness and Contrast: D-Lighting.....	61
Change Color Tones: Color Options	62
Resizing Pictures: Small Picture.....	63
Voice Memos: Recording and Playback	64
Recording Voice Memos	64
Playing Voice Memos	65
Deleting Voice Memos	65
Finding Pictures by Shooting Date (List by Date Mode)	66
Selecting a Date in List by Date Mode	66
Operations in List by Date Mode	67
Finding Pictures in Auto Sort Mode	69
Viewing Pictures in Auto Sort Mode.....	69
Operations in Auto Sort Mode	71
Sorting Favorite Pictures (Favorite Pictures Mode)	73
Preparing Favorites Folder.....	74
Sorting Pictures to Favorites Folders	75
Viewing Pictures in Favorites Folder	78
Operations in Favorite Pictures Mode	79



Enjoying Slide Show Using HD Pictmotion	82
Creating an HD Pictmotion Slide Show.....	82
Other Options for an HD Pictmotion Slide Show	85
Viewing an HD Pictmotion Slide Show.....	86
<hr/>	
 Movies	87
Recording Movies	87
The Movie Menu	88
Selecting Movie Options.....	88
Autofocus mode	90
Electronic VR.....	90
Time-Lapse Movies	91
Movie Playback	93
Deleting Movie Files.....	93
<hr/>	
 Voice Recordings	94
Making Voice Recordings.....	94
Playing Voice Recordings.....	96
Deleting Sound Files.....	97
Copying Voice Recordings.....	98
<hr/>	
Connecting to Televisions, Computers and Printers	99
Connecting to a TV.....	99
Connecting to a Computer.....	101
Before Connecting the Camera.....	101
Transferring Pictures from a Camera to a Computer	102
Connecting to a Printer.....	105
Connecting the Camera and Printer.....	106
Printing Pictures One at a Time	107
Printing Multiple Pictures	108
Creating a DPOF Print Order: Print Set	111
Creating a Print Order in Sort Mode	113
<hr/>	
MENU Shooting, Playback and Setup Menus	115
Shooting Options: The Shooting Menu	115
Displaying the Shooting Menu.....	115
Image Mode.....	116
White Balance	118
Exp.+/-	120
Continuous.....	121
ISO Sensitivity.....	123
AF Area Mode	124
Distortion Control	127
Functions that Cannot Be Applied Simultaneously	128

Table of Contents

Playback Options: The Playback Menu	129
Displaying the Playback Menu	129
Delete	130
Protect	131
Rotate Image	131
Copy	132
Basic Camera Setup: The Setup Menu	133
Displaying the Setup Menu	134
Choose HOME Display	134
Welcome Screen	135
Date	136
Monitor Settings	139
Date Imprint	140
Vibration Reduction	142
AF Assist	142
Digital Zoom	143
Sound Settings	143
Record Orientation	144
Auto Off	144
Format Memory/Format Card	145
Language	146
TV Settings	146
Blink Warning	146
Reset All	147
Firmware Version	149
<hr/>	
Technical Notes	150
Optional Accessories	150
Approved Memory Cards	150
Image/Sound File and Folder Names	151
Caring for the Camera	152
Cleaning	154
Storage	154
Error Messages	155
Troubleshooting	159
Specifications	165
Supported Standards	168
Index	169

About This Manual

Thank you for your purchase of a Nikon COOLPIX S60 digital camera. This manual was written to help you enjoy taking pictures with your Nikon digital camera. Read this manual thoroughly before use, and keep it where all those who use the product will read it.

Symbols and Conventions

To make it easier to find the information you need, the following symbols and conventions are used:



This icon marks cautions, information that should be read before use, to prevent damage to the camera.



This icon marks tips, additional information that may be helpful when using the camera.



This icon marks notes, information that should be read before using the camera.



This icon indicates that more information is available elsewhere in this manual or in the *Quick Start Guide*.

Notations

- A Secure Digital (SD) memory card is referred to as a “memory card.”
- The setting at the time of purchase is referred to as the “default setting.”
- The names of menu items displayed in the camera monitor, and the names of buttons or messages displayed in the computer monitor appear in bold.

Screen Samples

In this manual, images are sometimes omitted from monitor display samples so that monitor indicators can be more clearly shown.

Illustrations and Screen Display

Illustrations and text displays shown in this manual may differ from actual display.

Memory Cards

Pictures taken with this camera can be stored in the camera’s internal memory or on removable memory cards. If a memory card is inserted, all new pictures will be stored on the memory card and delete, playback and format operations will apply only to the pictures on the memory card. The memory card must be removed before the internal memory can be formatted or used to store pictures to, or delete, or view pictures.

Information and Precautions

Life-Long Learning

As part of Nikon's "Life-Long Learning" commitment to ongoing product support and education, continually updated information is available online at the following sites:

- For users in the U.S.A.: <http://www.nikonusa.com/>
- For users in Europe and Africa: <http://www.europe-nikon.com/support/>
- For users in Asia, Oceania, and the Middle East: <http://www.nikon-asia.com/>

Visit these sites to keep up-to-date with the latest product information, tips, answers to frequently asked questions (FAQs), and general advice on digital imaging and photography. Additional information may be available from the Nikon representative in your area. See the URL below for contact information:

<http://imaging.nikon.com/>

Use Only Nikon Brand Electronic Accessories

Nikon COOLPIX cameras are designed to the highest standards and include complex electronic circuitry. Only Nikon brand electronic accessories (including battery chargers, batteries and AC adapters) certified by Nikon specifically for use with this Nikon digital camera are engineered and proven to operate within the operational and safety requirements of this electronic circuitry.

THE USE OF NON-NIKON ELECTRONIC ACCESSORIES COULD DAMAGE THE CAMERA AND MAY VOID YOUR NIKON WARRANTY.

The use of third-party rechargeable Li-ion batteries not bearing the Nikon holographic seal could interfere with normal operation of the camera or result in the batteries overheating, igniting, rupturing, or leaking.

For more information about Nikon brand accessories, contact a local authorized Nikon dealer.

Holographic seal: Identifies this device as an authentic Nikon product.



Rechargeable Li-ion Battery EN-EL10

Before Taking Important Pictures

Before taking pictures on important occasions (such as at weddings or before taking the camera on a trip), take a test shot to ensure that the camera is functioning normally. Nikon will not be held liable for damages or lost profits that may result from product malfunction.

About the Manuals

- No part of the manuals included with this product may be reproduced, transmitted, transcribed, stored in a retrieval system, or translated into any language in any form, by any means, without Nikon's prior written permission.
- Nikon reserves the right to change the specifications of the hardware and software described in these manuals at any time and without prior notice.
- Nikon will not be held liable for any damages resulting from the use of this product.
- While every effort was made to ensure that the information in these manuals is accurate and complete, we would appreciate it were you to bring any errors or omissions to the attention of the Nikon representative in your area (address provided separately).

Notice Concerning Prohibition of Copying or Reproduction

Note that simply being in possession of material that was digitally copied or reproduced by means of a scanner, digital camera or other device may be punishable by law.

- **Items prohibited by law from being copied or reproduced**

Do not copy or reproduce paper money, coins, securities, government bonds or local government bonds, even if such copies or reproductions are stamped "Sample." The copying or reproduction of paper money, coins, or securities which are circulated in a foreign country is prohibited. Unless the prior permission of the government was obtained, the copying or reproduction of unused postage stamps or post cards issued by the government is prohibited. The copying or reproduction of stamps issued by the government and of certified documents stipulated by law is prohibited.

- **Cautions on certain copies and reproductions**

The government has issued cautions on copies or reproductions of securities issued by private companies (shares, bills, checks, gift certificates, etc.), commuter passes or coupon tickets, except when a minimum of necessary copies are to be provided for business use by a company. Also, do not copy or reproduce passports issued by the government, licenses issued by public agencies and private groups, ID cards and tickets, such as passes and meal coupons.

- **Comply with copyright notices**

The copying or reproduction of copyrighted creative works such as books, music, paintings, woodcut prints, maps, drawings, movies and photographs is governed by national and international copyright laws. Do not use this product for the purpose of making illegal copies or to infringe copyright laws.

Disposing of Data Storage Devices

Please note that deleting images or formatting data storage devices such as memory cards or built-in camera memory does not completely erase the original image data. Deleted files can sometimes be recovered from discarded storage devices using commercially available software, potentially resulting in the malicious use of personal image data. Ensuring the privacy of such data is the user's responsibility.

Before discarding a data storage device or transferring ownership to another person, erase all data using commercial deletion software, or format the device and then completely refill it with images containing no private information (for example, pictures of empty sky). Be sure to also replace any pictures selected for the welcome screen (📷 135). Care should be taken to avoid injury or damage to property when physically destroying data storage devices.

Parts of the Camera

The Camera Body

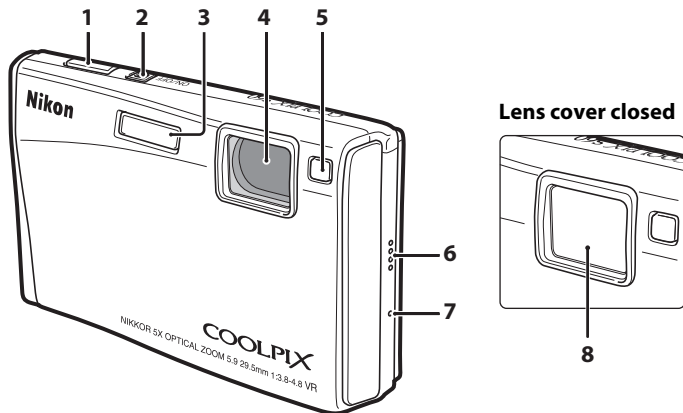

1	Shutter-release button.....	26	5	Self-timer lamp.....	32, 33
2	Power switch/Power-on lamp	22, 144	6	AF-assist illuminator.....	27, 142
3	Built-in flash.....	30	7	Speaker.....	65, 86, 93, 96
4	Lens.....	154, 165	8	Microphone.....	64, 87, 94
				Lens cover.....	152

Basic Operations of the Shutter-Release Button

The camera features a two-stage shutter-release button. To set focus and exposure, press the shutter-release button halfway, stopping when you feel resistance. Focus and exposure lock while the shutter-release button is held in this position. To release the shutter and take a picture, press the shutter-release button the rest of the way down. Do not use force when pressing the shutter-release button, as this may result in camera shake and blurred pictures.



Press the shutter-release button halfway to set focus and exposure.

Press the shutter-release button the rest of the way down to take picture.

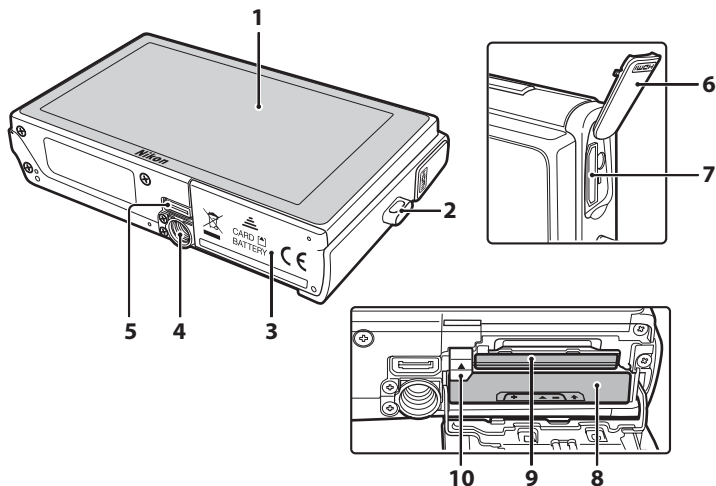

1	Monitor/touch panel.....	8	6	HDMI connector cover.....	99
2	Eyelet for camera strap.....	5	7	HDMI Mini Connector.....	99
3	Battery-chamber/ memory card slot cover.....	16, 20	8	Battery-chamber.....	16
4	Tripod socket		9	Memory card slot.....	20
5	Multi connector.....	99, 102, 106	10	Battery latch.....	16, 17

Attaching the Camera Strap

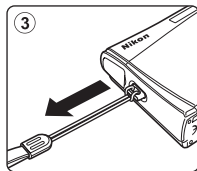
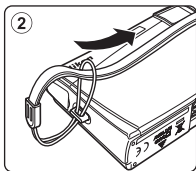
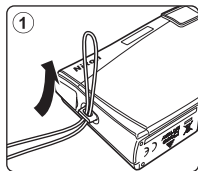

Operating the Touch Panel

The COOLPIX S60's monitor is a touch panel display. Operate the touch panel with your finger or the supplied stylus.

Introduction

Tapping

Tap the touch panel.

Use this operation to select a control or picture.

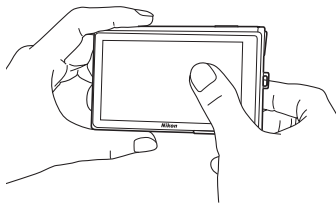

Dragging

Drag your finger across the touch panel.

Use this operation to view the previous or subsequent picture during playback.

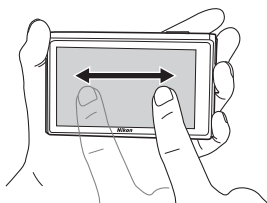

About the Stylus

Use the stylus when you find that operation using your finger is difficult, such as when using the **Paint** option (🎨 55), or the **Draw** option (🖌️ 49).



Attaching the Stylus

Attach the stylus to the strap as shown.

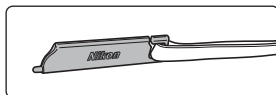

✓ Notes on the Touch Panel and the Stylus

- Do not press on the touch panel with pointed objects other than the supplied stylus.
- Do not scratch or press the touch panel too hard.
- Do not place the stylus where small children can reach.
- Do not carry the camera by the stylus. The strap may slip off the stylus and the camera may fall.

Main Display of the Monitor/Touch Panel and Basic Operations

Shooting (Operation Controls)

Tap the following controls to change settings.

- The controls available and indicators displayed vary with shooting mode and the current camera settings.

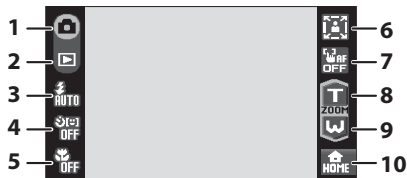

1		Shooting mode..... 22, 36, 87
2		Switch to playback mode..... 28
3		Flash mode 30
4		Self-timer 32 Smile timer 33
5		Macro mode..... 35

6		Portrait one-touch zoom (in Portrait or Night portrait scene mode).... 46
7		White balance (in Food scene mode)..... 47
8		Touch AF/AE cancellation 24
9		Tele zoom 25
9		Wide zoom 25
10		Switching to the HOME screen 12

Shooting (Other Indicators)

The following monitor display shows the current settings applied from the shooting menu (📷 115) and focus area.

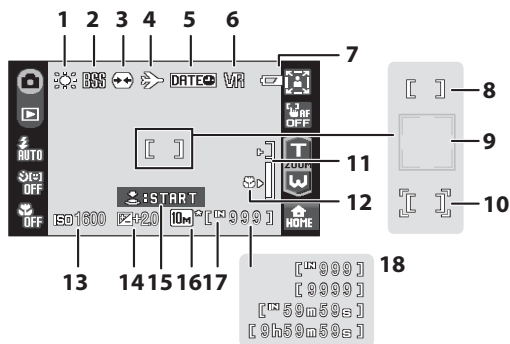

1	PRE 📷 📷 📷 📷 📷 📷	White balance mode.....118
2	📷 📷 📷 BSS	Continuous shooting mode, BSS.....121
3	↔️	Distortion control indicator127
4	🕒 ➡️	"Date not set" indicator155 Time zone indicator136
5	DATE DATE@ 1123 1 1123 2 1123 3	Date imprint140
6	VR 📷	Vibration reduction icon (still pictures).....142 Electronic VR icon (movies).....90
7	🔋	Battery level indicator22
8		Focus area26, 124
9		Focus area (Face Priority)26, 124
10		Focus area (touch AF/AE)24

11	📷	Zoom indicator25, 35
12	📷	Macro mode35
13	ISO	ISO sensitivity31, 123
14	+2.0	Exposure compensation value120
15	📷 :START	Smile timer guide (when the smile timer is activated).....33
16	10M 10M 5M 3M TV PC 16:9 16:9	Image mode116
17	TV 320 320 320	Movie options.....88
17	IN	Internal memory indicator23
18		Number of exposures remaining (still pictures).....22 Movie length87

Information Displayed in the Monitor

- The indicators displayed vary with current camera settings and shooting mode.
- Information on settings applied from the shooting menu is displayed for only a few seconds (📷 139).

Playback (Operation Controls)

Tap the following controls to switch between monitor displays, or delete or edit pictures.

- The controls available and indicators displayed vary with the picture played back and the current camera settings.

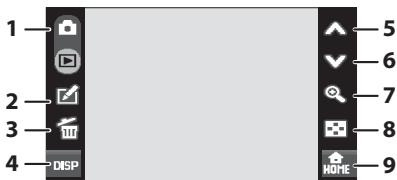

1		Switch to shooting mode 22, 36, 87
2		Editing (still pictures) 54 Volume (HD Pictmotion slide show, movie, or sound file playback) 65, 86, 93, 97
3		Delete 28
4		Information display On/Off 29

5		Display previous picture 28
6		Display subsequent picture 28
7		Playback zoom 53
8		Thumbnail display 52
9		Switch to the HOME screen 12

Photo Information and Controls Display

When the camera enters playback mode from shooting mode, the information display turns off. Tap to toggle the information display on and off. When the information display is on, photo information and all available controls are displayed. Playback mode monitor displays, with the information display on, are used for explanation purposes here.



Playback (Information Display)

The following monitor display shows information for the picture currently displayed.

- Tap **DISP** to toggle photo information on and off.

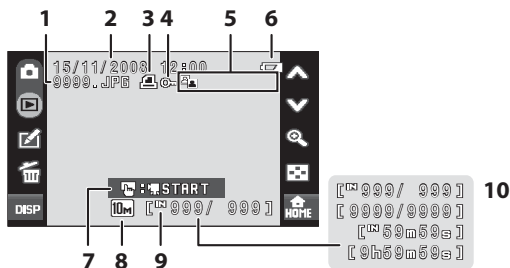

1	File number and type.....	151	6	Battery level indicator.....	22
2	Date/time of recording.....	18	7	Movie playback guide.....	93
3	Print-order icon.....	111		Image mode.....	116
4	Protect icon.....	131	8	Movie options.....	88
5	Editing functions		9	Internal memory indicator.....	28
	Paint icon.....	55	10	Current frame number/ total number of frames.....	28
	Stretch icon.....	59		Movie length.....	93
	Perspective control icon.....	60			
	D-Lighting icon.....	61			
	Color options icon.....	62			
	Small picture icon.....	63			
	Voice memo icon.....	65			

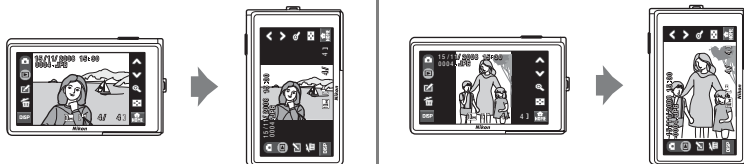

Picture Display

When the camera is rotated, the picture displayed is also rotated as indicated below.



Pictures may not be appropriately rotated when the lens is pointing up or down.

HOME Screen Controls



Tap , displayed in the lower right corner of the monitor, in shooting or playback mode ( 8,  10) to switch to the HOME screen.

The shooting, playback, and setup menus can be displayed from the HOME screen.



- | | | | |
|----------|---|----------|---|
| 1 | Switch to  (auto) mode22 | 5 | Display the menu available for the current mode.....88, 115, 129 |
| 2 | Switch to scene mode36 | 6 | Display the setup menu to adjust basic camera setup options.....133 |
| 3 | Switch to movie mode87 | 7 | Return to shooting or playback mode |
| 4 | Switch to playback mode28 | | |

HOME Screen Display Design

The display design for the HOME screen can be changed from the **Choose HOME display** option ( 134) in the setup menu ( 133).

Menu Screen

Tap the menu control or setup control in the HOME screen to display the menu screen.

When the menu item is tapped, the setting screen for the selected menu item is displayed.

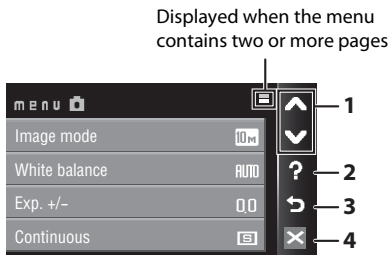

1 : Display the previous or subsequent page.

2 : Display the help selection screen. Tap a menu item or option to view a description of that feature or setting.

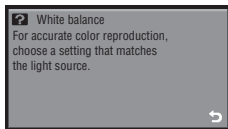
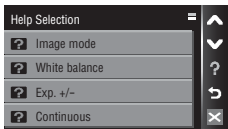

3 : Return display to the previous screen.

4 : Exit the menu and return to shooting or playback mode.

Charging the Battery

The camera uses a Rechargeable Li-ion Battery EN-EL10 (supplied).

Charge the battery with the Battery Charger MH-63 (supplied) before first use or when the battery is running low.

1 Connect the power cable.

Connect the power cable to the battery charger ① and insert the wall plug into a power outlet ②. The CHARGE lamp will light to show that the charger is on ③.

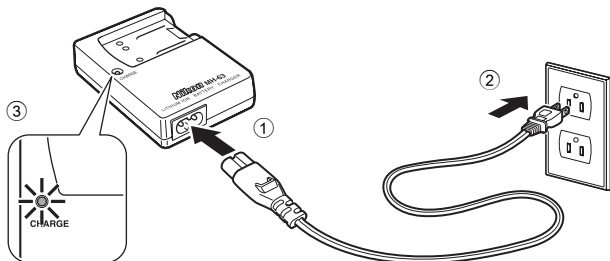

2 Charge the battery.

Insert the battery ① to set it to the battery charger ②.

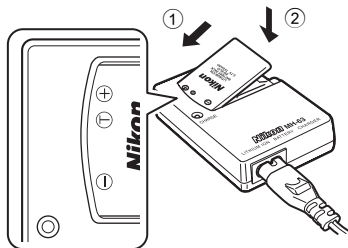

CHARGE lamp starts blinking when battery is inserted ③. Charging is complete when lamp stops blinking ④.

About 100 minutes are required to charge a fully depleted battery.

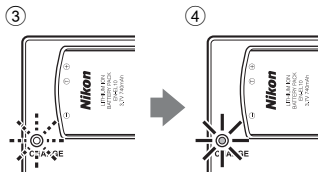

The following chart explains CHARGE lamp status.

CHARGE lamp	Description
Blinks	Battery charging.
On	Battery fully charged.
Flickers	<p>The battery is not inserted correctly. Remove the battery and reinsert it into the battery charger so that the battery is lying flat.</p> <ul style="list-style-type: none"> • Charge the battery indoors with an ambient temperature of 5 °C to 35 °C (41 °F to 95 °F) before use. • The battery is faulty. Unplug the charger immediately and stop charging the battery. Bring the battery and charger to a Nikon-authorized service representative for inspection.

3 Unplug the charger when charging is complete.

Remove the battery and unplug the charger.

Note on the Battery Charger

- The supplied battery charger is for use only with a Rechargeable Li-ion Battery EN-EL10. Do not use with incompatible batteries.
- Be sure to read and follow the warnings for the battery charger on page iii before using the battery charger.
- If the battery will not be used for an extended period, recharge it at least once every six months and run it flat before returning it to storage.

Note on the Battery

Be sure to read and follow the warnings for the battery on page iii and the section, “The Battery” (📖 153), before using the battery.

Note on AC power supply

To power the camera continuously for extended periods, use an AC Adapter EH-63 (available separately from Nikon) (📖 150). Do not, under any circumstances, use another make or model of AC adapter. Failure to observe this precaution could result in overheating or in damage to the camera. The AC adapter and the supplied audio/video cable or USB cable cannot be used at the same time.

Inserting the Battery

Insert a Rechargeable Li-ion Battery EN-EL10 (supplied) that has been fully charged, using the Battery Charger MH-63 (supplied), into your camera.

- 1 Open the battery-chamber/memory card slot cover.

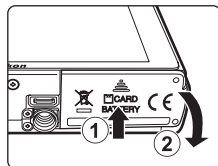

- 2 Insert the battery.

Confirm that the positive (+) and negative (-) terminals are oriented correctly as described on the label at the entrance of the battery chamber, and insert the battery.

Use the battery to push the orange battery latch up ① as the battery is inserted ②. The battery latch will spring back into place when the battery is fully inserted.

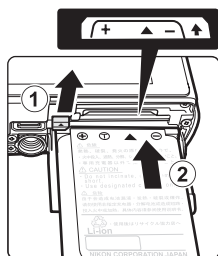

✓ Inserting the Battery

Inserting the battery upside down or backwards could damage the camera. Be sure to check the battery is in the correct orientation.

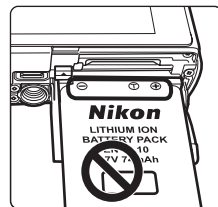

- 3 Close the battery-chamber/memory card slot cover.

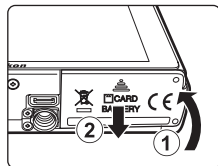

Removing the Battery

Turn the camera off and make sure that the power-on lamp and the monitor have gone out before opening the battery-chamber/memory card slot cover.

To eject the battery, open the battery-chamber/memory card slot cover and slide the battery latch in the direction shown ①. The battery can then be removed by hand ②.

- Note that the battery may become hot during use; observe due caution when removing the battery.

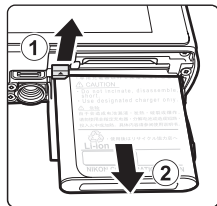

Turning On and Off the Camera

To turn on the camera, press the power switch. The power-on lamp (green) will light for a moment and the monitor will turn on.

To turn off the camera, press the power switch again. When the camera turns off, both the power-on lamp and monitor will turn off.

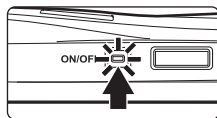

Auto Power Off in Shooting Mode (Standby Mode)

If no operations are performed for about a minute (default setting), the monitor will turn off automatically and the camera will enter standby mode. If no operations are performed for another three minutes, the camera will turn off automatically (the auto off function).

Pressing the power switch, or the shutter-release button, while the monitor is off in standby mode will reactivate the monitor.

The time allowed to elapse from before the camera enters standby mode can be changed from the **Auto off** option (📷 144) in the setup menu (📷 133).

Setting Display Language, Date and Time



A language-selection dialog is displayed the first time the camera is turned on.

1 Press the power switch to turn on the camera.

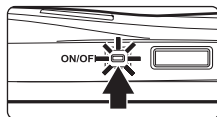
The power-on lamp (green) will light for a moment and the monitor will turn on.



2 Tap the desired language.

If the desired language is not displayed, tap  or  to view other language options.

For more information about operating the touch panel, see "Operating the Touch Panel" ( 6).



3 Tap Yes.

If **No** is tapped, the date and time will not be set.

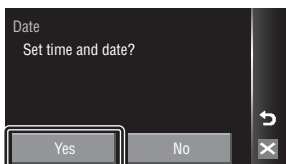

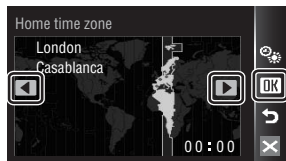

4 Tap or to select your home time zone (138) and tap **OK**.



Daylight Saving Time

If daylight saving time is in effect, tap  in the time zone selection screen displayed in step 4 to turn on the daylight saving time option.

 glows yellow when the daylight saving option is enabled.

To turn off the daylight saving option, tap  again.



5 Edit the date and time.

Tap ▲ or ▼ to edit the highlighted item.

**6** Tap ◀ or ▶ to choose the order in which the day, month and year are displayed.**7** Tap OK.

The settings are applied and monitor display exits to shooting mode.



Changing the Date and Time

- Select **Date** from the **Date** item (🔍 136) in the setup menu (🔍 133) to change the current date and time and follow the procedure described in step 5 above.
- Select **Time zone** from the **Date** item (🔍 136) in the setup menu (🔍 133) to change the time zone and daylight saving time settings.

Inserting Memory Cards

Image, sound, and movie files are stored in the camera's internal memory (approximately 20 MB) or on removable memory cards (available separately) (150).

If a memory card is inserted in the camera, data are automatically stored on the memory card and data recorded to the memory card can be played back, deleted or transferred. Remove the memory card to store data in the internal memory, or play back, delete or transfer data from the internal memory.

- 1 Confirm the power-on lamp and the monitor are off and open the battery-chamber/memory card slot cover.

Be sure to turn off the camera before opening the battery-chamber/memory card slot cover.

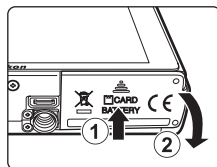

- 2 Insert the memory card.

Slide the memory card in correctly until it clicks into place.

Close the battery-chamber/memory card slot cover.

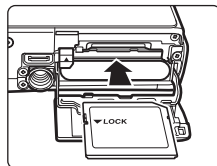

Inserting Memory Cards

Inserting the memory card upside down or backwards could damage the camera or the memory card. Make sure that the memory card is correctly oriented.

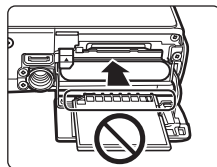

Removing Memory Cards

Before removing memory cards, turn the camera off and confirm that the power-on lamp and the monitor are off. Open the battery-chamber/memory card slot cover and press the card in ① to partially eject the card ②. The card can then be removed by hand.

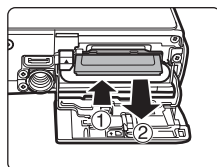

✔ Formatting Memory Cards

If the message at right is displayed, the memory card must be formatted before use (☞ 145). Note that **formatting permanently deletes all pictures and other data on the memory card**. Be sure to make copies of any pictures you wish to keep before formatting the memory card.

Tap **Yes**. The confirmation dialog will be displayed. To start formatting, tap **Yes**.

- Do not turn the camera off or open the battery-chamber/memory card slot cover until formatting is complete.
- The first time you insert the memory cards used in other devices into the COOLPIX S60, be sure to format them using this camera (☞ 145).

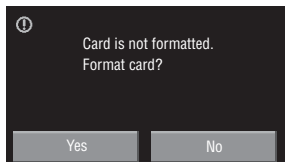

✔ The Write Protect Switch

Memory cards are equipped with a write protect switch. When this switch is in the "lock" position, data cannot be written to, or deleted from, the memory card. If the switch is in the "lock" position, unlock it by sliding the switch to the "write" position to record or delete pictures, or to format the memory card.

Write protect switch

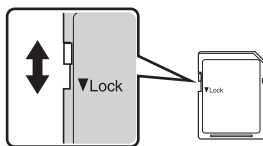

✔ Memory Cards

- Use only Secure Digital memory cards.
- Do not perform the following during formatting, while data is being written to or deleted from the memory card, or during data transfer to a computer. Failure to observe this precaution could result in the loss of data or in damage to the camera or memory card:
 - Take out the battery or memory card
 - Turn off the camera
 - Disconnect the AC adapter
- Do not use a computer to format the memory card.
- Do not disassemble or modify.
- Do not drop, bend, or expose to water or strong physical shocks.
- Do not touch the metal terminals with your fingers or metal objects.
- Do not affix labels or stickers to the memory card.
- Do not leave in direct sunlight, closed vehicles or areas exposed to high temperatures.
- Do not expose to humidity, dust, or to corrosive gases.

Step 1 Turn the Camera On and Select (Auto) Mode

This section describes how to take pictures in  (auto) mode, an automatic, “point-and-shoot” mode recommended for first-time users of digital cameras.

1 Press the power switch to turn on the camera.

The power-on lamp (green) will light for a moment and the monitor will turn on.

 (auto) mode is initially activated at the time of purchase. Proceed to step 4.

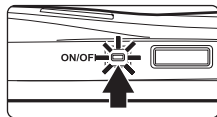

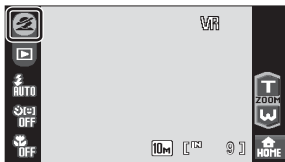

2 Tap the shooting mode control.



3 Tap .

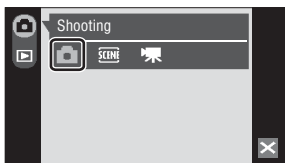

The camera enters  (auto) mode.

 (auto) mode can also be applied by tapping  in the HOME screen, displayed by tapping .



4 Check the battery level and number of exposures remaining.

Battery Level

Monitor	Description
NO INDICATOR	Battery fully charged.
	Battery low; prepare to charge or replace the battery.
 Battery exhausted.	Cannot shoot. Recharge or replace with a fully charged battery.

Battery level indicator

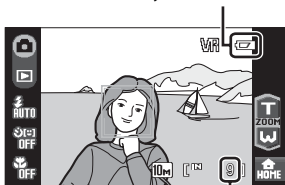

Number of exposures remaining

Number of Exposures Remaining





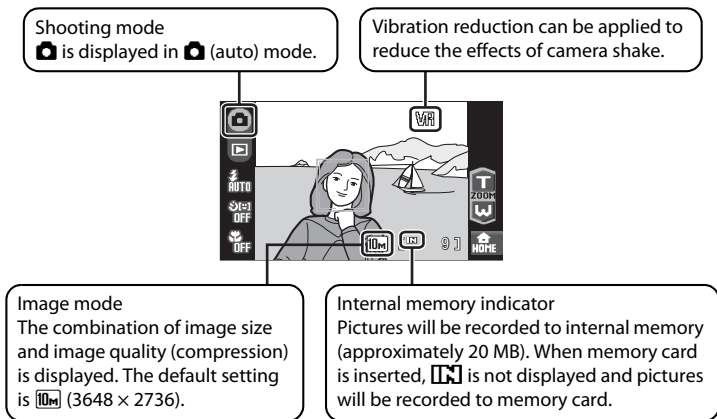



The number of pictures that can be stored depends on the capacity of the internal memory or memory card and image mode setting ( 117).

Indicators Displayed in (Auto) Mode





The information on indicators in the monitor during shooting will display only for a few seconds ( 139).



Functions Available in (Auto) Mode

In  (auto) mode, macro mode ( 35) can be applied and pictures can be taken using the flash mode ( 30), self-timer ( 32), and smile timer ( 33). Tap  in  (auto) mode to display the HOME screen ( 12) and tap the menu control to specify settings for all shooting menu items ( 115).

Vibration Reduction

Vibration reduction ( 142) in the setup menu ( 133), when **On** (default setting) is selected, can be applied to effectively reduce blur, caused by slight hand movement known as camera shake, that commonly occurs when shooting with zoom applied or at slow shutter speeds.

Set **Vibration reduction** to **Off** when using a tripod to stabilize the camera during shooting.

To reduce the effects of camera shake when recording movies, enable **Electronic VR** ( 90) from the movie menu ( 88).

Step 2 Frame a Picture

1 Ready the camera.

Hold the camera steadily in both hands, keeping your fingers and other objects away from the lens, flash and self-timer lamp.

When taking pictures in “tall” orientation, turn the camera so that the built-in flash is above the lens.

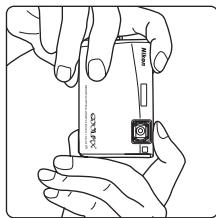
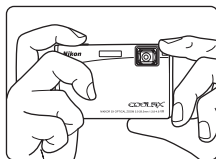

2 Frame the picture.

When the camera recognizes a face, a yellow double border (focus area) will be displayed around that face.

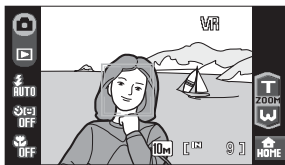

When the camera detects more than one face, a double border will be displayed around the face closest to the camera, and single borders around the others.

When shooting pictures of subjects other than people, or framing a subject with which no face is recognized, the camera automatically selects the focus area (one of nine) containing the subject closest to the camera when the shutter-release button is pressed halfway. When the shutter-release button is pressed halfway, the focus area at which focus has been acquired will be displayed.



Touch AF/AE

Tap a subject in the monitor to select the focus area at which the camera should focus and set the exposure.

- A single border or a double border will be displayed at the position tapped.
- To disable the focus area applied using the touch AF/AE function, tap the  icon.
- If a position at which focus cannot be acquired is tapped,  will be displayed in the monitor. Tap another position within .

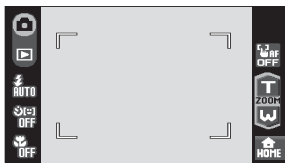

Using the Zoom

Tap **T** or **W** to activate optical zoom. Tap **T** to zoom in so that the subject fills a larger area of the frame, or **W** to zoom out, increasing the area visible in the frame.

A zoom indicator is displayed when **T** or **W** is tapped.

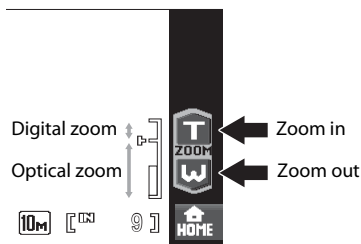

Digital Zoom

When the camera is zoomed in to the maximum optical zoom position, touching and holding **T** triggers digital zoom. The subject is magnified up to 4x the maximum optical zoom ratio.

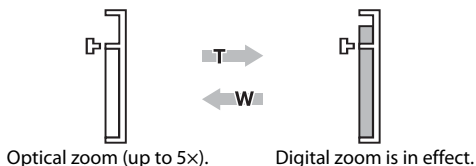

The focus area is not displayed when digital zoom is in effect, and focus will be in the center of the screen.



Digital Zoom and Interpolation

Unlike optical zoom, digital zoom uses a digital imaging process known as interpolation to magnify images, resulting in slight deterioration of picture quality.

Interpolation is applied at zoom positions beyond **P**. When zoom is increased beyond the **P** position, interpolation is initiated and the zoom indicator turns yellow to indicate that interpolation is being applied. The position of **P** moves to the top as image size decreases, allowing for confirmation of the zoom positions at which shooting without interpolation is possible at the current image mode setting ( 116).

Digital zoom can be disabled from the **Digital zoom** option ( 143) in the setup menu ( 133).

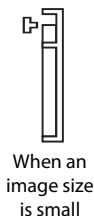

Step 3 Focus and Shoot

1 Press the shutter-release button halfway (📷 4).

Focus is locked when the shutter-release button is pressed halfway. When focus is locked, the active focus area glows green.

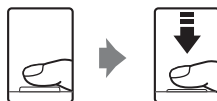

When a face is recognized:

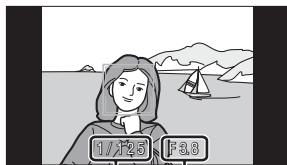

Shutter speed Aperture

When no face is recognized:



Focus indicator

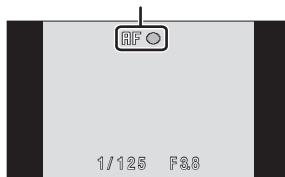

When digital zoom is used, the focus area is not displayed and the camera focuses at the center of the frame. Once focus has been acquired, the focus indicator will glow green.

The shutter speed and aperture are displayed when the shutter-release button is pressed halfway.

The focus and exposure remain locked while the shutter-release button is pressed halfway.

When the shutter-release button is pressed halfway, and then the double border blinks in Face priority, or the focus area or the focus indicator blinks red, the camera is unable to focus. Change the composition and press the shutter-release button halfway again.

See **AF area mode** (📷 124) or “Shooting with Face Priority” (📷 126) for more information about Face Priority.

2 Press the shutter-release button the rest of the way down.

The picture will be recorded to the memory card or internal memory.



✔ During Recording

While pictures are being recorded, the number of exposures remaining will blink. **Do not open the battery-chamber/memory card slot cover** while pictures are being recorded. Cutting power or removing the memory card in these circumstances could result in loss of data or in damage to the camera or card.

✔ Autofocus

Autofocus may not perform as expected in the following situations. In some rare cases, the subject may not be in focus despite the fact that the focus area or the focus indicator glows green:

- Subject is very dark
- Objects of sharply differing brightness are included in the scene (e.g. the sun is behind the subject and is in deep shadow)
- No contrast between the subject and surroundings (e.g. when the subject is standing in front of a white wall, wearing a white shirt)
- Several objects are at different distances from the camera (e.g. the subject is inside a cage)
- Subject is moving rapidly

In the situations noted above, try pressing the shutter-release button halfway to refocus several times, or focus on another subject and use focus lock (🔒 125). When using focus lock, be sure that the distance between the camera and the subject with which focus was locked is the same as that for the actual subject.

📄 Blink Warning

If the blink warning screen is displayed shortly after a picture is taken in face priority mode, the eyes of human subjects may have been closed when the picture was taken. Check the picture and decide whether or not another picture should be taken.

- The portrait subject, whose eyes may have been closed when the picture was taken, will be framed by a yellow border in the blink warning screen.
- Tap the picture currently displayed, or press the shutter-release button, to return to shooting mode.

See “Blink Warning” (🔍 146) or “Operating the Blink Warning Screen” (🔍 147) for more information.

💡 AF-assist Illuminator and Flash

If the subject is poorly lit, the AF-assist illuminator (🔍 142) may light by pressing the shutter-release button halfway, or the flash (🔍 30) may fire by pressing the shutter-release button all the way down.

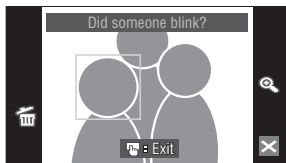

Step 4 Playing Back and Deleting Pictures

Playing Back Pictures (Playback Mode)

Tap .

Shooting

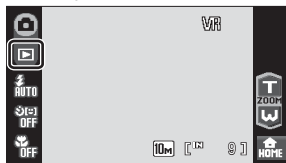

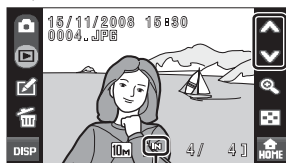

Playback





Internal memory indicator

The last picture taken will be displayed in full-frame playback mode.

Tap  to display photo information and all available controls ( 29).

When  is displayed, pictures stored in the internal memory will be displayed. When memory card is inserted,  is not displayed and pictures stored on the memory card will be displayed.

Drag the current picture to display previous or subsequent picture.

Previous or subsequent picture can also be viewed by tapping  or .

Pictures may be displayed briefly at low resolution while being read from the memory card or internal memory.

Tap the shooting mode control or press the shutter-release button to return to shooting mode.

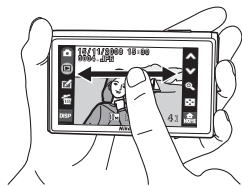

Deleting Pictures

- 1 Tap  to delete the picture currently displayed in the monitor.

If  is not displayed, tap  to turn on the information display ( 29).

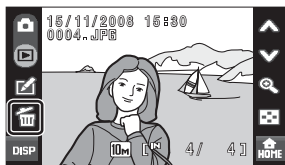

- 2 Tap **Yes**.

To exit without deleting the picture, tap **No**.

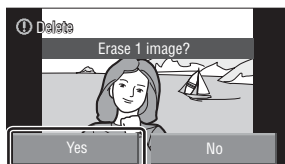





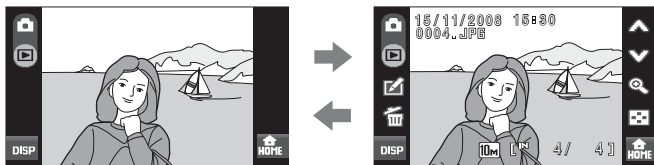





Turning Photo Information and Controls Display On and Off

Tap **DISP** to toggle photo information and available controls on and off.







Options Available Playback Mode



The following options are available in full-frame playback mode.

Option	Control	Description	
Playback zoom		Tap  to enlarge view of picture currently displayed in the monitor up to about 10x. Pictures can also be enlarged by tapping the picture currently displayed. Tap  to return to full-frame playback.	53
View thumbnails		Tap  to display 4, 9, 16, or 25 picture thumbnails.	52
Edit pictures		Tap  to display the retouch menu.	54
Switch to shooting mode	Shooting mode control	Tap the shooting mode control ( 8) to switch to the last shooting mode used. The shutter-release button can also be pressed to return to the last shooting mode used.	–
Switch to the HOME screen		The shooting, playback, and setup menus can be displayed from the HOME screen.	12

Viewing Pictures

- Pictures stored in the internal memory can only be viewed if no memory card is inserted.
- Pictures taken in "tall" orientation will be rotated automatically ( 144). The rotating direction can be changed from the **Rotate image** option ( 131) in the playback menu ( 129). When the camera is rotated, the picture displayed is also rotated ( 11).
- When the monitor has turned off in standby mode to save power, press the power switch or the shutter-release button to reactivate it ( 144).

Deleting Multiple Pictures

Multiple pictures can be deleted from the **Delete** option ( 130) in the playback menu ( 129), or by tapping  in thumbnail playback mode (52) or sort mode (67, 69).

Using the Flash

The flash has a range of approx. 0.6 to 3.8 m (2 to 12 ft.) when the camera is zoomed out all the way. With maximum optical zoom applied, the range is approx. 1.0 to 3.0 m (3 ft. 4 in. to 9 ft.) (when **ISO sensitivity** is set to **Auto**). The following flash modes are available.

AUTO Auto

Flash fires automatically when lighting is poor.

Auto with red-eye reduction

Reduces “red-eye” in portraits ( 31).

Off

Flash will not fire even when lighting is poor.

Fill flash

Flash fires when a picture is taken. Use to “fill-in” (illuminate) shadows and back-lit subjects.

Slow sync

 **AUTO** (auto) is combined with slow shutter speed.

Flash illuminates main subject; slow shutter speeds are used to capture background at night or under dim light.

Setting the Flash Mode

1 Tap flash mode control.

The flash menu is displayed.

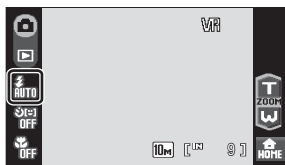

2 Tap the desired flash mode control.

The icon for the selected flash mode is displayed.

When  is tapped, the menu will close and the monitor display will return to shooting mode without changing the flash mode.

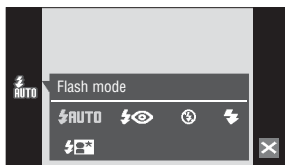

✓ Shooting When Lighting is Poor and the Flash is Disabled (🔇)

- Use of a tripod is recommended to stabilize the camera during shooting and avoid the effects of camera shake. Set **Vibration reduction** (🔇 142) in the setup menu (🔧 133) to **Off** when using a tripod to stabilize the camera during shooting.
- The **ISO** indicator is displayed when the camera automatically increases sensitivity. Pictures taken when **ISO** is displayed may be slightly mottled.

✓ Note on Using the Flash

When using the flash, reflections from dust particles in the air may appear as bright spots in pictures. To reduce these reflections, set the flash to 🚫 (Off).

📌 The Flash Indicator

The flash indicator shows flash status when the shutter-release button is pressed halfway.

- **On:** Flash will fire when picture is taken.
- **Blinks:** Flash charging. Wait a few seconds and try again.
- **Off:** Flash will not fire when picture is taken.

If the battery is low, the monitor display will turn off, and remain off, until the flash is fully charged.



📌 The Flash Mode Setting

The default flash mode setting varies with shooting mode.

- 📷 (auto) mode: **🔇 AUTO** Auto
- **SCENE** (scene): varies with the selected scene mode (🔧 37)
- 🎞️ (time-lapse movies): **🔇 AUTO** Auto

The flash mode setting applied in 📷 (auto) mode is stored in the camera's memory even after the camera is turned off, and reapplied the next time 📷 (auto) mode is selected.

📌 Red-eye Reduction

This camera uses advanced red-eye reduction ("In-Camera Red-Eye Fix"). The flash fires repeatedly at low intensity before the main flash, reducing red-eye. The camera then analyzes the picture; if red-eye is detected, the affected area will be processed to further reduce red-eye before the picture is saved. Note that because there is a slight lag between the shutter-release button being pressed and the picture being shot, this mode is not recommended when a quick shutter response is required. The time before the next picture can be shot also increases slightly. Advanced red-eye reduction may not produce the desired results in all situations. In extremely rare instances, areas not subject to red-eye may be affected by advanced red-eye reduction processing; in these cases, choose another mode and try again.

Taking Pictures with the Self-timer

The camera is equipped with a two- or ten-second timer for self-portraits. This feature is useful for reducing the effects of camera shake that occurs when pressing the shutter-release button.

When using the self-timer, use of a tripod is recommended. Turn vibration reduction (📷 142) off when using a tripod.

1 Tap self-timer control.

The self-timer menu is displayed.

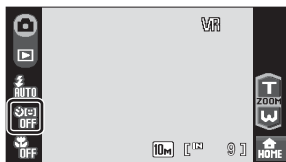

2 Tap 10s or 2s.

10s (ten seconds): Suited for important occasions (such as weddings)

2s (two seconds): Suited for preventing camera shake

The mode selected for self-timer is displayed.

When **X** is tapped, the menu will close and the monitor display will return to shooting mode without changing the self-timer setting.

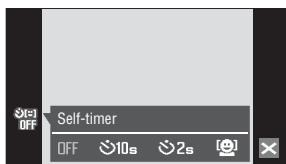

3 Frame the picture and press the shutter-release button halfway.

Focus and exposure will be set.



4 Press the shutter-release button the rest of the way down.

The self-timer starts and the number of seconds remaining until the shutter is released is displayed in the monitor. The self-timer lamp will blink. The lamp stops blinking one second before the shutter is released.

When the shutter is released, the self-timer will be set to **OFF**.

To stop the timer before a picture is taken, press the shutter-release button again.

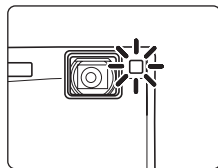
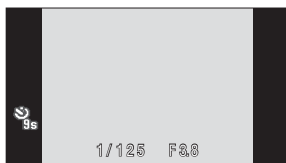

Automatic Shooting of a Smiling Face (Smile Timer)

The camera detects a smiling face to shoot the face automatically.

1 Tap self-timer control to display self-timer menu, and tap .

When  is tapped, the menu will close and the monitor display will return to shooting mode without changing the self-timer setting.

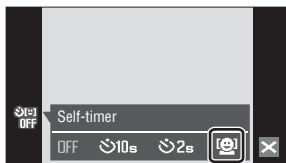

2 Frame a picture.

When the camera detects a face looking toward the camera, the focus area containing the face will be displayed with a yellow double border. The camera focuses on the face framed by the double border. The double border will glow green and focus will be locked.



When the camera detects more than one face, the face closest to the camera is framed by a double border and the others by single borders. When a face framed by a single border is tapped, the camera focuses on the position indicated by tapping the touch panel. Up to three faces can be detected.

Digital zoom is not available.

3 Press the shutter-release button all the way down.

The camera begins searching for smiling faces five seconds after the shutter-release button is pressed. If the camera detects a smiling face, framed by a border, the smile indicator increases and the shutter is released automatically. If more than one face is recognized, the shutter is released when the camera detects that all of the recognized faces are smiling.

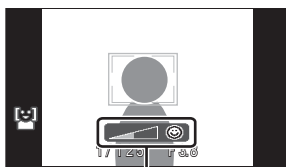

Smile indicator

If a face is tapped in step 2, when the camera detects a smiling face framed by the double border, the smile indicator increases and the shutter is released automatically.

When the shutter-release button is pressed, the number of seconds remaining until the camera begins searching for smiling faces is displayed in the monitor. The self-timer lamp will blink. The lamp stops blinking one second before the camera begins searching for smiling faces.

When the shutter is released, automatic shooting, with which the camera detects a smiling face and releases the shutter automatically, will be performed repeatedly.

4 Press the shutter-release button all the way down again to exit smile timer mode.



Shooting also stops in the following situations:

- When nine pictures have been taken
- When five minutes have been passed since the shutter-release button was pressed in step 3
- When the internal memory or memory card becomes full

✓ Note on the Smile Timer

The smile timer can be activated in  (auto) mode (p. 22), and **Portrait** (p. 37) and **Night portrait** (p. 38) scene modes. The smile indicator is not displayed in **Night portrait** scene mode.

Face Priority and Smiling Face Detection Features

When the camera is pointed at a face looking toward the camera in smile timer mode, the face is automatically recognized and the smiling face of the recognized one is detected.

- In some shooting conditions, Face priority will not take effect and smiling face cannot be detected.
- See “Shooting with Face Priority” (p. 126) for more information about the face priority function.

Macro Mode

Macro mode is used for taking pictures of objects as close as 9 cm (3.6 in.). Note that the flash may be unable to light entire subject at distances of less than 60 cm (2 ft.).

1 Tap macro mode control.

The macro menu is displayed.

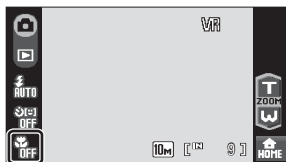

2 Tap ON.

When  is tapped, the menu will close and the monitor display will return to shooting mode without changing the macro mode setting.

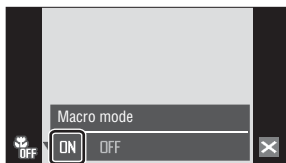

3 Tap or to frame the picture.

The camera can focus at a distance of 9 cm (3.6 in.) at the zoom position at which the zoom indicator glows green (the zoom indicator is before ).

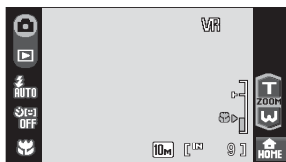

Macro Mode

In macro mode, the camera automatically focuses continuously until focus and exposure are locked by pressing the shutter-release button halfway.

The Macro Mode Setting

The macro mode setting applied in  (auto) mode is stored in the camera's memory even after the camera is turned off, and reapplied the next time  (auto) mode is selected.

Shooting in Scene Mode

Camera settings are automatically optimized for the selected subject type. The following scene modes are available.

Scene auto selector	Portrait	Landscape	Sports	Night portrait
Party/indoor	Beach/snow	Sunset	Dusk/dawn	Night landscape
Close-up	Food	Museum	Fireworks show	Copy
Draw	Backlight	Panorama assist	Voice recording*	

* See "Voice Recordings" (94) for details.

Setting the Scene Mode

- 1 Tap the shooting mode control in shooting mode to display the shooting mode menu, and then tap .

The scene selection menu will be displayed.

The scene selection menu can also be displayed by tapping the scene mode control in the HOME screen, displayed by tapping .

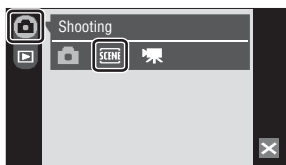

- 2 Tap the desired scene control.

Tap to display the help selection screen. Tap a scene icon to view a description of that scene mode.

When is tapped, the menu will close and the monitor display will return to shooting mode without changing the scene mode.

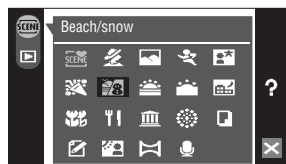

- 3 Frame the subject and shoot.

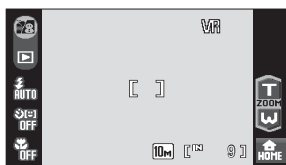

The Scene Menu

Tap the menu control in the HOME screen, displayed by tapping during shooting in scene mode, to display the scene menu. **Image mode** (116), and **Exp. +/-** (exposure compensation) (120) can be adjusted in the scene menu. Changes made to the image mode setting apply to (auto) mode.

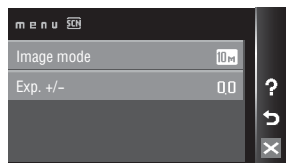

Features

Scene auto selector

By simply framing a picture, the camera automatically selects the optimum scene mode. See “Shooting in the Scene Mode Selected by the Camera (Scene Auto Selector)” (📖 43) for more information.

	 AUTO ¹		Off ²		Off ³
---	---	---	------------------	---	------------------

¹ The camera automatically selects the optimum flash mode setting for the scene mode it has selected. Can be changed to 📖.

² Other settings can be selected.

³ Changed to On when the camera selects **Close-up** scene mode.

Portrait

Use this mode for portraits in which the main subject stands out clearly. Portrait subjects exhibit smooth, natural-looking skin tones. See “Shooting in Portrait/Night Portrait Scene Mode” (📖 45) for more information.



	 *		Off*		Off
---	---	---	------	---	-----

* Other settings can be selected.

Landscape

Use this mode for vivid landscapes and cityscapes.



- Camera focuses at infinity. The focus area or focus indicator (📖 26) always glows green when the shutter-release button is pressed halfway. Note, however, that objects in the foreground may not always be in focus.
- The AF-assist illuminator does not light, regardless of the AF assist setting (📖 142).



			Off*		Off
---	---	---	------	---	-----

* Other settings can be selected.



Icons Used for Descriptions

The following icons are used for descriptions in this section: , flash mode (📖 30); , self-timer (📖 32); , macro mode (📖 35).

Shooting in Scene Mode

Sports

Use this mode for dynamic action shots that freeze the action in a single shot and record motion in a series of pictures.

- The camera focuses continuously until focus is locked by pressing the shutter-release button halfway.
- While the shutter-release button is held down, up to 7 pictures are taken at a rate of about 1.2 frames per second (fps) when image mode is set to  **Normal (3648)**.
- The maximum frame rate with continuous shooting may vary depending upon the current image mode setting and the memory card used.
- The AF-assist illuminator does not light, regardless of the AF assist setting ( 142).



Off



Off

Night portrait



Use this mode to achieve a natural balance between the main subject and background lighting in portraits taken at night. See “Shooting in Portrait/Night Portrait Scene Mode” ( 45) for more information.



Off²



Off

¹ Fill flash with slow sync and red-eye reduction.

² Other settings can be selected.

Party/indoor

Captures the effects of candlelight and other indoor background lighting.

- Camera focuses on subject in center of frame.
- As pictures are easily affected by camera shake, hold the camera steadily. In a dark place, the use of a tripod is recommended. Set **Vibration reduction** ( 142) to **Off** when using a tripod.





Off²



Off

¹ May automatically switch to slow sync with red-eye reduction when background is dimly lit. Other settings can be selected.

² Other settings can be selected.

: For those scene modes with , use of a tripod is recommended. Set **Vibration reduction** ( 142) to **Off** when using a tripod.

: For those scene modes with , noise reduction is carried out automatically so the time taken to save an image will be longer than usual.

Beach/snow

Captures the brightness of such subjects as snowfields, beaches, or sunlit expanses of water.

- Camera focuses on subject in center of frame.



* Other settings can be selected.

Sunset

Preserves the deep hues seen in sunsets and sunrises.



- Camera focuses at the center of the screen.



* Other settings can be selected.



Dusk/dawn

Preserves the colors seen in the weak natural light before sunrise or after sunset.

- Camera focuses at infinity. When the shutter-release button is pressed halfway, the focus area or focus indicator ( 26) always glows green; however, focus may not be set for near subjects, while the camera focuses at infinity.
- The AF-assist illuminator does not light, regardless of the AF assist setting ( 142).



* Other settings can be selected.

: For those scene modes with , use of a tripod is recommended. Set **Vibration reduction** ( 142) to **Off** when using a tripod.



: For those scene modes with **NR**, noise reduction is carried out automatically so the time taken to save an image will be longer than usual.

Shooting in Scene Mode

Night landscape



Slow shutter speeds are used to produce stunning night landscapes.

- Camera focuses at infinity. When the shutter-release button is pressed halfway, the focus area or focus indicator ( 26) always glows green; however, focus may not be set for near subjects, while the camera focuses at infinity.
- The AF-assist illuminator does not light, regardless of the AF assist setting ( 142).



Off*







Off

* Other settings can be selected.

Close-up

Photograph flowers, insects and other small objects at close range.

- Macro mode ( 35) will be turned on and the camera automatically zooms to the position at the closest distance at which the camera can focus.
- The camera can focus at distances as close as 9 cm (3.6 in.) at the wide-angle zoom position at which  glows green (the zoom indicator is before ). The closest distance at which the camera can focus varies depending upon zoom position.
- The touch panel can also be tapped to choose an object on which the camera will focus ( 24).
- The camera focuses continuously until focus is locked by pressing the shutter-release button halfway.
- As pictures are easily affected by camera shake, check the **Vibration reduction** ( 142) setting and hold the camera steadily.



 AUTO*



Off*



On

* Other settings can be selected. Note that the flash may be unable to light entire subject at distances of less than 60 cm (2 ft.)

Food

Use when taking pictures of food. See "Taking Pictures in Food Mode" ( 47) for details.

- The touch panel can also be tapped to choose an object on which the camera will focus ( 24).





Off*



On



* Other settings can be selected.

 For those scene modes with , use of a tripod is recommended. Set **Vibration reduction** ( 142) to **Off** when using a tripod.

 For those scene modes with , noise reduction is carried out automatically so the time taken to save an image will be longer than usual.

Museum

Use indoors where flash photography is prohibited (for example, in museums and art galleries) or in other settings in which you do not want to use the flash.

- Camera focuses on subject in center of frame.
- BSS (best shot selector) ( 121) is used when shooting.
- As pictures are easily affected by camera shake, check the **Vibration reduction** ( 142) setting and hold the camera steadily.
- The AF-assist illuminator does not light, regardless of the AF assist setting ( 142).



Off*





Off*

* Other settings can be selected.

Fireworks show



Slow shutter speeds are used to capture the expanding burst of light from a firework.

- Camera focuses at infinity. When the shutter-release button is pressed halfway, the focus indicator ( 26) always glows green; however, focus may not be set for near subjects, while the camera focuses at infinity.
- Exposure compensation ( 120) cannot be adjusted.
- The AF-assist illuminator does not light, regardless of the AF assist setting ( 142).



Off



Off

Copy

Provides clear pictures of text or drawings on a white board or in print.

- Camera focuses on subject in center of frame.
- Use macro mode ( 35) to focus at short ranges.
- Colored text and drawings may not show up well.





Off*



Off*

* Other settings can be selected.

: For those scene modes with , use of a tripod is recommended. Set **Vibration reduction** ( 142) to **Off** when using a tripod.

Shooting in Scene Mode

Draw

Write a memo, or draw a picture, on the touch panel display and save it as an image. See "Using the Draw Option" ( 49) for more information.



Backlight

Use when light is coming from behind your subject, throwing features or details into shadow. The flash fires automatically to "fill in" (illuminate) shadows.

- Camera focuses on subject in center of frame.



* Other settings can be selected.

Panorama assist



Use when taking a series of pictures that will later be joined to form a single panorama using the supplied Panorama Maker software. See "Taking Pictures for a Panorama" ( 50) for more information.



* Other settings can be selected.

Shooting in the Scene Mode Selected by the Camera (Scene Auto Selector)

By simply framing a picture, the camera automatically selects the optimum scene mode for simpler shooting.

When the camera is aimed at a subject in  scene auto selector mode, the camera automatically selects one of the following scene modes:

- **Auto**  22
- **Portrait**  37
- **Landscape**  37
- **Night portrait**  38
- **Night landscape**  40
- **Close-up**  40
- **Backlight**  42

For more information regarding details of these scene modes, see the reference pages indicated above.

Taking Pictures in Scene Auto Selector Mode

- 1** Tap the shooting mode control in shooting mode to display the shooting mode menu, and tap .

The scene selection menu will be displayed.

The scene selection menu can also be displayed by tapping the scene mode control in the HOME screen, displayed by tapping .

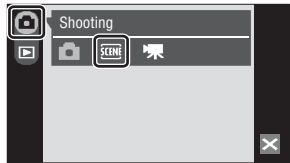

- 2** Tap .

The camera enters scene auto selector mode.



3 Frame the subject and take the picture.

When the camera automatically selects a scene mode, the shooting mode icon changes to that for the scene mode currently enabled.

Shooting mode control

: Auto	: Night landscape
: Portrait	: Close-up
: Landscape	: Backlight
: Night portrait	

When more than one face is framed by a border, tap a border to choose the face on which the camera focuses.

Press the shutter-release button halfway to set focus and exposure.

Press the shutter-release button the rest of the way down to take the picture.

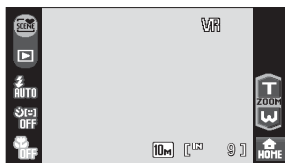

✓ Notes on Scene Auto Selector Mode

Depending upon shooting conditions, the camera may not select the desired scene mode. Should this occur, switch to (auto) mode (22) or select the desired scene mode manually (37).

Flash Mode in Scene Auto Selector Mode

AUTO (Auto) (default setting) and (Off) flash mode settings can be applied (30).

- When **AUTO** (Auto) is applied, the camera automatically selects the optimum flash mode setting for the scene mode it has selected.
- When (Off) is applied, the flash does not fire, regardless of shooting conditions.

Functions Restricted in Scene Auto Selector Mode

- Digital zoom is not available.
- Macro mode is disabled. The macro mode turns on when the camera selects **Close-up** scene mode.
- Smile timer is not activated.
- The camera selects the focus area (out of nine) containing the subject closest to the camera when the camera selects (Close-up). When the shutter-release button is pressed halfway, the active focus area is displayed in the monitor.

Shooting in Portrait/Night Portrait Scene Mode

- 1 Tap the shooting mode control in shooting mode to display the shooting mode menu, and tap **SCENE**.

The scene selection menu will be displayed.

The scene selection menu can also be displayed by tapping the scene mode control in the HOME screen, displayed by tapping **HOME**.

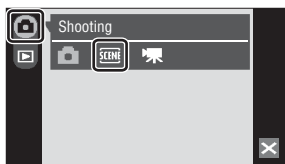

- 2 Tap  or .



- 3 Frame the picture.

When a face looking toward the camera is recognized, a yellow double border (focus area) will be displayed around that face).

When the camera detects more than one face, a double border will be displayed around the face closest to the camera, and single borders around the others. When a face framed by a single border is tapped, the single border changes to a double border and the camera will focus on that face.

If no face is recognized, the camera will focus on the subject at the center of the frame.

The smile indicator is displayed in **Portrait** scene mode. If the camera detects a smiling face of the human subject framed by a double border, the smile indicator increases or decreases. The smile indicator is not displayed when the camera selects **Portrait** in **Scene auto selector** scene mode.

Portrait one-touch zoom ( 46) is available.

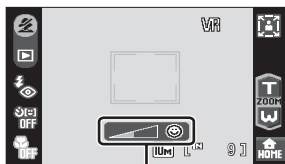

Smile indicator

- 4 Press the shutter-release button to take the picture.

Focus is locked when the shutter-release button is pressed halfway, and a picture is taken when the shutter-release button is pressed the rest of the way down.

When the camera is unable to focus, the focus area blinks red. Change the composition and press the shutter-release button halfway again.

✓ Notes on Portrait/Night Portrait Scene Mode

- The flash mode in **Night portrait** scene mode is fixed to fill flash with slow sync and red-eye reduction.
- Macro mode (📷 35) is not available.
- Digital zoom is not available.

📝 Using the Smile Timer

The smile timer (📷 33) can be activated in **Portrait** or **Night portrait** scene mode. However, the smile indicator is not displayed in **Night portrait** scene mode.

Portrait One-Touch Zoom

When a face is recognized in **Portrait** or **Night portrait** scene mode, simply tap 📷 to change the zoom position for the portrait subject whose face is framed by the double border as follows:

waist up zoom → bust up zoom → face zoom

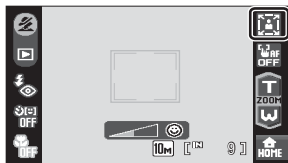

- The zoom position can be further adjusted by tapping **T** or **W** after it has been changed using the portrait one-touch zoom function.
- Zoom positions available vary with shooting distance.
- Portrait one-touch zoom is not available when the camera selects **Portrait** or **Night portrait** in **Scene auto selector** scene mode (📷 43).

Taking Pictures in Food Mode

Use this mode to take pictures of food.

- 1 Tap the shooting mode control in shooting mode to display the shooting mode menu, and tap **SCENE**.

The scene selection menu will be displayed.

The scene selection menu can also be displayed by tapping the scene mode control in the HOME screen, displayed by tapping **HOME**.

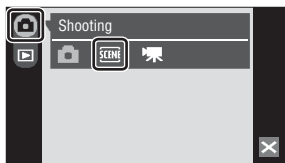

- 2 Tap **!**.



- 3 Tap the white balance control to choose the desired white balance.

The amount of red or blue tint can be adjusted.

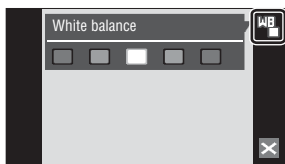

- 4 Frame the picture.

The camera can focus at distances as close as 9 cm (3.6 in.) at the wide-angle zoom position at which the zoom indicator glows green (the zoom indicator is before **▷**). The closest distance at which the camera can focus varies depending upon zoom position.

As pictures are easily affected by camera shake, check the **Vibration reduction** (**VR** 142) setting and hold the camera steadily.

Tap the subject on which the camera should focus to select the active focus area (**AF** 24).

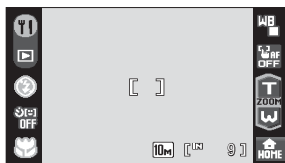

5 Press the shutter-release button to take the picture.

Focus is locked when the shutter-release button is pressed halfway, and a picture is taken when the shutter-release button is pressed the rest of the way down.

When the camera is unable to focus, the focus area blinks red. Change the composition and press the shutter-release button halfway again.



✓ Notes on Food Mode

Flash mode is disabled. Macro mode setting (Ⓜ 35) is fixed at **ON**.

📎 White Balance Setting in Food Mode

- Increasing the amount of red or blue will decrease illumination effects. Changing white balance in food mode will not affect white balance in the shooting menu (Ⓜ 118).
- The white balance setting applied in food mode is stored in the camera's memory even after the camera is turned off, and reapplied the next time food mode is selected.

Using the Draw Option

Write a memo, or draw a picture, on the touch panel display and save it as an image. The image is saved at an image size setting of TV screen (640 × 480).

- 1 Tap the shooting mode control in shooting mode to display the shooting mode menu, and tap **SCENE**.

The scene selection menu will be displayed.

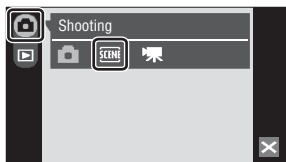

The scene selection menu can also be displayed by tapping the scene mode control in the HOME screen, displayed by tapping **HOME**.



- 2 Tap .



- 3 Draw pictures or write a memo.

Tap  to write text or draw pictures, and tap  to erase text or pictures ( 56).



- 4 Tap **OK**.



- 5 Tap **Yes**.

The memo is saved.

To cancel saving the memo, tap **No**.

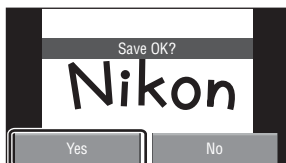

Taking Pictures for a Panorama

The camera focuses on the subject in the center of the frame. Use a tripod for best results. Set **Vibration reduction** (📷 142) to **Off** when using a tripod to stabilize the camera during shooting.

- 1 Tap the shooting mode control in shooting mode to display the shooting mode menu, and tap **SCENE**.

The scene selection menu will be displayed.

The scene selection menu can also be displayed by tapping the scene mode control in the HOME screen, displayed by tapping **HOME**.

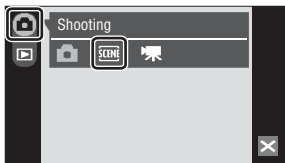

- 2 Tap .

The panorama direction icon (▶) is displayed to show the direction in which pictures will be joined.



- 3 Tap the direction.

Select how pictures will be joined together in the completed panorama; right (▶), left (◀), up (▲) or down (▼).

The selected panorama direction icon turns yellow. Apply flash mode (📷 30), self-timer (📷 32), and macro mode (📷 35) settings with this step, if necessary.



- 4 Shoot the first picture.

The first picture is superimposed in the first third of the monitor.



5 Shoot the second picture.

Compose the next picture so that one-third of the frame overlaps the previous picture.

Repeat until you have taken the necessary number of pictures to complete the scene.

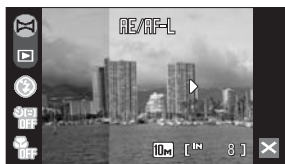

6 Tap **X** when shooting is completed.

The camera returns to step 3.



✓ Panorama Assist

Flash mode, self-timer, and macro mode settings cannot be adjusted after the first picture is taken. Pictures cannot be deleted, nor can zoom, image mode setting (ⓧ 116), or exposure compensation (ⓧ 120) be adjusted until the series is finalized.

The panorama series is terminated if the camera enters standby mode with the auto off function (ⓧ 144) during shooting. Setting the time allowed to elapse before the auto off function is enabled to a longer setting is recommended.

📷 AE/AF-L Indicator

AE/AF-L is displayed to indicate that white balance, exposure, and focus have been locked at the values set with the first shot. All pictures taken in a panorama series have the same white balance, exposure, and focus settings.





📷 Panorama Maker

Install Panorama Maker from the supplied Software Suite CD. Transfer pictures to a computer (ⓧ 101) and use Panorama Maker (ⓧ 104) to join them in a single panorama.

📷 More Information

See "Image/Sound File and Folder Names" (ⓧ 151) for more information.









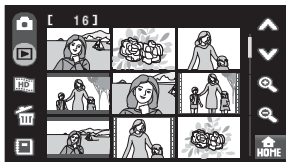







Viewing Multiple Pictures: Thumbnail Playback

Tap  in full-frame playback mode ( 28) to display pictures in “contact sheets” of thumbnail images.

- If  is not displayed in full-frame playback mode, tap .

The following operations can be performed while thumbnails are displayed.





To	Control	Description	
Scroll the screen	 , 	Tap  or  .	–
Decrease number of picture thumbnails displayed		Tap  to decrease number of picture thumbnails displayed: 25 → 16 → 9 → 4	–
Increase number of picture thumbnails displayed		Tap  to increase number of picture thumbnails displayed: 4 → 9 → 16 → 25	–
Create an HD Pictmotion slide show		Tap  to display the HD Pictmotion slide show creation screen.	82
Delete pictures		Tap  to display the picture selection screen for deletion and delete the picture.	130
Switch to sort mode		Tap  to display the sort menu.	66, 69, 78
Switch to the HOME screen		Tap  to switch to the HOME screen.	12
Switch to full-frame playback	–	Tap the picture to display the picture full frame.	–
Switch to shooting mode	Shooting mode control	Tap the shooting mode control to switch to the last shooting mode used. The shutter-release button can also be pressed to return to the last shooting mode used.	–

Thumbnail Playback for Movies

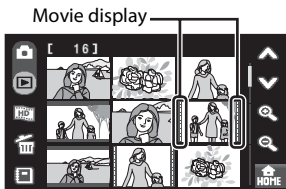
Movies are displayed as film frames.



Taking a Closer Look: Playback Zoom









Tapping the picture or  during full-frame playback mode ( 28) zooms the current picture, with the center of the picture displayed in the monitor.

The guide displayed in the right bottom in the monitor will show which part of the image is currently displayed.









- If  is not displayed in full-frame playback mode, tap .

The following operations can be performed while pictures are zoomed in.

To	Control	Description	
Zoom in		Tap  to enlarge view of picture currently displayed in monitor, up to about 10x.	-
Zoom out		Tap  . When the magnification ratio reaches 1x, the display returns to full-frame playback mode.	-
Change the display area	-	The area of the picture currently displayed can be changed by dragging the picture.	-
Delete pictures		Tap  to delete the picture.	28
Switch to full-frame playback		Tap  .	28
Switch to shooting mode	-	Press the shutter-release button to switch to the last shooting mode used.	-

Pictures Taken Using the Face-Priority Function

When zooming in (playback zoom) on a picture taken using the face-priority function ( 126) by tapping the picture or , the picture will be enlarged with the face detected with shooting at the center of the monitor.

- If more than one face was detected, the picture will be enlarged with the face on which focus was acquired at the center of the monitor. Tap  or  to display other faces that were detected.
- When  or  is tapped to adjust the zoom ratio, the center of the picture (normal playback zoom display), rather than the face, is displayed at the center of the monitor.



Editing Pictures

Use the COOLPIX S60 to edit pictures in-camera and store them as separate files (📷 151). The editing features described below are available.

Editing function	Description
Paint (📷 55)	Draw pictures or affix stamps on the pictures.
Trim (📷 57)	Enlarge the image or refine the composition and create a copy containing only the portion visible in the monitor.
Stretch (📷 59)	Stretch the current picture horizontally to make the subject appear thinner or wider, and save the stretched picture as a copy.
Perspective control (📷 60)	Control the sense of perspective in the picture. Apply perspective control similar to that available with shift lenses. This option is suited to pictures of buildings or architecture.
D-Lighting (📷 61)	Create a copy of the current picture with enhanced brightness and contrast, brightening dark portions of the picture.
Color options (📷 62)	Make colors more vivid or record pictures in monochrome.
Small picture (📷 63)	Create a small copy of pictures suitable for use on web pages or as e-mail attachments.

Picture Editing

- The editing functions of this camera cannot be used for pictures taken with another make or model of camera.
- If a copy created using this camera is viewed on a different digital camera, the picture may not be displayed or may not be transferred to a computer.
- Editing functions are not available when there is not enough free space in the internal memory or on the memory card.

Restrictions on Picture Editing

- Copies created with editing functions other than the paint function cannot be further edited with the same function used to create them.
- Copies created with the paint, stretch, perspective control, D-Lighting, or color options function can be further modified only with the paint, crop, or small picture function.
- Cropped copies cannot be further modified using other editing functions. However, copies saved at a size of 640 × 480 or larger can be further modified with the paint function and copies saved at a size of 1024 × 768 or larger can be further modified with the small picture function.
- Only the crop function can be used to edit pictures taken at an image mode setting of 16:9.
- Small picture copies cannot be further modified using other editing functions.
- Images created with the draw option can be modified only with the paint or small picture function.

Original Pictures and Edited



- Copies created with editing functions are not deleted if the original pictures are deleted. The original pictures are not deleted if copies created with editing functions are deleted.
- Edited copies are stored with the same recording date and time as the original.
- Edited copies are not marked for printing (📷 111) or protecting (📷 131) as the original.

Paint Pictures

Draw pictures on images or affix stamps on images. Painted copies are stored as separate files.

- 1 Select the desired pictures from full-frame playback mode (📷 28) and tap .

The retouch menu is displayed.

If  is not displayed in full-frame playback mode, tap .

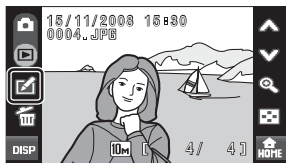

- 2 Tap .



- 3 Use the , , , and  tools to paint pictures.

For more information about using each tool, see "Write and Draw Pictures" (📷 56).

Tap  to undo the last operation applied using the pen, eraser, or stamp tool (up to the last five operations can be undone).

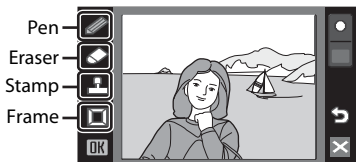

- 4 Tap **OK**.



- 5 Tap **Yes**.

A new, painted copy is created.

To cancel creating a painted copy, tap **No**.

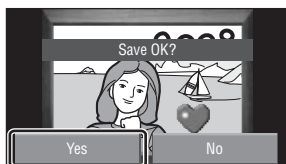

6 Choose a size.

Choose a size of copy from **3 M** (2048 × 1536) or **TV** (640 × 480).

When pictures taken at an image mode setting of **PC screen (1024)** or **TV screen (640)** are edited, or copies saved at a size smaller than 2048 × 1536 are further modified using the paint function, choose **TV** (640 × 480).

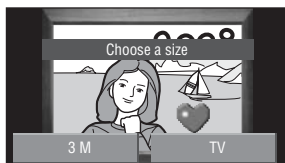

Using the Paint Tools

Write and Draw Pictures

Tap to write or draw pictures.

- Tap the thickness control to choose stroke weights.
- Tap the color control to choose a color.

Pen's color Pen's thickness

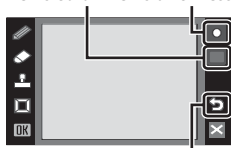

Undo

Eraser's size



Undo

Stamp size Stamp type

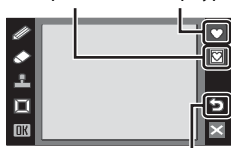

Undo

More on Playback

Erase Paint Additions

Tap to erase words you have written, pictures you have drawn, or stamps.

- Tap the eraser's size control to choose the size of the eraser.

Affix Stamps

Tap to affix a stamp.

- Tap the stamp type control to choose one of ten stamps.
- Tap the stamp size control to choose the size of the stamp.

Frame the Picture

Tap to frame a pictures.

- Tap or to display five different frames one at a time.

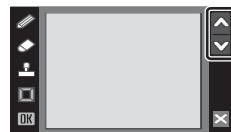

More Information



See "Image/Sound File and Folder Names" (📖 151) for more information.

Creating a Cropped Copy: Trim

Create a copy containing only portion visible in the monitor. Cropped copies are stored as separate files.

- 1 Select the desired pictures from full-frame playback mode (📷 28) and tap .

The retouch menu is displayed.

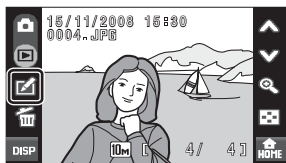

If  is not displayed in full-frame playback mode, tap .





- 2 Tap .



- 3 Frame the crop.

Tap  or  to adjust the crop size.

Drag the frame so that only the portion to be copied is visible in the monitor.

Tap  or  to change the aspect ratio of the visible portion of the picture.

Tap  to rotate the crop frame 90° and change the crop orientation.

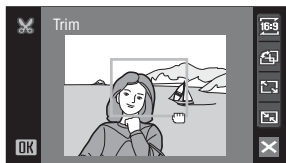

- 4 Tap **OK**.



5 Tap **Yes**.

A new picture, containing only the portion visible in the monitor, is created.

To cancel creating a cropped copy, tap **No**.

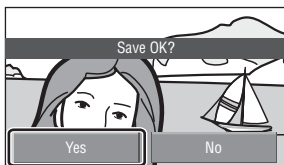



Image Size

As the area to be saved is reduced, the image size (pixels) of the cropped copy is also reduced.

When the size of the cropped copy is 320×240 or 160×120 , the small picture icon  or  is displayed on the left of the screen in full-frame playback mode.

More Information



See "Image/Sound File and Folder Names" ( 151) for more information.

Stretching Pictures: Stretch

Stretch pictures horizontally. Stretched copies are stored as separate files.

- 1 Select the desired pictures from full-frame playback mode (📷 28) and tap .

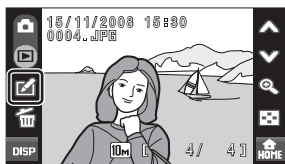

The retouch menu is displayed.

If  is not displayed in full-frame playback mode, tap .

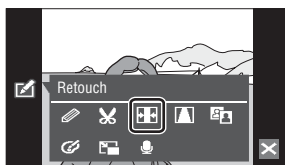

- 2 Tap .



- 3 Tap  or  to adjust stretch effects.

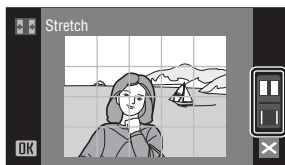

- 4 Tap **OK**.

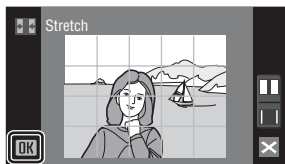

- 5 Tap **Yes**.

A new, stretched copy is created.

To cancel creating a stretched copy, tap **No**.

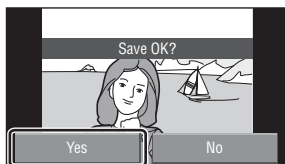

More Information

See "Image/Sound File and Folder Names" (📷 151) for more information.

Adding a Sense of Perspective: Perspective control

Enlarge a portion of the current picture to create a copy. Control the sense of perspective in the picture. Copies created with the perspective control function are stored as separate files.

- 1 Select the desired pictures from full-frame playback mode (📷 28) and tap .

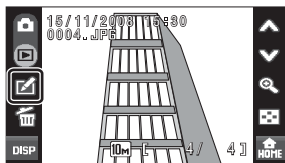

The retouch menu is displayed.

If  is not displayed in full-frame playback mode, tap .

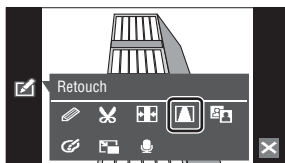

- 2 Tap .



- 3 Tap  or  to adjust perspective control.

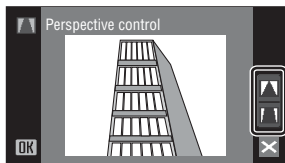

- 4 Tap **OK**.

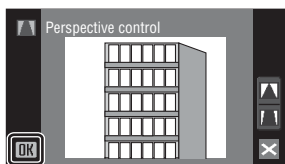

- 5 Tap **Yes**.

A new, edited copy is created.

To cancel creating a stretched copy, tap **No**.

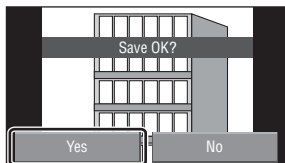



More Information

Enhancing Brightness and Contrast: D-Lighting

D-Lighting can be used to create copies with enhanced brightness and contrast, brightening dark portions of a picture. Enhanced copies are stored as separate files.

- 1 Select the desired picture from full-frame playback mode (📷 28) and tap .

The retouch menu will be displayed.

If  is not displayed in full-frame playback mode, tap .



- 2 Tap .

The original version will be shown on the left and the edited version will be shown on the right.

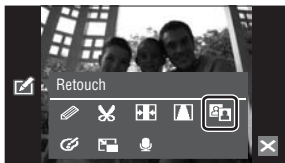

- 3 Tap **OK**.

A new copy with enhanced brightness and contrast is created.

To cancel D-Lighting, tap .

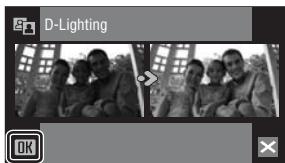







More Information

See "Image/Sound File and Folder Names" (📷 151) for more information.



Change Color Tones: Color Options

Change color tones of the pictures. Copies of which color tone has been changed are stored as separate files.

Options	Description
 Vivid color	Use to achieve a vivid, "photo print" effect.
 Black-and-white	Record pictures in black-and-white.
 Sepia	Record pictures in sepia tones.
 Cyanotype	Record pictures in cyan-blue monochrome.

- 1 Select the desired pictures from full-frame playback mode () 28) and tap .

The retouch menu is displayed.

If  is not displayed in full-frame playback mode, tap .

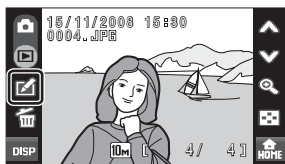

- 2 Tap .

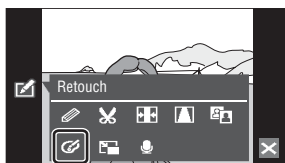

- 3 Tap the desired color option control and tap **OK**.

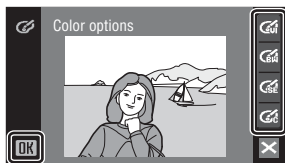

- 4 Tap **Yes**.

A new, copy of which color tone has been changed is created.

To cancel creating a copy, tap **No**.

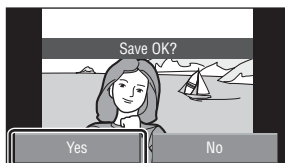





More Information

See "Image/Sound File and Folder Names" () 151) for more information.



Resizing Pictures: Small Picture

Create a small copy of the current picture. Small copies are stored as JPEG files with a compression ratio of 1:16. The following sizes are available.

Option	Description
 640x480	Suited to television playback.
 320x240	Suited to display on web pages.
 160x120	Suitable for e-mail attachments.

- 1 Select the desired pictures from full-frame playback mode ( 28) and tap .

The retouch menu is displayed.

If  is not displayed in full-frame playback mode, tap .

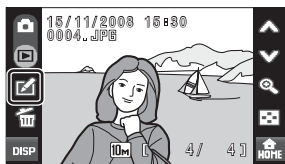

- 2 Tap .



- 3 Tap the control of the desired copy size and tap **OK**.



- 4 Tap **Yes**.

A new, smaller copy is created.

To cancel creating a copy, tap **No**.

The copy is displayed with a gray frame.



More Information

See "Image/Sound File and Folder Names" ( 151) for more information.



Voice Memos: Recording and Playback

Use the camera's built-in microphone to record voice memos for pictures.

Recording Voice Memos

- 1 Select the desired picture from full-frame playback mode (📷 28) and tap .

The retouch menu is displayed.

If  is not displayed in full-frame playback mode, tap .

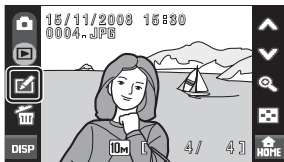

- 2 Tap .

The screen for recording a voice memo will be displayed.



- 3 Tap  to record a voice memo.

Recording ends after 20 seconds.

Do not touch the built-in microphone during recording.

During recording, **REC** blinks in the monitor.

When  is tapped during recording, recording ends.

When recording ends, the voice memo playback screen is displayed. Follow the instructions in step 3 of "Playing Voice Memos" (📷 65) to play the voice memo.

Tap  before or after recording a voice memo to return to full-frame playback mode.

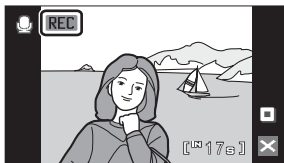



More Information

See "Image/Sound File and Folder Names" (📷 151) for more information.

Playing Voice Memos

Pictures for which voice memos have been recorded are indicated with  in fullframe playback mode.

- 1 Select the desired picture from full-frame playback mode ( 28) and tap .

The retouch menu is displayed.

If  is not displayed in full-frame playback mode, tap .

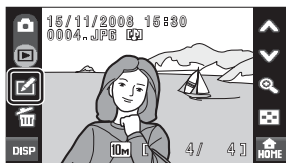



- 2 Tap .

The voice memo playback screen will be displayed.



- 3 Tap  to listen to the voice memo.

Playback ends when  is tapped.

Tap  during playback to display the volume menu and adjust speaker volume.

When  is tapped before playback, a new recording starts and the current voice memo will be overwritten.

Tap  before or after playing a voice memo to return to full-frame playback mode.



Deleting Voice Memos

When  is tapped in the voice memo playback screen, a confirmation dialog will be displayed.

Tap **Yes** to delete only the voice memo. To exit without deleting the voice memo, tap **No**.

Voice Memos



- When a picture with a voice memo attached is deleted, both the picture and its voice memo are deleted.
- This camera cannot be used to attach voice memos to pictures taken with another make or model of camera.



Finding Pictures by Shooting Date (List by Date Mode)

In list by date mode, pictures taken on a specified date can be displayed. All pictures taken on a specified date can be selected for deletion and printing. In full-frame playback mode, just as with playback mode, picture display can be enlarged, pictures can be edited, voice memos can be recorded or played back, and movies can be played back.

Selecting a Date in List by Date Mode

- 1 Tap  in the thumbnail display ( 52) to display the sort menu, and then tap **DATE**.

Dates for which pictures exist will be listed.

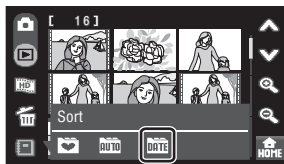

- 2 Tap the desired date.

Camera lists up to 29 dates. If pictures exist for more than 29 dates, all pictures recorded earlier than most recent 29 dates will be listed together as **Others**.

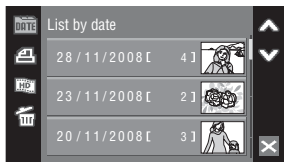

The picture for that date will be displayed as thumbnails.

Tap the picture to display the picture full frame.

Tap  to return to the list by date screen.

For more detailed information about operations available in list by date mode, see "Operations in List by Date Mode" ( 67).



Operations in List by Date Mode

The following operations are available in list by date mode.

Operations in the Date Selection Screen

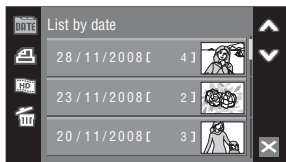

Option	Control	Description	
Scroll the screen	,	Tap or to scroll the screen.	–
Create print orders		Create print orders for all pictures taken on the selected date.	113
Create an HD Pictmotion slide show		Select a date and create an HD Pictmotion slide show.	84
Delete picture		Tap to delete all pictures taken on the selected date. Tap Yes in the confirmation dialog displayed to delete.	–
View sort menu		Tap to display the sort menu to switch to auto sort mode or favorite pictures mode.	69, 78
Switch to thumbnail display in playback mode		Tap to switch to thumbnail display in playback mode.	52
Switch to shooting mode	–	Press the shutter-release button to return to the last shooting mode used.	–

















Notes on List by Date Mode

- Up to 9,000 pictures can be displayed in list by date mode. If more pictures exist, “*” is displayed next to the number.
- Pictures taken without setting date and time are not listed in this mode.

















Print Set

When print marking already exists for pictures taken on dates other than that specified, a confirmation dialog **Save print marking for other dates?** will be displayed. Select **Yes** to add the new print marking to the existing marking. Select **No** to remove the existing print marking and leave only the new marking.

Operations in the Thumbnail Display









Option	Control	Description	
Scroll the screen	 	Tap  or  to scroll the screen.	-
Increase/decrease number of picture thumbnails displayed	 	Tap  or  .	-
Create print orders		Create print orders to the pictures taken on the selected date.	113
Create an HD Pictmotion slide show		Create an HD Pictmotion slide show from pictures taken on the selected date.	82
Delete pictures		Tap  to display the delete menu. Tap  to select pictures for deletion. Tap  ALL to delete all pictures displayed as thumbnails.	-
Switch to thumbnail display in playback mode		Tap  to switch to thumbnail display in playback mode.	52
Switch to shooting mode	-	Press the shutter-release button to switch to the last shooting mode used.	-

Operations in the Full-frame Display

Option	Control	Description	
View previous or subsequent picture	 	Tap  or  or drag the current picture up or down to view previous or subsequent picture.	28
Zoom in		Zoom increases each time  is tapped, to a maximum of 10x. Tapping the picture displayed in the monitor also zooms in.	53
Display thumbnail playback		Tap  to switch to thumbnail display.	-
Edit pictures		Tap  to display the retouch menu.	54
Delete pictures		Tap  to delete the picture currently displayed.	28
Add favorite pictures		Tap  to add the picture currently displayed to the favorites folder.	75
Switch to thumbnail display in playback mode		Tap  to switch to thumbnail display in playback mode.	52
Switch to shooting mode	-	Press the shutter-release button to switch to the last shooting mode used.	-



Finding Pictures in Auto Sort Mode

Pictures and movies will automatically be sorted in any of the following folder during shooting. If  auto sort mode is selected, pictures and movies can be viewed by selecting the folder to which they were sorted with shooting.

 Smile	 Portraits	 Food
 Landscape	 Dusk to dawn	 Close-ups
 Movie	 Retouched copies	 Other scenes

All pictures sorted according to the same category can be selected for deletion and printing. In full-frame playback mode, just as with playback mode, picture display can be enlarged, pictures can be edited, voice memos can be recorded or played back, and movies can be played back.

Viewing Pictures in Auto Sort Mode

- 1 Tap  in the thumbnail display ( 52) to display the sort menu, and then tap .

A list of categories is displayed.

For detailed information about categories, see “Categories and the Contents” ( 70).

- 2 Tap the desired folder.

Pictures are displayed as thumbnails.







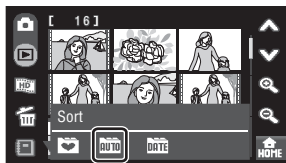

Tap the picture to display the picture full frame.

Tap  to return to the category list.

For detailed information about operations available in auto sort mode, see “Operations in Auto Sort Mode” ( 71).



Categories and the Contents

Folder	Description
 Smile	Pictures taken with the smile timer (📷 33) are displayed.
 Portraits	Pictures taken with face priority (📷 126) in 📷 (auto) mode (📷 22) or Scene auto selector scene mode (📷 43), or in Portrait* , Night Portrait* , Party/indoor or Backlight* scene mode are displayed.
 Landscape	Pictures taken in Landscape* scene mode (📷 36) are displayed.
 Dusk to dawn	Pictures taken in Night landscape* , Sunset , Dusk/dawn or Fireworks show scene mode (📷 36) are displayed.
 Close-ups	Pictures taken in Close-up* scene mode (📷 36) or with macro (📷 35) in 📷 (auto) mode are displayed.
 Food	Pictures taken in Food scene mode (📷 47) are displayed.
 Movie	Movies recorded in movie mode (📷 87) are displayed.
 Retouched copies	Pictures created using editing function (📷 54) are displayed.
 Other scenes	All pictures not included in other folders are displayed.

* The pictures taken in **Scene auto selector** scene mode (📷 43) are included.

Notes on Auto Sort Mode









- Up to 999 pictures and movie files can be added to each folder in auto sort mode. If the desired folder already contains 999 pictures, new pictures or movies cannot be added or displayed in auto sort mode. Display pictures and movies that could not be added to a folder in normal playback mode (📷 28) or list by date mode (📷 66).
- Pictures or movies copied from the internal memory or the memory card (📷 132) cannot be displayed in auto sort mode.
- Pictures or movies recorded with another make or model of camera cannot be displayed in auto sort mode.

Operations in Auto Sort Mode

The following operations are available in auto sort mode.

Operations Available with Display of Category List



















Option	Control	Description	
Create print orders		Create print orders for all pictures sorted in the selected category.	113
Create an HD Pictmotion slide show		Select a category and create an HD Pictmotion slide show.	84
Delete pictures		Delete all pictures sorted in the selected category. Tap Yes in the confirmation dialog displayed to delete.	–
View sort menu		Tap  to display the sort menu to switch to list by date mode or favorite pictures mode.	69, 78
Switch to thumbnail display in playback mode		Tap  to switch to thumbnail display in playback mode.	52
Switch to shooting mode	–	Press the shutter-release button to switch to the last shooting mode used.	–

















Print Set

When print marking already exists for pictures in categories other than that specified, a confirmation dialog **Save print marking for other images?** will be displayed. Select **Yes** to add the new print marking to the existing marking. Select **No** to remove the existing print marking and leave only the new marking.

Operations in the Thumbnail Display

Option	Control	Description	
Scroll the screen	 , 	Tap  or  to scroll the screen.	-
Increase/decrease number of picture thumbnails displayed	 , 	Tap  or  .	-
Create print orders		Create a print order of pictures in the selected category.	113
Create an HD Pictmotion slide show		Create an HD Pictmotion slide show from pictures in the selected category.	82
Delete pictures		Tap  to display the delete menu. Tap  to select pictures for deletion. Tap  to delete all pictures displayed as thumbnails.	-
Switch to thumbnail display in playback mode		Tap  to switch to thumbnail display in playback mode.	52
Switch to shooting mode	-	Press the shutter-release button to switch to the last shooting mode used.	-

Operations in the Full-frame Display

Option	Control	Description	
View previous or subsequent picture	 , 	Tap  or  or drag the current picture up or down to view previous or subsequent picture.	28
Zoom in		Zoom increases each time  is tapped, to a maximum of 10x. Tapping the picture displayed in the monitor also zooms in.	53
Display thumbnail playback		Tap  to switch to thumbnail display.	-
Edit pictures		Tap  to display the retouch menu.	54
Delete pictures		Tap  to delete the picture currently displayed.	28
Add favorite pictures		Tap  to add the picture currently displayed to the favorites folder.	75
Switch to thumbnail display in playback mode		Tap  to switch to thumbnail display in playback mode.	52
Switch to shooting mode	-	Press the shutter-release button to switch to the last shooting mode used.	-

Sorting Favorite Pictures (Favorite Pictures Mode)

Pictures can be added to the favorites folder sorted by each event such as travel or wedding. Once pictures are added to the favorites folder, only pictures in the selected folder can be played back. One picture can be added to multiple folders.

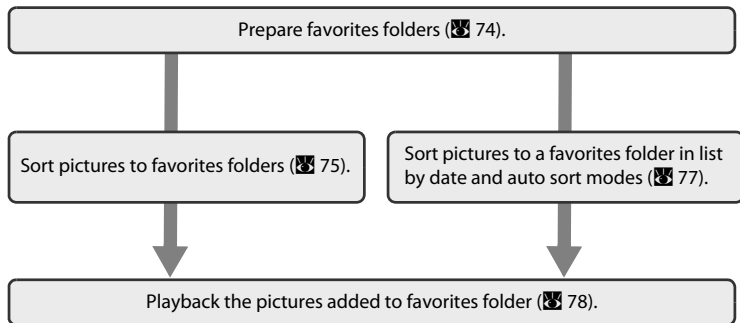

Sorting/Playback Procedure



More on Playback

Preparing Favorites Folder

Changing controls enables you to see which pictures have been added to a favorites folder. Controls can be changed again after pictures have been added to the folders.

- 1 Tap  in the thumbnail display () to display the sort menu, and then tap .

The favorites folders are displayed.

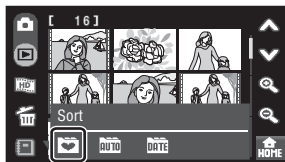

- 2 Tap .

The control selection screen is displayed.

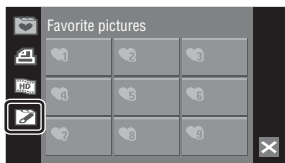

- 3 Tap the desired folder.

The screen for selecting the folder's icon and icon color is displayed.

- 4 Tap the desired control and color, and then tap **OK**.

Controls are changed and the monitor display returns to the favorite pictures screen shown in step 2.





Controls for Favorites Folder

Choose controls for favorites folders separately for the internal memory and for every memory card used. When favorite pictures stored to the internal memory, or a memory card, are played back without a control having been selected, controls are displayed as numbers (default setting). Remove the memory card from the camera to change controls for the internal memory.

Sorting Pictures to Favorites Folders

Sort pictures to a favorites folder to make it easier to find favorite pictures.

- 1 Tap  in the thumbnail display ( 52) to display the sort menu, and then tap .

The favorites folders are displayed.

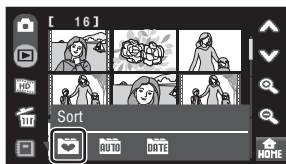

- 2 Tap the folder to which pictures will be sorted.

If a folder to which no pictures have been sorted is tapped, all pictures are displayed as thumbnails. Proceed to step 4.

If pictures have been sorted to the favorites folder, pictures in the selected favorites folder are displayed as thumbnails. Proceed to step 3.

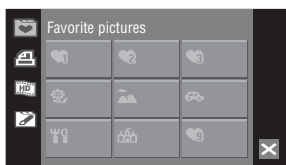

- 3 Tap .

All pictures are displayed as thumbnails.

Tap  to return to the list of favorites folder.

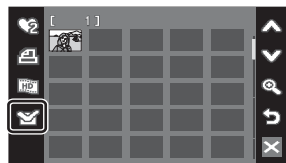

- 4 Select the desired picture.

Tap the desired picture to select (). Remove pictures from the selection by tapping them again.

If pictures already added to the favorites folder are removed from the selection, they will be removed from the favorites folder ( 78).

Up to 200 pictures can be added to each favorites folder.

Tap  to switch back to full-frame playback, and  to switch to thumbnail display.

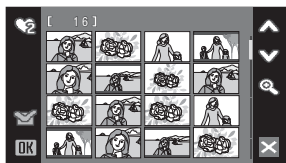

5 Tap **OK** to finalize the picture selection.



Pictures sorted to a favorites folder will be displayed as thumbnails or full frame.



Adding Favorite Picture

- One picture can be added to multiple favorites folders.
- When pictures are added to a favorites folder, they are not physically copied to a favorites folder or moved (📁 81) from the folder to which they were originally recorded (📁 151).

Sorting Pictures to a Favorites Folder in List by Date and Auto Sort Modes

- 1 Tap  in auto sort mode or full-frame playback display in list by date mode ( 68, 72).

The favorites selection screen is displayed.

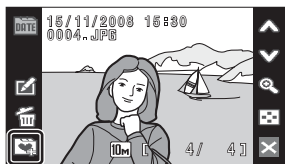

- 2 Tap the desired favorites folder to which picture are added, and tap **OK**.

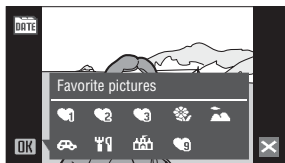

The pictures are added to the selected favorites folder.

If the selected picture has been added to a favorites folder, the check box for the favorites folder to which the picture has been added is checked ()



Viewing Pictures in Favorites Folder

Pictures can be displayed by selecting the favorites folder to which they were added in favorite pictures mode. In full-frame playback mode, just as with playback mode, picture display can be enlarged or displayed in thumbnail, pictures can be edited, or voice memos can be recorded or played back.

- 1 Tap  in the thumbnail display ( 52) to display the sort menu, and then tap .

A list of favorites folders is displayed. Pictures added to favorites folders are displayed.

For more information about sorting pictures to favorites folders, see “Sorting Pictures to Favorites Folders” ( 75).

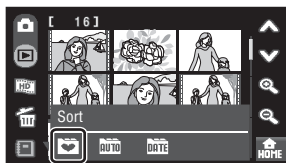

- 2 Tap the desired favorites folder to display the pictures added to that folder.

If the pictures have been added to the favorites folder, pictures in the selected favorites folder are displayed as thumbnails.



Tap the picture to display the picture full frame.

Tap  to return to the list of favorites folder.

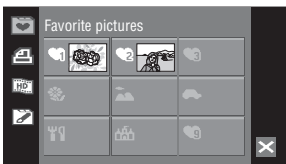
For detailed information about operations available in favorites pictures mode, see “Operations in Favorite Pictures Mode” ( 79).



Removing Pictures from Favorites

When  is tapped in the thumbnail display shown in step 2 above, the screen shown in step 4 of “Sorting Pictures to Favorites Folders” ( 75) is displayed. Tap the desired picture to deselect it (no check mark) and tap **OK** to remove the selected picture from the favorites folder.

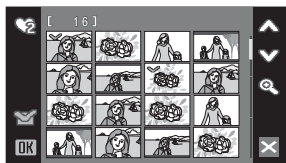





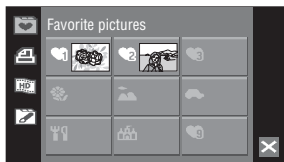

Operations in Favorite Pictures Mode

The following operations are available in favorite pictures mode.

Operations Available with Display of Favorites Folder List

















Option	Control	Description	
Create print orders		Create print orders for pictures in the selected folder.	113
Create an HD Pictmotion slide show		Select a favorites folder and create an HD Pictmotion slide show.	84
Changing controls for favorites folder		Change controls for the selected favorites folder.	74
View sort menu		Tap the desired control to display the sort menu to switch to list by date mode or auto sort mode.	66, 69
Switch to thumbnail display in playback mode		Tap  to switch to thumbnail display in playback mode.	52
Switch to shooting mode	–	Press the shutter-release button to switch to the last shooting mode used.	–

More on Playback















Print Set

When print marking already exists for pictures in folders other than that specified, a confirmation dialog **Save print marking for other images?** will be displayed. Select **Yes** to add the new print marking to the existing marking. Select **No** to remove the existing print marking and leave only the new marking.

Operations in the Thumbnail Display

Option	Control	Description	
Scroll the screen	 	Tap  or  to scroll the screen.	-
Increase/decrease number of picture thumbnails displayed	 	Tap  or  .	-
Create print orders		Create print orders for pictures in the selected folder.	113
Create an HD Pictmotion slide show		Create an HD Pictmotion slide show from the pictures in the selected folder.	82
Switch to the favorites folder editing screen		Tap  to switch to the favorites folder editing screen.	75, 78
Switch to thumbnail display in playback mode		Tap  to switch to thumbnail display in playback mode.	52
Switch to shooting mode	-	Press the shutter-release button to switch to the last shooting mode used.	-

Operations in the Full-frame Display

Option	Control	Description	
View previous or subsequent picture	 	Tap  or  or drag the current picture up or down to view previous or subsequent picture.	28
Zoom in		Zoom increases each time  is tapped, to a maximum of 10x. Tapping the picture displayed in the monitor also zooms in.	53
Display thumbnail playback		Tap  to switch to thumbnail playback.	-
Edit pictures		Tap  to display the retouch menu.	54
Switch to the favorites folder editing screen		Tap  to switch to the favorites folder editing screen.	75, 78
Switch to thumbnail display in playback mode		Tap  to switch to thumbnail display in playback mode.	52
Switch to shooting mode	-	Press the shutter-release button to switch to the last shooting mode used.	-

Adding/Viewing Favorite Pictures

When pictures are added to a favorites folder, they are not physically copied to a favorites folder or moved from the folder to which they were originally recorded (see 151). Only the file names of pictures are added to favorites folders. In favorite pictures mode, pictures with file names that have been added to the favorites folder are played back.

Adding to favorites

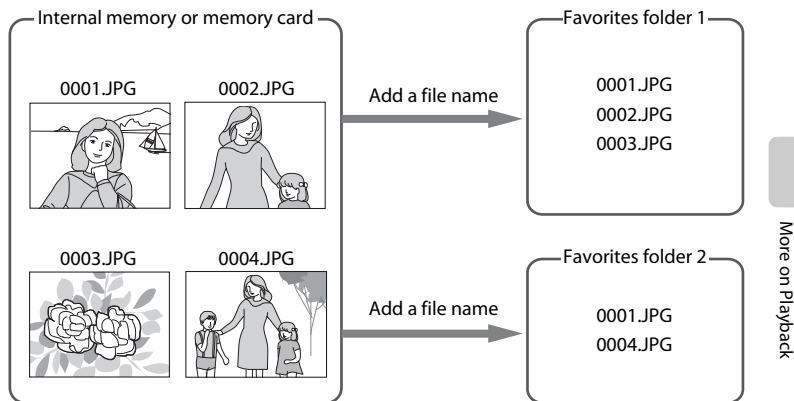

Favorite picture playback

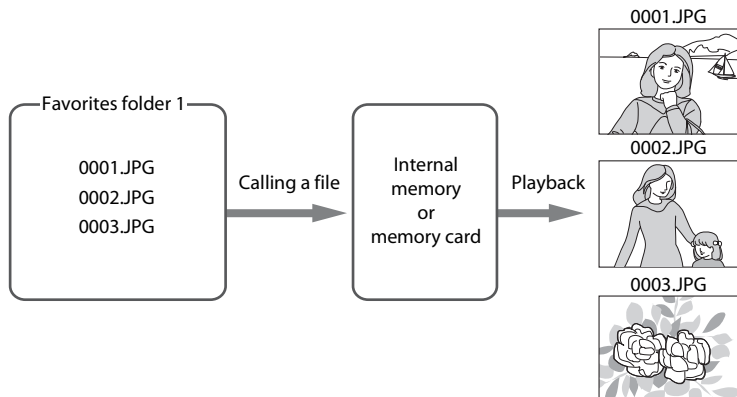

Enjoying Slide Show Using HD Pictmotion

Create an HD Pictmotion slide show that allows you to enjoy playback of selected still pictures recorded to the memory card with background music and image effects.

When the camera is connected to a TV (📺 99), HD Pictmotion slide shows can be displayed on the TV. If the camera is connected to a TV equipped with an HDMI connector, HD Pictmotion slide shows can be played back in high definition.

Creating an HD Pictmotion Slide Show

This section describes the easiest way to create an HD Pictmotion slide show.

HD Pictmotion slide shows can also be created from pictures sorted in list by date, auto sort, and favorite pictures modes (📷 84).

- 1 Tap  in the thumbnail display (📷 52).





- 2 Choose the desired pictures.

User selects pictures

Tap the desired picture to select (✔). Remove pictures from the selection by tapping them again.

Tap  or  to scroll the screen.

Tap  to increase number of picture thumbnails displayed and  to decrease number of picture thumbnails displayed.

Camera automatically selects pictures

Tap  to display the select number screen. Pictures are automatically selected according to the control tapped.

50, 100, 300, 999: Choose the selected number of the most recent pictures.

0: Cancel all selection.

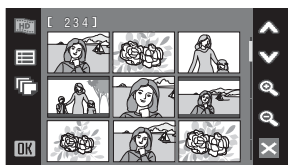

- 3** Tap **OK** to finalize the picture selection.



- 4** Tap **Create HD Pictmotion**.

After the created HD Pictmotion slide show is played back automatically, a confirmation dialog will be displayed.

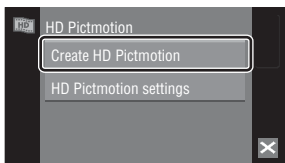

- 5** Tap **Yes**.

The HD Pictmotion slide show is saved and the monitor display returns to that shown in step 2.

For detailed information about playing back the HD Pictmotion slide show, see "Viewing an HD Pictmotion Slide Show" (86).

Settings for the saved HD Pictmotion slide show cannot be changed. If you wish to change the settings, create a new HD Pictmotion slide show with the desired settings.





✓ Notes on HD Pictmotion Slide Shows

- Only still pictures stored on the memory card can be used for HD Pictmotion slide shows. Movies and still pictures stored in the internal memory cannot be used.
- HD Pictmotion slide shows created with COOLPIX S60 cannot be played back using another model of camera.
- HD Pictmotion slide shows can be played back on this camera or on a TV to which the camera is connected, but cannot be played back on a computer to which they have been transferred.
- The current memory card holds up to 30 HD Pictmotion slide shows. If the current memory card already holds 30 HD Pictmotion slide shows, delete unnecessary movies before creating new HD Pictmotion slide shows.

Creating an HD Pictmotion Slide Show from Sorted Pictures

Select a folder in list by date, auto sort, or favorite pictures mode to use the sorted pictures, and then create an HD Pictmotion slide show.

- 1** Tap  in sort mode ( 66, 69, 78).

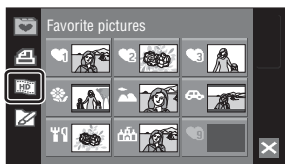

- 2** Select shooting date or category.

Tap the desired shooting date, category, or favorites folder to select (). Remove shooting dates, categories, or favorites folders from the selection by tapping them again.

Multiple shooting dates, categories, or favorites folders can be selected.

Tap **OK** to finalize the selection.

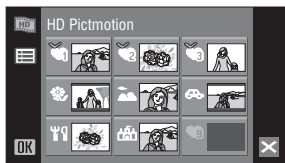

- 3** Tap **Create HD Pictmotion**.

After the created HD Pictmotion slide show is played back automatically, a confirmation dialog will be displayed.

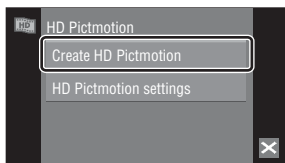

- 4** Tap **Yes**.

The HD Pictmotion slide show is saved and the monitor display returns to that shown in step 2.

Settings for the saved HD Pictmotion slide show cannot be changed. If you wish to change the settings, create a new HD Pictmotion slide show with the desired settings.

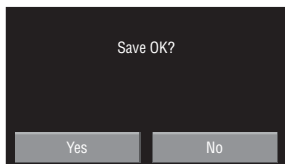

Other Options for an HD Pictmotion Slide Show

Tapping **HD Pictmotion settings** in the HD Pictmotion screen shown in step 3 of “Creating an HD Pictmotion Slide Show” (📷 83) displays the HD Pictmotion settings screen, where the options described below (① to ③) can be specified.

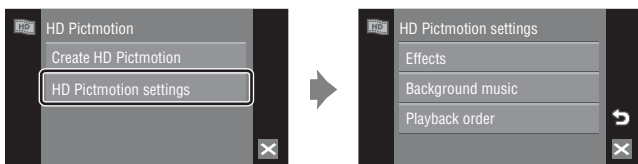

① Effects

Tap **Effects**. Choose an effect from **Classic**, **Photo album**, **Photo window**, or **Block line**.

- Tap to display a preview.



② Background Music

Tap **Background Music**. Choose background music from **Garden**, **Cube**, or **Sunset**.

- Preset tracks can be played back by tapping .

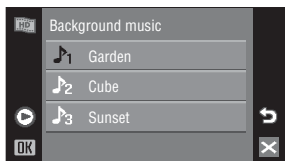

③ Playback Order

Tap **Playback Order**. Choose **Auto play**, **Random**, or **Play in order**.



Auto play: The camera selects the order in which pictures are played back depending upon the option selected for **Effects**.

Random: Pictures are played back in random order, regardless of the option selected for **Effects**.

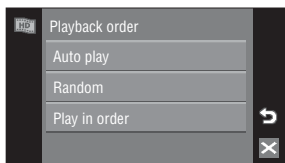
Play in order: Play pictures back in the order of their file numbers.





Viewing an HD Pictmotion Slide Show

- 1** Tap  in the thumbnail display ( 52) or sort mode ( 66, 69, 78).



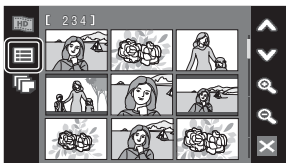





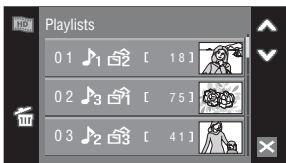

- 2** Tap .
The playlists are displayed.



- 3** Tap the desired playlist.
Playback starts.
Tap the current picture to enlarge display of that picture. Tap the picture again to resume playback. HD Pictmotion slide shows can be advanced or rewind, one frame at a time, while image display is enlarged.
Tap  to display the controller and  to hide the controller.



Tap a control displayed in the controller to perform the corresponding operation. The following operations are available.

Repeat		Tap  to play back an HD Pictmotion slide show repeatedly.
Pause		Pause playback. Tap  to resume playback.
End		Tap  to return to the playlists.
Adjust volume		Tap  during playback to display the volume menu and adjust speaker volume.

When playback ends, the monitor display returns to the playlists screen.

HD Pictmotion Slide Show Playback

COOLPIX S60 cannot play HD Pictmotion slide shows created with another model of camera.

Deleting an HD Pictmotion Slide Show

Tap  to display the delete selection screen. Tap the desired playlist to check. Tap **OK** to delete.

Recording Movies

To shoot movies with sound recorded via the built-in microphone, select shooting mode and follow the procedures below.

- 1 Tap the shooting mode control during shooting to display the shooting mode menu, and then tap .

The maximum length of the movie that can be recorded and the movie options icon are displayed in the monitor.

The movie mode can also be applied by tapping the movie mode control in the HOME screen, displayed by tapping .

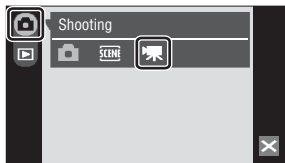

- 2 Press the shutter-release button all the way down to start recording.

Camera focuses on subject in center of frame.



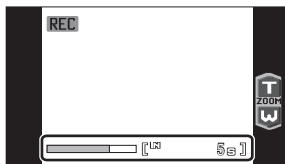

A progress bar at the bottom of the monitor shows the amount of recording time remaining.

To end recording, press the shutter-release button all the way down a second time.

Recording stops automatically when the internal memory or memory card becomes full or movie file size reaches 2 GB.



Recording Movies

- Flash mode ( 30) can only be used for time-lapse ( 91) movies. Macro mode ( 35) is available in all modes. Self-timer ( 32) cannot be used.
- Flash mode and macro mode settings cannot be applied or changed while movies are being recorded. Apply or change settings as necessary before movie recording begins.
- Optical zoom cannot be adjusted once movie recording begins. Digital zoom cannot be applied before movie recording begins. However, digital zoom (up to 2x) can be applied while movies are being recorded (except for time-lapse movie).
- In movie mode except when shooting a time-lapse movie, the angle of view (area to shoot) is smaller than that of still picture shooting mode.

Notes on Recording Movies

When the movie has been fully recorded to the internal memory or memory card, the monitor display will revert to the normal shooting mode display. **Do not open the battery-chamber/memory card slot cover** while movies are being recorded. Turning the camera off or removing the memory card while movies are being recorded could result in loss of data or in damage to the camera or card.

Changing Movie Settings

- **Movie options**, **Autofocus mode** or **Electronic VR** can be changed from the movie menu ( 88).
- When **Movie options** is set to  **Time-lapse movie** ★, movies are recorded without sound.

The Movie Menu

Movie options, **Autofocus mode** or **Electronic VR** settings can be changed from the movie menu.

Tap **HOME** in movie mode to display the HOME screen.





Tap the menu control to display the movie menu.







To exit the movie menu, tap **X**.

Selecting Movie Options

The movie menu offers the options shown below.

Option	Image size and frame rate
 TV movie 640 ★ (default setting)	Image size: 640 × 480 pixels Frame rate: 30 frames per second
 Small size 320 ★	Image size: 320 × 240 pixels Frame rate: 30 frames per second
 Small size 320	Image size: 320 × 240 pixels Frame rate: 15 frames per second
 Time-lapse movie ★ ( 91)	The camera automatically takes pictures at intervals and joins them into a silent movie. Useful when record flowers opening or butterflies emerging from cocoons. Image size: 640 × 480 pixels Frame rate: 30 frames per second

Movie Options and Maximum Movie Length and Frames

Option	Internal memory (approx. 20 MB)	Memory card (256 MB)
 TV movie 640 ★ (default setting)	19 s	3 min 40 s
 Small size 320 ★	39 s	7 min 20 s
 Small size 320	76 s	14 min 30 s
 Time-lapse movie ★ ( 91)	239 frames	1,800 frames per movie



* All figures are approximate. Maximum movie length or frames varies with make of memory card. The maximum file size for movies is 2 GB. Even if the memory card has a capacity greater than 4 GB, the camera displays the maximum movie length for the file size of 2 GB.

More Information

See "Image/Sound File and Folder Names" ( 151) for more information.

Autofocus mode

Choose how the camera focuses in movie mode.

Option	Description
 Single AF (default setting)	Camera focuses when the shutter-release button is pressed halfway and locks at this position during shooting.
 Full-time AF	Camera focuses continuously until focus is acquired and locked. To prevent sound of camera focusing from interfering with recording, use of Single AF is recommended.



Electronic VR

Enable or disable electronic VR for movie recording.

Option	Description
 On (default setting)	Reduce the effects of camera shake in all movie modes except Time-lapse movie ★ .
OFF Off	Electronic VR is not enabled.

At settings other than **Off**, the electronic VR icon is displayed in the monitor ( 9).

Vibration Reduction for Time-Lapse Movies

The vibration reduction setting when shooting a movie with the **Time-lapse movie ★** option can be applied from the **Vibration reduction** option ( 142) in the setup menu ( 133).

Time-Lapse Movies

Record flowers opening or butterflies emerging from cocoons.

- 1 Tap **Movie options** in the movie menu.

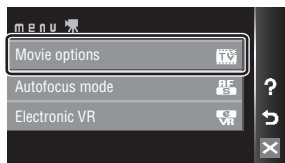

- 2 Tap  **Time-lapse movie** ★.

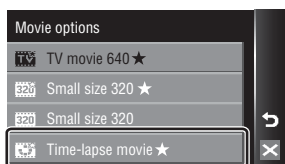

- 3 Tap the desired interval between shots.

Choose from intervals between 30 seconds and 60 minutes.

When a shot interval is tapped, the monitor display returns to the movie menu.

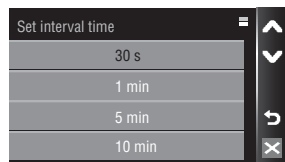

- 4 Tap .

The camera returns to shooting mode.

- 5 Press the shutter-release button all the way down to start recording.

Monitor turns off and power-on lamp blinks between shots.

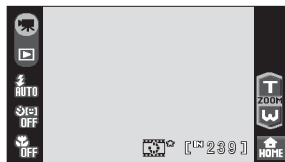

Monitor reactivates automatically for the next shot.



- 6 Press the shutter-release button all the way down a second time to end recording.

Recording will automatically stop if the internal memory or memory card becomes full, or when 1,800 frames have been recorded. A 1,800-frame movie has a playback time of 60 seconds.

Time-Lapse Movie

- Flash mode ( 30) and macro mode ( 35) cannot be adjusted after the first picture is taken. Apply the appropriate settings before shooting begins. Flash mode and macro mode settings for the second picture or later are fixed at those for the first picture.
- To prevent the camera from turning off unexpectedly during recording, use a fully charged battery.

Movie Playback

In full-frame playback mode (📷 28), movies are recognized by the movie playback guide (📷 11). To play a movie, display it in full-frame playback mode and tap the movie currently displayed.



Tap the zoom control during playback to display the volume menu, and adjust speaker volume.

Playback controls are displayed at right in the monitor. Tap a playback control to perform the corresponding operation. The following operations are available.

During playback

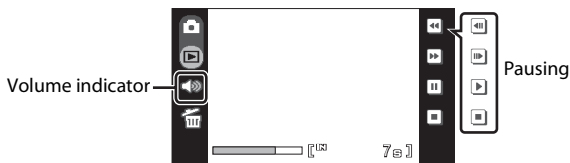

To	Control	Description	
Rewind	⏮	Touch and hold ⏮ to rewind movie.	
Advance	⏭	Touch and hold ⏭ to advance movie.	
Pause	⏸	Pause playback. The following operations can be performed while playback is paused using the controls displayed at right in the monitor.	
		⏮	Rewind movie back one frame. Touch and hold ⏮ for continuous frame-by-frame rewind.
		⏭	Advance movie forward one frame. Touch and hold ⏭ for continuous frame-by-frame advance.
	▶	Resume playback.	
End	⏹	End playback and return to full-frame playback.	

Deleting Movie Files

Tap 🗑 when playing a movie or when displayed in full-frame playback mode (📷 28). A confirmation dialog is displayed. Tap **Yes** to delete the movie, or tap **No** to exit without deleting the movie.

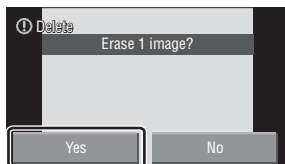

Making Voice Recordings

Audio voice recordings can be recorded over the built-in microphone and played back over the built-in speaker.

- 1 Tap the shooting mode control in shooting mode to display the shooting mode menu, and then tap **SCENE**.

The scene selection menu will be displayed. The scene selection menu can also be displayed by tapping the scene mode control in the HOME screen, displayed by tapping **HOME**.

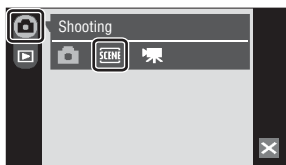

- 2 Tap **HOME**.

The voice recording screen is displayed.



- 3 Tap **Record**.

The length of recording that can be made will be displayed.



- 4 Press the shutter-release button all the way down to start recording.

REC lights during recording. If no operations are performed for about 30 seconds after voice recording begins, the camera's auto off function is enabled and the monitor turns off. Press the shutter-release button to reactivate the monitor.

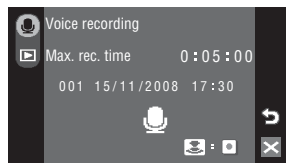

See, "Operations During Recording" (📖 95) for more information.

- 5 Press the shutter-release button all the way down a second time to end recording.

Recording will end automatically if the internal memory or memory card becomes full, or after five hours of recording on the memory card.

Tap **X** to return to the screen shown in step 3.

More Information

See "Image/Sound File and Folder Names" (📖 151) for more information.

Operations During Recording

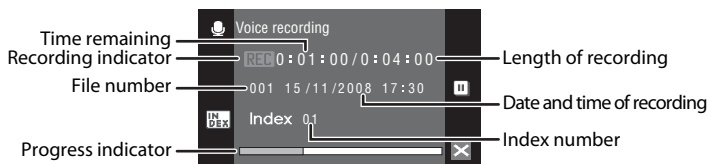

To	Control	Description
Pause/resume recording		Tap to pause recording; indicator lamp will blink. Tap to resume recording.
Create index*		During recording, tap to create index. Camera can skip to any index during playback. Start of recording is index number one; other numbers are assigned in ascending order, to a maximum of 98.
End recording	-	Press the shutter-release button to end recording.

* The copied files can be played back using QuickTime or any other WAV-compatible audio player. Note that index points created with the camera cannot be used when voice recordings are played back on computers.

Playing Voice Recordings

- 1 Tap the shooting mode control in shooting mode to display the shooting mode menu, and then tap **SCENE**.

The scene selection menu will be displayed.

The scene selection menu can also be displayed by tapping the scene mode control in the HOME screen, displayed by tapping **HOME**.

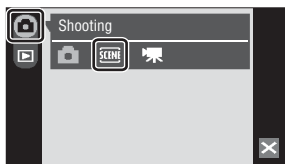

- 2 Tap .

The voice recording screen is displayed.



- 3 Tap the desired file.

The selected file will be played back.

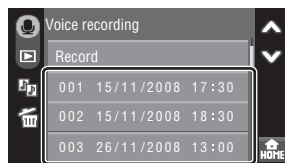

Tap  to return to the screen shown above.

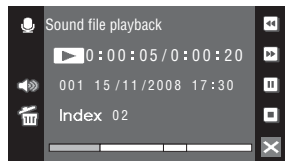

Operations During Playback

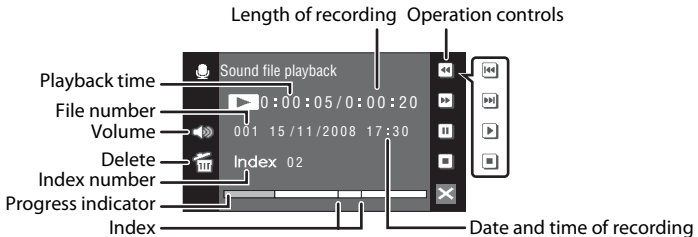

Tap the zoom control during sound file playback to display the volume menu, and adjust speaker volume.

Playback controls are displayed at right in the monitor. Tap a playback control to perform the corresponding operation. The following operations are available.

To	Control	Description	
Rewind		Rewind voice recording. Touch and hold to rewind voice recording.	
Advance		Advance voice recording. Touch and hold to advance voice recording.	
Pause		Pause playback. The following operations can be performed while playback is paused using the controls displayed at right in the monitor:	
			Skip to previous index.
			Skip to next index.
		Resume playback.	
End		End playback and return to the sound file selection screen.	

Deleting Sound Files

Tap when the sound file is being played back. A confirmation dialog will be displayed. To delete the file, tap **Yes**. To exit without deleting the sound file, tap **No**.

To delete multiple sound files, tap in the voice recording list and select the desired sound file, and then tap **OK**.

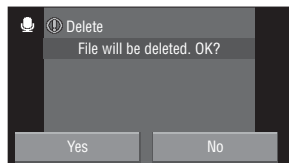



Copying Voice Recordings

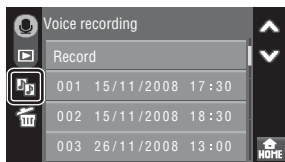

Copy voice recordings between the internal memory and a memory card. This option is available only when a memory card is inserted.

- 1** Display the voice recording screen shown in step 2 on page 96 and tap .



- 2** Tap the desired option.

 → : Copy recordings from internal memory to memory card

 → : Copy recordings from memory card to internal memory

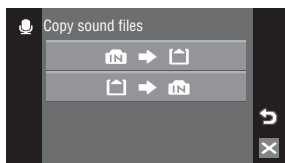

- 3** Tap the desired copy option.

Selected files: Proceed to step 4

Copy all files: Proceed to step 5

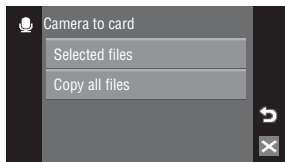

- 4** Tap the desired file.

Tap the desired file to select (). Tap the file again to cancel the selection.

Multiple files can be selected.

Tap **OK** to finalize the file selection.

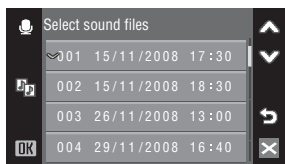

- 5** When a confirmation dialog is displayed, tap **Yes**.

Copying starts.

Tap  to return to the screen shown in step 2.

Voice Recordings

Connecting to a TV

Connect the camera to a television to play back pictures on the television. If your TV is equipped with an HDMI connector, an HDMI cable can be used to connect the camera to the TV for high-definition display of HD Pictmotion slide shows (82).

- 1 Turn off the camera.

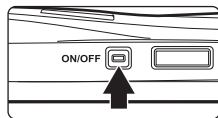

- 2 Connect the camera to the TV.

When connecting using the supplied audio/video cable

Connect the yellow plug to the video-in jack on the TV, and the white plug to the audio-in jack.

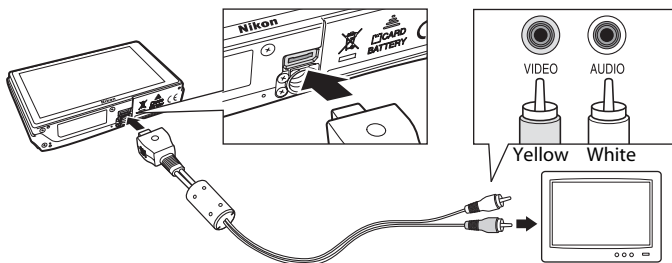

When connecting using the optional HDMI cable

Connect the plug to the HDMI jack on the TV.

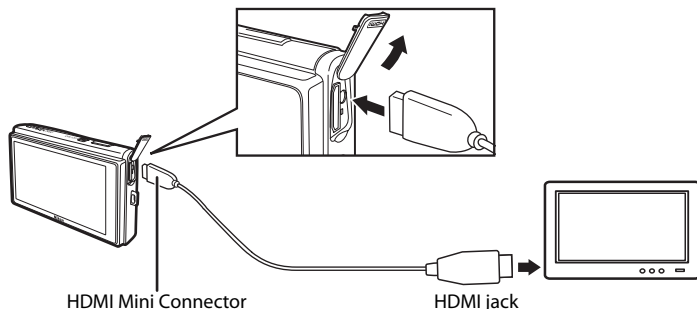

3 Adjust television settings to display input from an external device.

See the documentation provided with your television for details.

4 Turn on the camera.

Tap  to switch to playback mode.

For more information about playing back a HD Pictmotion slide show, see “Viewing an HD Pictmotion Slide Show” ( 86).

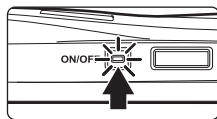

Television Display with Camera Connection

When the camera is connected to a TV, playback screens (except retouch screens) are displayed on the TV. However, when the camera is connected to a TV using an HDMI cable, the movie playback screen cannot be displayed.

When the camera is connected to a TV using the audio/video cable, shooting screens, menu screens, and voice recording screens are also displayed.



Note on Connecting an HDMI Cable

Use a third-party HDMI cable to connect the camera to a TV. The output terminal on this camera is a HDMI Mini Connector. When purchasing an HDMI cable, be sure that the device end of the cable is a HDMI Mini Connector.

Connecting the Cable

When connecting the cable, be sure that the camera connector is oriented correctly. Do not use force when connecting the cable to the camera. When disconnecting the cable, do not pull the connector at an angle.

Video Mode

Be sure that the camera's video mode setting conforms to the standard used by your television. The video mode setting is an option set in the setup menu ( 133)>**TV settings** ( 146).

Connecting to a Computer

Use the supplied USB cable to connect the camera to a computer, and copy (transfer) pictures to a computer with the supplied Nikon Transfer software.

Before Connecting the Camera

Install the Software

Before connecting the camera to a computer, software, including Nikon Transfer and Panorama Maker for creating panorama images, must be installed from the supplied Software Suite CD. For more information on installing the software, refer to the *Quick Start Guide*.

Operating Systems Compatible with the Camera

Windows

Preinstalled versions of 32-bit Windows Vista Service Pack 1 (Home Basic/Home Premium/Business/Enterprise/Ultimate editions), Windows XP Service Pack 2 (Home Edition/Professional)

Macintosh

Mac OS X (version 10.3.9, 10.4.11, 10.5.2)

Refer to the Nikon website for the latest information on operating system compatibility.

Note on Power Source

When connecting the camera to a computer or printer, use a fully charged battery to prevent the camera from turning off unexpectedly.

If You Are Using Windows 2000 Professional

- Do not connect the camera to the computer.
- Use a card reader or similar device to transfer pictures stored on the memory card to the computer (☒ 104).
- If the camera has been connected to the computer, the Found New Hardware Wizard dialog is displayed. Select **Cancel** to close the dialog and disconnect the camera from the computer.

Transferring Pictures from a Camera to a Computer

- 1 Start the computer to which Nikon Transfer was installed.
- 2 Turn off the camera.
- 3 Connect the camera to the computer using the supplied USB cable.

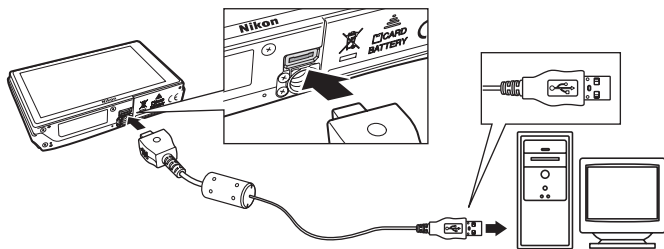

- 4 Turn on the camera.
The power-on lamp will light.

Windows Vista

When the AutoPlay dialog is displayed, click **Copy pictures to a folder on my computer using Nikon Transfer**. Nikon Transfer will start. To bypass this dialog in the future, check **Always do this for this device**.

Windows XP

When the action selection dialog is displayed, select **Nikon Transfer Copy pictures to a folder on my computer**, and click **OK**. Nikon Transfer will start. To bypass this dialog in the future, check **Always use this program for this action**.

Mac OS X

Nikon Transfer will start automatically if **Yes** was selected in the Auto-Launch setting dialog when Nikon Transfer was first installed.

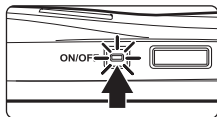

✓ Connecting the USB Cable

- When connecting the USB cable, be sure that the connectors are oriented correctly. Do not use force when connecting the USB cable. When disconnecting the USB cable, do not pull the connector at an angle.
- Connection may not be recognized when the camera is connected to a computer via a USB hub.

5 Transfer pictures when Nikon Transfer has finished loading.

Click **Start Transfer** in Nikon Transfer. At default settings, all pictures, except HD Pictmotion slide shows, are transferred to the computer.

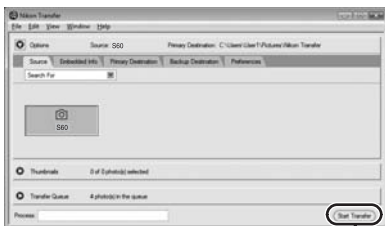

Start Transfer button

At the Nikon Transfer default setting, the folder to which pictures are transferred is automatically opened when transfer is complete.

For more information on using Nikon Transfer, refer to help information contained in Nikon Transfer.

6 Disconnect the camera when transfer is complete.

Turn the camera off and disconnect the USB cable.

Using a Card Reader

The pictures stored on the memory card inserted into a card reader or similar device can also be transferred to the computer using Nikon Transfer.

- If the memory card has a capacity greater than 2 GB, or is SDHC-compliant, the intended device must support these features of the memory card.
- At the Nikon Transfer default settings, Nikon Transfer will start automatically when a memory card is inserted into the card reader or similar device. See step 5 of “Transferring Pictures from a Camera to a Computer” (📖 103).
- To transfer pictures stored in the camera’s internal memory to the computer, the pictures must first be copied to a memory card using the camera (📖 98, 132).

Using Standard OS Operations to Open Image/Sound Files

- Navigate to the folder on the computer’s hard disk to which pictures were saved and open a picture in the viewer supplied with your operating system.
- Sound files copied to the computer can be played back using QuickTime or any other WAV-compatible audio player.

Panorama Creation with Panorama Maker

- Use a series of pictures taken using the **Panorama assist** option in scene mode (📖 50) to create a single panorama photo with Panorama Maker.
- Panorama Maker can be installed to a computer using the supplied Software Suite CD. After installation is complete, follow the procedure described below to start Panorama Maker.

Windows

Open **All Programs (Programs** under Windows 2000) from the **Start** menu>**ArcSoft Panorama Maker 4**>**Panorama Maker 4**.

Macintosh

Open Applications by selecting **Applications** from the **Go** menu, and double-click the **Panorama Maker 4** icon.

- For more information on using Panorama Maker, refer to the on-screen instructions and help information contained in Panorama Maker.

Image File Names and Folder Names

See “Image/Sound File and Folder Names” (📖 151) for more information.

Connecting to a Printer

Users of PictBridge-compatible (📷 168) printers can connect the camera directly to the printer and print pictures without using a computer.

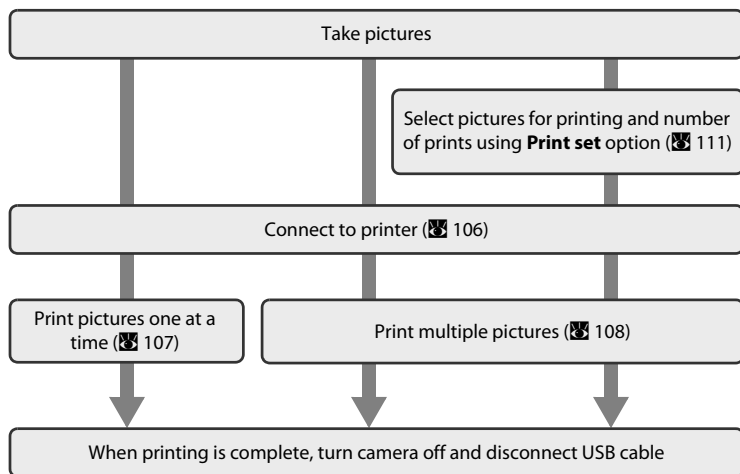

✔ **Note on Power Source**

When connecting the camera to a computer or printer, use a fully charged battery to prevent the camera from turning off unexpectedly.

📷 **Printing Pictures**

In addition to printing pictures transferred to a computer from your personal printer and printing over a direct camera-to-printer connection, the following options are also available for printing pictures:

- Insert a memory card into a DPOF-compatible printer's card slot
- Take a memory card to a digital photo lab

To print pictures using either of these methods, use your camera's **Print set** menu (📷 111) to select the pictures, and the desired number of prints each, from those recorded to a memory card.

Connecting the Camera and Printer

- 1 Turn off the camera.

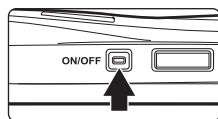

- 2 Turn on the printer.

Check printer settings.

- 3 Connect the camera to the printer using the supplied USB cable.

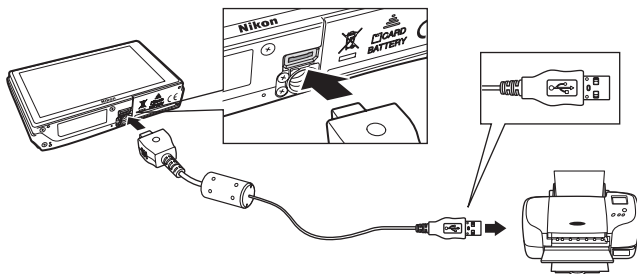

- 4 Turn on the camera.

When connected correctly, the PictBridge startup screen

① will be displayed in the camera monitor. Then the print selection screen will be displayed ②.

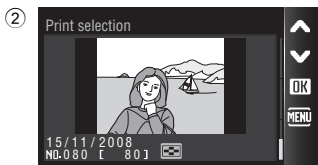
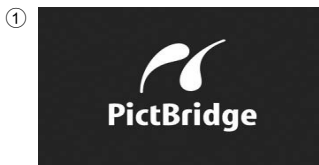
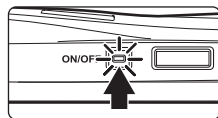



✓ Connecting the USB Cable

When connecting the USB cable, be sure that the connectors are oriented correctly. Do not use force when connecting the USB cable. When disconnecting the USB cable, do not pull the connector at an angle.

Printing Pictures One at a Time

After connecting the camera to the printer correctly (❗ 106), print pictures by following the procedures below.

- 1 Tap  or  to choose the desired picture, and tap **OK**.

Tap  to display 12 thumbnails, and  to switch back to full-frame playback.

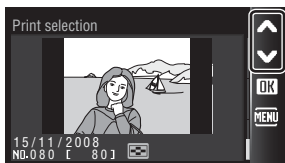

- 2 Tap **Copies**.

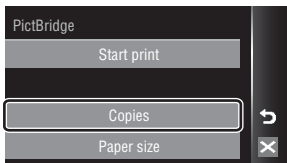

- 3 Tap the desired number of copies.

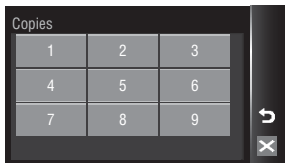

- 4 Tap **Paper size**.

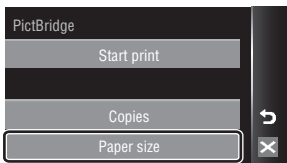

- 5 Tap the desired **Paper size**.

To specify paper size using printer settings, tap **Default** in the paper size menu.

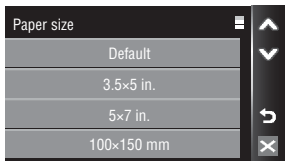

6 Tap Start print.**7 Printing starts.**

Monitor display returns to that shown in step 1 when printing is complete.

To cancel before all copies have been printed, tap .



Current print/total number of prints

Printing Multiple Pictures

After connecting the camera to the printer correctly ( 106), print pictures by following the procedures below.

1 When the print selection screen is displayed, tap .

The print menu is displayed.

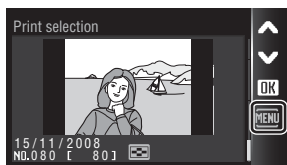
**2 Tap Paper size.**

To exit the print menu, tap .

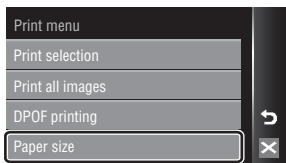
**3 Tap the desired Paper size.**

To specify paper size using printer settings, tap **Default** in the paper size menu.

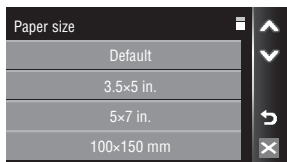

4 Tap **Print selection**, **Print all images** or **DPOF printing**.

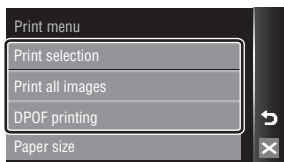

Print selection

Choose the pictures and number of copies (up to nine) of each.

Tap the desired picture to print and tap **+** or **-** to set the number of copies for each.

Pictures selected for printing can be recognized by the check mark (✓) and the numeral indicating the number of copies to be printed. A

check mark is not displayed with pictures for which no copies have been specified and these pictures will not be printed.

Tap to switch back to full-frame playback, and to display 12 thumbnails.

Tap **OK** when setting is complete.

The menu shown at right will be displayed.

To print, tap **Start print**.

Tap **Cancel** to return to the print menu.

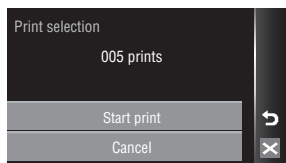
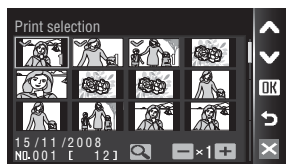

Print all images

All pictures stored in the internal memory, or on the memory card, are printed one at a time.

The menu shown at right will be displayed.

To print, tap **Start print**.

Tap **Cancel** to return to the print menu.

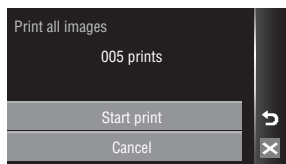

DPOF printing

Print pictures for which a print order was created in **Print set** (🗑️ 111). The menu shown at right will be displayed. To print, tap **Start print**.

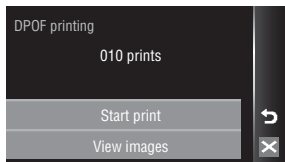

To view the current print order, tap **View images**. To print pictures, tap **OK**.

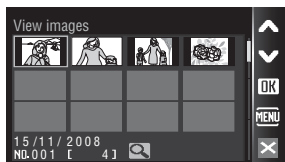

5 Printing starts.

Monitor display returns to the print menu shown in step 2 when printing is complete.

To cancel before all copies have been printed, tap 🗑️.



Current print/total number of prints

✓ Paper Size

The camera supports the following paper sizes: **Default** (the default paper size for the current printer), **3.5 × 5 in.**, **5 × 7 in.**, **100 × 150 mm**, **4 × 6 in.**, **8 × 10 in.**, **Letter**, **A3**, and **A4**. Only sizes supported by the current printer will be displayed. To specify paper size using printer settings, choose **Default** in the paper size menu.

Creating a DPOF Print Order: Print Set

The **Print set** option in the playback menu is used to create digital “print orders” for printing on DPOF-compatible devices (📷 168).

When the camera is connected to a PictBridge-compatible printer, pictures can be printed from the printer according to the DPOF print order you have created for pictures on the memory card. If the memory card is removed from the camera, you can create the DPOF print order for pictures in the internal memory and print pictures according to the DPOF print order.

- 1 Tap **HOME** in playback mode to display the HOME screen, and then tap the menu control.

The playback menu is displayed.

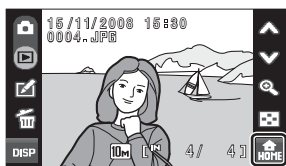

- 2 Tap **Print set**.



- 3 Tap **Select images**.

Tap **Delete print set** to delete print orders for all pictures.

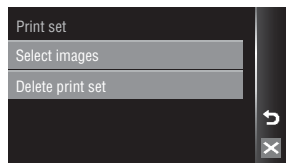

- 4 Choose the pictures (up to 999) and number of copies (up to nine) for each.

Tap the desired picture to print and tap **+** or **-** to set the number of copies for each.

Pictures selected for printing can be recognized by the check mark (✔) icon and the numeral indicating the number of copies to be printed. A check mark is not displayed with pictures for which no copies have been specified and these pictures will not be printed.

Tap **Q** to switch back to full-frame playback, and **12** to display 12 thumbnails.

Tap **OK** when setting is complete.



5 Choose whether or not to also print shooting date and photo information.

Tap **Date** to print date of recording on all pictures in the print order.

Tap **Info** to print photo information (shutter speed and aperture) on all pictures in the print order.

Tap **OK** to complete the print order and exit.

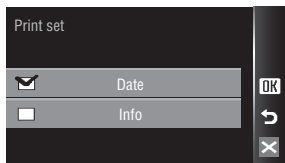

Notes on Printing Shooting with Date and Photo Information

- When the **Date** and **Info** options are enabled in the print set menu, shooting date and photo information are printed on pictures when a DPOF-compatible (168) printer which supports printing of shooting date and photo information is used.
- Photo information cannot be printed when the camera is connected directly to a printer, via the supplied USB cable, for DPOF printing (108).
- **Date** and **Info** are reset each time the print set menu is displayed.

Print Order Pictures

Pictures selected for printing are recognized by  icon displayed with playback.

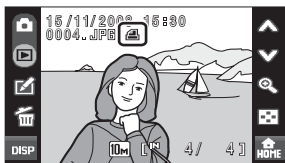

Note on the Print Set Date Option

The date and time printed on pictures with DPOF printing when **Date** in the **Print set** menu is enabled, are those recorded with the picture when it was taken. Date and time printed using this option are not affected when the camera's date and time setting are changed from the setup menu after pictures are recorded.



Date Imprint



When date and time of recording are imprinted on pictures using the **Date imprint** option (140) in the setup menu, pictures with the date and time imprinted on them can be printed from printers that do not support printing of the date and time on pictures.



Only the **Date imprint** date and time on pictures will be printed, even if **Print set** is enabled with **Date** selected in the print set screen.



Creating a Print Order in Sort Mode





Create print orders by shooting date or category.

1 Tap in sort mode.

Tap  in the date selection screen ( 67) to create a print order for all pictures taken on the selected date. Proceed to step 3.

Tap  while the auto sort category list is displayed ( 71) to create a print order for all pictures sorted to the selected category. Proceed to step 3.

Tap  while the favorites folder list is displayed ( 79) to create a print order for all pictures sorted to the selected folder. Proceed to step 3.

Tap  in the thumbnail display for each sort mode ( 68,  72,  80) to display the print set menu. Proceed to step 2.

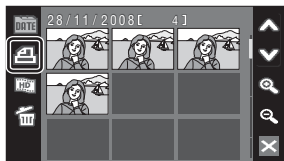
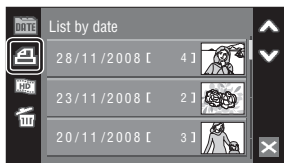



2 Tap or ALL.

Tap  to select pictures for print order.

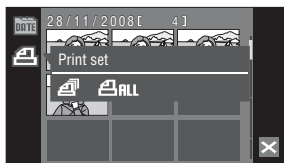
Tap  ALL to select all pictures displayed in the thumbnail list for the print order.



3 Specify a date, category, favorites folder, or pictures to be printed as well as the number of prints for each (up to nine).

Tap the desired date, category, favorites folder, or pictures to be printed, and then tap  or  to specify the number of copies for each.

If **ALL** was selected in step 2, tap  or  to specify the number of copies at the same time.

The date, category, favorites folder, or pictures selected for printing can be recognized by the check mark and numeral, indicating the number of copies to be printed, displayed with them. A check mark is not displayed with date, category, favorites folder, or pictures for which no copies have been specified and these dates, categories, favorites folders, and pictures will not be printed.

Tap **OK** once all print order settings have been applied.

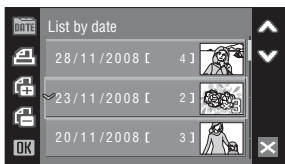

4 Choose whether or not to also print shooting date and photo information.

Tap **Date** to print date of recording on all pictures in the print order.





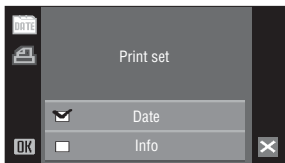

Tap **Info** to print photo information (shutter speed and aperture) on all pictures in the print order.

Tap **OK** to complete the print order and exit.



Shooting Options: The Shooting Menu

The shooting menu contains the following options.

Image mode*	 116
Choose image size and quality.	
White balance	 118
Match white balance to the light source to record pictures with colors that most closely resemble those in the actual scene.	
Exp. +/- (Exposure compensation)	 120
Alter exposure to make pictures brighter or darker.	
Continuous	 121
Change settings for Continuous or BSS (best shot selector).	
ISO sensitivity	 123
Control camera's sensitivity to light.	
AF area mode	 124
Choose where the camera focuses.	
Distortion control	 127
Correct the distortion.	

* The **Image mode** setting is also available from other shooting menus (except the movie menu).

Displaying the Shooting Menu

Tap  in shooting mode to display the HOME screen.

Tap the menu control to display the shooting menu.













To exit the shooting menu, tap .

Functions that Cannot Be Applied Simultaneously

Some functions cannot be enabled in conjunction with others ( 128).

Image Mode

Choose an image mode, which is the combination of image size and image quality (compression), according to how you plan to use the picture and the capacity of the internal memory or memory card. The larger the image, the larger the size at which it can be printed or displayed without becoming noticeably “grainy,” limiting the number of pictures that can be recorded.

Option	Size (pixels)	Description
 High (3648★)	3,648 × 2,736	Highest quality, suitable for enlargements or high-quality prints. The compression ratio is approximately 1:4.
 Normal (3648) (default setting)	3,648 × 2,736	Best choice in most situations. The compression ratio is approximately 1:8.
 Normal (2592)	2,592 × 1,944	
 Normal (2048)	2,048 × 1,536	Smaller size allows more pictures to be stored. The compression ratio is approximately 1:8.
 PC screen (1024)	1,024 × 768	Suited to display on a computer monitor. The compression ratio is approximately 1:8.
 TV screen (640)	640 × 480	Suited to full-screen display on a television, or distribution by e-mail or the web. The compression ratio is approximately 1:8.
 16:9 (3584)	3,584 × 2,016	Pictures with an aspect ratio of 16:9 can be taken.  16:9 (1920) is suited to display on high-definition televisions (HDTV) with an aspect ratio of 16:9.
 16:9 (1920)	1,920 × 1,080	 16:9 (3584) is a larger image, suited to printing at larger sizes. The compression ratio for both image sizes is approximately 1:8.









The icon for the current setting is displayed in the monitor in shooting and playback modes (, 9, 11).

Image Mode

Changes made to the image mode setting apply to all shooting modes (except those available from the movie menu).

Number of Exposures Remaining



The following table lists the approximate number of pictures that can be stored in internal memory and on a 256 MB memory card. Note that the number of pictures that can be stored will differ depending on the composition of the picture (due to JPEG compression). In addition, this number may differ depending on the make of memory card, even if the capacity for the memory card is the same.

Setting	Internal memory (approx. 20 MB)	Memory card ¹ (256 MB)	Print size ² (cm/in.)
 High (3648★)	4	50	31 × 23/12.2 × 9
 Normal (3648)	9	100	31 × 23/12.2 × 9
 Normal (2592)	17	195	22 × 16.5/8.6 × 6.4
 Normal (2048)	28	305	17 × 13/6.7 × 5.1
 PC screen (1024)	95	1045	9 × 7/3.5 × 2.7
 TV screen (640)	179	1965	5 × 4/1.9 × 1.5
 16:9 (3584)	12	135	30 × 17/11.8 × 6.6
 16:9 (1920)	41	445	16 × 9/6.3 × 3.5

¹ If the number of exposures remaining is 10,000 or more, the number of exposures remaining display shows **9999**.

² Print size at an output resolution of 300 dpi. Print sizes are calculated by dividing the number of pixels by printer resolution (dpi) and multiplying by 2.54 cm (1 in.). However, at the same image size, pictures printed at higher resolutions will print smaller than the size indicated, and those printed at lower resolutions will print larger than the size indicated.

Image Mode Setting and Monitor Display

When the **Image mode** setting of  **16:9 (3584)** or  **16:9 (1920)** is selected, the aspect ratio of the monitor in shooting and playback modes changes to 16:9.

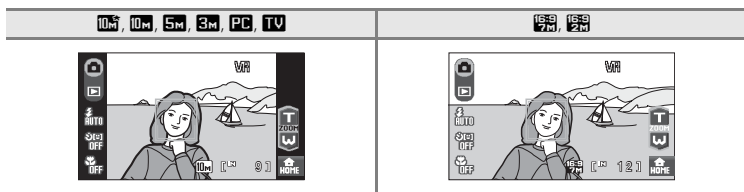

White Balance

The color of light reflected from an object varies with the color of the light source. The human brain is able to adapt to changes in the color of the light source, with the result that white objects appear white whether seen in the shade, direct sunlight, or under incandescent lighting. Digital cameras can mimic this adjustment by processing images according to the color of the light source. This is known as “white balance.” For natural coloration, choose a white balance setting that matches the light source before shooting. Although the default setting, **Auto**, can be used under most types of lighting, you can apply the white balance setting suited to a particular light source to achieve more accurate results.

Auto (default setting)

White balance automatically adjusted to suit lighting conditions. Best choice in most situations.

Preset manual

Neutral-colored object used as reference to set white balance under unusual lighting conditions. Please refer to “Preset Manual” for more information ( 119).

Daylight

White balance adjusted for direct sunlight.

Incandescent

Use under incandescent lighting.

Fluorescent

Use under most types of fluorescent lighting.

Cloudy

Use when taking pictures under overcast skies.

Flash

Use with the flash mode.

The effects of the selected option can be previewed in the monitor. At settings other than **Auto**, the icon for the current setting is displayed in the monitor ( 9).

Flash Mode

At white-balance settings other than **Auto** or **Flash**, turn the flash off (  30).

Preset Manual

Preset manual is used with mixed lighting or to compensate for light sources with a strong color cast (for example, to make pictures taken under a lamp with a red shade look as though they had been taken under white light).

- 1 Place a white or gray reference object under the lighting that will be used during shooting.

- 2 Tap **PRE Preset manual** in the white balance menu.

The camera zooms in.



- 3 Frame the reference object in the monitor.

To apply the most recently measured value for preset manual, tap **Cancel**.

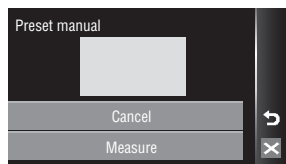

- 4 Tap **Measure** to measure a value for preset manual.

The shutter is released and the new white-balance value is set.

No pictures are recorded.

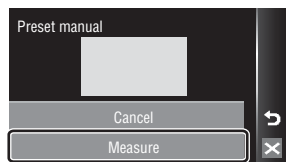

✔ Note on Preset Manual

Regardless of the flash mode selected, the flash will not fire when the camera measures a value with step 4. Therefore, the camera cannot measure a value for preset manual when the flash is used.

Exp.+/-

Exposure compensation is used to alter exposure from the value suggested by the camera to make pictures brighter or darker.

- When the subject is too dark: tap **+** to adjust the exposure compensation to “+” side.
- When the subject is too bright: tap **-** to adjust the exposure compensation to “-” side.
- Exposure compensation can be set to values between -2.0 and +2.0 EV.

At settings other than **0.0**, the indicator for the current setting is displayed in the monitor ( 9).

Exposure Compensation Value

The exposure compensation value applied in  (auto) mode is stored in the camera's memory even after the camera is turned off, and reapplied the next time  (auto) mode is selected.

The exposure compensation value is applied in any scene mode, the setting reverts to **0.0** whenever another shooting mode is selected or the camera is turned off.

Using Exposure Compensation

The camera tends to lower exposure when the frame is dominated by brightly lit objects and to increase exposure when the frame is mostly dark. Positive compensation may therefore be required to capture the brilliancy of very bright objects that fill the frame (for example, sunlit expanses of water, sand, or snow) or when the background is much brighter than the main subject. Negative compensation may be called for when large areas of the frame contain very dark objects (for example, a swath of dark green leaves) or when the background is much darker than the main subject.

Continuous

Change settings to Continuous or BSS (best shot selector). Flash will be switched off when **Continuous**, **BSS** or **Multi-shot 16** is selected. Focus, exposure and white balance are fixed at the values for the first picture in each series.

Single (default setting)

One picture is taken each time the shutter-release button is pressed.

Continuous

While the shutter-release button is held down, up to 7 pictures are taken at a rate of about 1.2 frames per second (fps) when **Image mode** is set to  **Normal (3648)**.

BSS BSS (Best Shot Selector)

BSS is recommended for shooting under low lighting without the flash, with the camera zoomed in, or in other situations in which camera shake is likely to blur pictures.

The camera takes up to ten pictures while the shutter-release button is held down. The sharpest picture (picture with the most detail) in the series is automatically selected and saved.

Multi-shot 16

Each time the shutter-release button is pressed, the camera takes 16 shots at about 1.5 frames per second and arranges them in a single picture with **Image mode** setting set to  **Normal (2592)**.

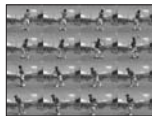

Intvl timer shooting

The camera takes pictures (up to 1,800 frames) automatically at specified interval ( 122).

At settings other than **Single**, the indicator for the current setting is displayed in the monitor ( 9).

Note on Continuous Shooting

- The maximum frame rate with continuous shooting may vary, depending upon the current image mode setting and the memory card used.
- Digital zoom is not available when **Multi-shot 16** is selected.

Note on BSS

BSS may not produce the desired results if the subject moves or the composition changes while the shutter-release button is pressed all the way down.

Interval Timer Photography

Pictures are taken automatically at specified intervals. Choose from intervals between 30 seconds and 60 minutes.

- 1 Tap **Intvl timer shooting** in the continuous menu.

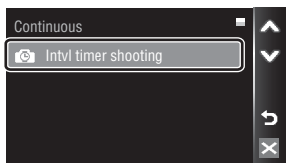

- 2 Tap the desired interval between shots.

The monitor display returns to the shooting menu.

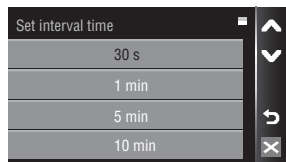

- 3 Tap **[X]**.

The camera returns to shooting mode.

- 4 Press the shutter-release button all the way down to take the first picture and initiate interval timer shooting.

Monitor turns off and power-on lamp blinks between shots.

The monitor turns on automatically right before the next shot is taken.

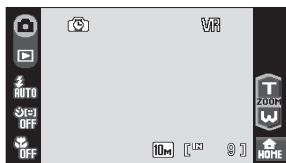

- 5 Press the shutter-release button all the way down a second time to end recording.

Recording will end automatically if the internal memory or memory card becomes full, or when 1,800 pictures have been taken.

✓ Note on Interval Timer Shooting

To prevent the camera from turning off unexpectedly during recording, use a fully charged battery.

🔍 More Information

See "Image/Sound File and Folder Names" (📄 151) for more information.

ISO Sensitivity

Sensitivity is a measure of how quickly the camera reacts to light. The higher the sensitivity, the less light needed to make an exposure. Although a high ISO rating is suited for taking pictures of subjects in action or in poor lighting, high sensitivity is often associated with “noise” - randomly spaced, brightly colored pixels concentrated in dark parts of the image.

Auto (default setting)

Sensitivity is ISO 64 under normal conditions; when lighting is poor and the flash is off, the camera compensates by raising sensitivity to a maximum of ISO 800.

High ISO sensitivity auto

ISO sensitivity is automatically adjusted within the range between 64 and 1600, depending upon the brightness of the scene.

64,100, 200, 400, 800, 1600, 2000, 3200

Sensitivity will be locked at the specified value.

At the settings other than **Auto**, the current setting is displayed in the monitor (📷 9). If **Auto** is selected and the sensitivity is raised above ISO 64, **ISO** icon will be displayed (📷 31). When **High ISO sensitivity auto** is selected, **HI ISO** is displayed.

✓ ISO 3200

- When **3200** is selected for ISO sensitivity, **Image mode** indicator is displayed in red during shooting.
- When **ISO sensitivity** is set to **3200**, **Image mode** cannot be set to **📷 High (3648★)**, **📷 Normal (3648)**, or **📷 16:9 (3584)**. At an image mode setting of **📷 High (3648★)** or **📷 Normal (3648)**, selecting **3200** for **ISO sensitivity** automatically switches the image mode setting to **📷 Normal (2592)**. At an image mode setting of **📷 16:9 (3584)**, selecting **3200** for **ISO sensitivity** automatically switches the image mode setting to **📷 16:9 (1920)**. When any option other than **3200** is selected for **ISO sensitivity**, the last image mode setting applied is restored.
- At an **ISO sensitivity** setting of **3200**, the **Multi-shot 16** (📷 121) option of the continuous shooting mode is not available. At a **Continuous** setting of **Multi-shot 16**, selecting **3200** for **ISO sensitivity** switches the **Continuous** setting to **Single**. The **Continuous** setting does not change even when **ISO sensitivity** is set to any option other than **3200**.

AF Area Mode

Use this option to determine where the camera focuses.

When digital zoom is in effect, the camera will focus on the subject in the center focus area regardless of the applied **AF area mode** option.

Face priority (default setting)

The camera automatically detects and focuses on a face looking toward the camera (Shooting with Face Priority →  126). If the camera detects multiple faces, the camera focuses on the face closest to the camera.

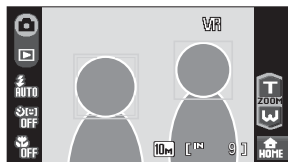

When shooting pictures of subjects other than people, or framing a subject with which no face is recognized, the camera selects the focus area (one of nine) containing the subject closest to the camera and focuses on the subject. When the shutter-release button is pressed halfway, the focus area is displayed in the monitor.

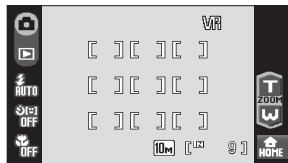

Center

Camera focuses on subject in center of frame.
Center focus area is used.

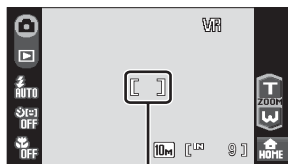

Focus area

Selecting Focus Area

The focus area can also be selected by tapping the monitor ( 24).

Focus Lock

To focus on off-center subjects when **Center** is selected for **AF area mode**, use focus lock as described below.

- 1 Position the subject in the center of the frame.
 - Confirm that the focus area is green.
 - Focus and exposure are locked.
- 2 Press the shutter-release button halfway.
 - Be sure that the distance between the camera and the subject does not change.
- 3 Continue holding down the shutter-release button halfway and recompose the picture.
 - Be sure that the distance between the camera and the subject does not change.
- 4 Press the shutter-release button the rest of the way down to shoot.



More Information

See "Autofocus" ( 27) for more information.

Shooting with Face Priority

The face-priority function is activated when **Face priority** (default setting) is selected for **AF area mode** (📷 124) or when shooting in **Scene auto selector** (📷 43), **Portrait** (📷 37), or **Night portrait** (📷 38) scene mode.

The camera automatically detects and focuses on a face looking toward the camera.

1 Frame a picture.

When the camera recognizes a face looking toward the camera, that face will be framed by a yellow double border.

When the camera detects more than one face, the closest face is framed by a double border and the others by single borders. Up to 12 faces can be detected (up to three faces when shooting with the smile timer).

The camera focuses on the face framed by the double border. To select another face for focusing, tap a face (focus area) framed by a single border. The border surrounding the selected face will change to a double border.

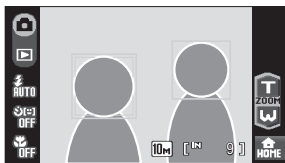

2 Press the shutter-release button halfway.

The camera focuses on the face framed by the double border. The double border will glow green and focus will be locked.

When the camera is unable to focus, the double border will blink. Press the shutter-release button halfway again and focus.

Press the shutter-release button the rest of the way down to take the picture.

When shooting with the smile timer, the shutter is automatically released if the camera detects a smiling face after the shutter-release button is fully pressed (📷 33).

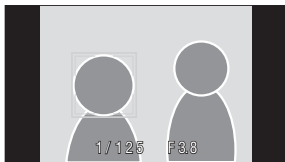

✓ Notes on Face Priority

- If no face is detected when the shutter-release button is pressed halfway in **Portrait** or **Night portrait** scene mode, the camera will focus on the subject in the center focus area.
- The camera may be unable to detect faces in the following situations:
 - When faces are partially hidden by sunglasses or other obstructions
 - When faces take up too much or too little of the frame
 - When the subject is not looking directly at the camera
- The face(s) detected, and that on which the camera focuses, depend on a variety of factors, including whether or not a particular face is looking toward the camera.
- In some rare cases shooting subjects with which autofocus may not perform as expected (🔍 27), the subject may not be in focus despite the fact that the double border glows green. Should this occur, switch to 📷 (auto) mode and shoot with the touch AF/AE function (🔍 24), or set **AF area mode** to **Center**, refocus on another subject positioned at the same distance from the camera as the actual portrait subject, and use focus lock (🔍 125).

Distortion Control

Specify whether or not the distortion is corrected. Enabling distortion control reduces the size of the frame.

On

Distortion at frame peripheries is corrected.

Off (default setting)

No distortion correction performed.

At settings other than **Off**, the icon for the current setting is displayed in the monitor (🔍 9).

Functions that Cannot Be Applied Simultaneously

Restrictions apply to the following settings in  (auto) mode.

Flash mode

Flash mode is automatically set to  (Off) and cannot be adjusted when **Continuous**, **BSS**, or **Multi-shot 16** is selected for the **Continuous** setting. Selecting **Single** or **Intvl timer shooting** for **Continuous** restores the last flash mode setting applied.









Self-timer

If self-timer is on, only one picture will be taken when the shutter is released, regardless of settings selected for the **Continuous** setting. The last **Continuous** setting applied is restored when picture is taken or self-timer is turned off.

Continuous

Image mode is automatically set to  **Normal (2592)** and cannot be adjusted when **Multi-shot 16** is selected for the **Continuous** setting. The last image mode setting applied is restored when any setting other than **Multi-shot 16** is selected for the **Continuous** setting.

ISO sensitivity

When **ISO sensitivity** is set to **3200**, **Image mode** cannot be set to  **High (3648 ★)**,  **Normal (3648)**, or  **16:9 (3584)**. At an image mode setting of  **High (3648 ★)** or  **Normal (3648)**, selecting **3200** for **ISO sensitivity** automatically switches the image mode setting to  **Normal (2592)**. At an image mode setting of  **16:9 (3584)**, selecting **3200** for **ISO sensitivity** automatically switches the image mode setting to  **16:9 (1920)**. When any option other than **3200** is selected for **ISO sensitivity**, the last image mode setting applied is restored.





At an **ISO sensitivity** setting of **3200**, the **Multi-shot 16** option of the continuous shooting mode is not available. At a **Continuous** setting of **Multi-shot 16**, selecting **3200** for **ISO sensitivity** switches the **Continuous** setting to **Single**. The **Continuous** setting does not change even when **ISO sensitivity** is set to options other than **3200**.

Distortion control

When **Distortion control** is set to **On**, the **Continuous** setting is automatically set to **Single**. Even when the **Distortion control** option is disabled, the **Continuous** setting does not change.

Playback Options: The Playback Menu

The playback menu contains the following options.

Print set	 111
Select pictures to print and the number of copies for each.	
Delete	 130
Delete all or selected pictures.	
Protect	 131
Protect selected pictures from accidental deletion.	
Rotate image	 131
Change the orientation of a picture.	
Copy	 132
Copy files between memory card and internal memory.	

Displaying the Playback Menu

Tap  in playback mode to display the HOME screen.

Tap the menu control to display the playback menu.



To exit the playback menu, tap .

Selecting Pictures

The picture selection screen, as shown at right, will be displayed with the following menus:

- **Playback menu:** **Print set** (🔒 111), **Delete>Erase selected images** (🗑️ 130), **Protect** (🔒 131), **Rotate image** (🔄 131), **Copy>Selected images** (📄 132)
- **Setup menu:** **Welcome screen** (🗑️ 135)

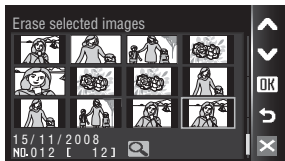

Follow the procedure described below to select pictures.

- 1 Tap the desired picture to select and tap again to deselect.

Only one picture can be selected for **Rotate image** and **Welcome screen**.

Tap to switch back to full-frame playback, and to display 12 thumbnails.

When picture is selected, a check mark (✓) is displayed in the top left corner of the current picture.

When selecting pictures for **Print set**, tap **+** or **-** to set the number of copies for each.

- 2 Tap **OK** to finalize picture selection.



Delete

Delete selected pictures or all pictures.

Erase selected images

Delete selected pictures (🗑️ 130).

Erase all images

Delete all pictures.

🗑️ Notes on Deletion

- Once deleted, pictures cannot be recovered. Transfer important images to a computer before deletion.
- Pictures marked with are protected and cannot be deleted.

Protect

Protect selected pictures from accidental deletion.

Choose pictures in the picture selection screen to apply the protect option (Selecting Pictures →  130).

Note, however, that formatting the camera's internal memory or the memory card will permanently erase protected files ( 145).



Protected pictures are recognized by  icon ( 10) in playback mode.

Rotate Image

Set the picture orientation (vertical or horizontal frame) played back in the camera monitor after pictures are taken.

Still pictures can be rotated 90° clockwise or counterclockwise. Pictures that were recorded in the portrait (vertical) orientation can be rotated up to 180° in either direction.

Select a picture in the picture selection screen ( 130), and tap **OK** to display the **Rotate image** screen.

Tap  or  to rotate the picture 90°.

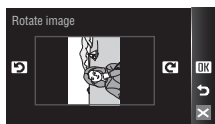

Rotate 90°
counterclockwise





Rotate 90°
clockwise



Tap **OK** to set the orientation displayed, and save the orientation data with the picture.

Copy

Copy pictures between the internal memory and a memory card.

1 Tap an option from the copy screen.

  : Copy pictures from internal memory to memory card.

  : Copy pictures from memory card to internal memory.







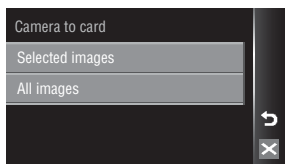

2 Tap a copy option.

Selected images: Copy pictures selected from the picture selection screen ( 130).

All images: Copy all pictures.



Notes on Copying Pictures

- JPEG-, AVI-, and WAV-format files can be copied. Files recorded in any other format cannot be copied.
- If voice memos ( 64) are attached to pictures selected for copying, voice memos are copied with the pictures.
- Sound files recorded in voice recording mode ( 94) can be copied using the **Copy sound files** option ( 98) in sound file playback mode.
- Pictures taken with another make of camera or that have been modified on a computer cannot be copied.
- Copied pictures have the same protection marking ( 131) as the original, but are not marked for printing ( 111).
- Pictures copied from the internal memory or a memory card cannot be displayed in auto sort mode ( 69).
- Even if a picture added to favorites folder ( 73) is copied, the contents of the favorites folder will not be copied.

Memory contains no images. Message



















If there are no pictures stored on the memory card when playback mode is applied, the message **Memory contains no images.** will be displayed. Switch to the HOME screen to display the playback menu. Select **Copy** from the playback menu to copy pictures stored in the camera's internal memory to the memory card.

More Information

See "Image/Sound File and Folder Names" ( 151) for more information.

Basic Camera Setup: The Setup Menu

The setup menu contains the following options.

Choose HOME display	 134
Choose a design for the HOME screen.	
Welcome screen	 135
Select screen displayed when camera is turned on.	
Date	 136
Set camera clock and choose home and destination time zones.	
Monitor settings	 139
Adjust monitor brightness and choose display style.	
Date imprint	 140
Imprint shooting date and time or date counter on pictures.	
Vibration reduction	 142
Choose whether or not vibration reduction is enabled.	
AF assist	 142
Enable or disable AF-assist illumination.	
Digital zoom	 143
Adjust settings for using digital zoom.	
Sound settings	 143
Adjust sound and volume settings.	
Record orientation	 144
Choose whether or not to record the orientation of a picture taken.	
Auto off	 144
Set time before camera enters standby mode.	
Format memory/Format card	 145
Format internal memory or memory card.	
Language	 146
Choose the language used for camera monitor display.	
TV settings	 146
Adjust settings necessary for connection to television.	
Blink warning	 146
Set whether or not to detect human subjects with eyes closed when shooting with the face priority ( 126).	
Reset all	 147
Restore camera settings to default values.	
Firmware version	 149
Display camera firmware version.	

Displaying the Setup Menu

Tap  in shooting or playback mode to display the HOME screen.

Tap the setup control to display the setup menu.



To exit the setup menu, tap .

Choose HOME Display

Choose the HOME screen display design from **Metallic** (default setting), **Burgundy**, or **Lights**.



Metallic



Burgundy



Lights

Welcome Screen

You can select the welcome screen to be displayed when the camera is turned on.

None (default setting)

Welcome screen is not displayed.

COOLPIX

Displays a welcome screen.

Select an image

Select a picture in the internal memory or on the memory card for the welcome screen. Choose a picture in the picture selection screen and tap **OK**.

As the selected image is stored in the camera, the image will appear in the welcome screen even if the original picture is deleted.

Pictures taken at an image mode setting (📷 116) of **16:9 (3584)** or **16:9 (1920)**, and copies created at a size of 320 × 240 or smaller using the crop (📷 57) or small picture (📷 63) function, cannot be used.

Date

Set the camera clock and choose home and travel destination time zones.

Date

Set camera clock to current date and time.

See step 5 and 6 of the section, "Setting Display Language, Date and Time" (📖 19) for more information.

Time zone

🏠 (home time zone) can be specified and daylight saving enabled or disabled from **Time zone** options. When ➔ (**Travel destination**) is selected, the time difference (📖 138) is automatically calculated and the date and time in the selected region are recorded. Useful when travelling.

Setting Travel Destination Time Zone

1 Tap **Time zone**.

The time zone menu is displayed.





2 Tap ➔ **Travel destination**.

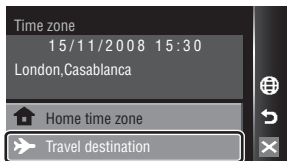



The date and time displayed on the monitor changes according to the region currently selected.

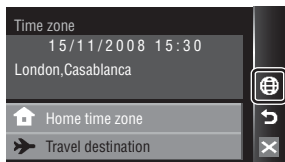

3 Tap .

The travel destination menu is displayed.

**4** Tap  or  to choose the travel destination time zone and tap **OK**.

If daylight saving time is in effect, tap . The daylight saving time option is enabled and the camera clock is advanced one hour. Tapping  toggles the daylight saving time option on (: yellow) and off (: white).

While the travel destination time zone is selected,  icon will be displayed in the monitor when the camera is in shooting mode.

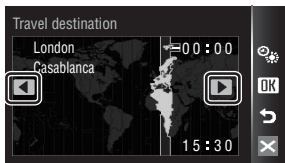
** The Clock Battery**

The clock battery charges when the main battery is installed or an AC adapter is connected, and can provide several days of backup power after about ten hours of charging.

  (Home Time Zone)

- To switch to the home time zone, choose  **Home time zone** in step 2.
- To change the home time zone, choose  **Home time zone** in step 2, and follow steps 3 and 4 for setting a travel destination time zone.

 Daylight Saving Time

When daylight saving time starts or ends, turn the daylight saving time option on or off from the time zone selection screen displayed in step 4.

Basic Camera Setup: The Setup Menu

Time Zones 18

The camera supports the time zones listed below. For time differences not listed below, set the camera clock to local time.

UTC +/-	Location	UTC +/-	Location
-11	Midway, Samoa	+1	Madrid, Paris, Berlin
-10	Hawaii, Tahiti	+2	Athens, Helsinki, Ankara
-9	Alaska, Anchorage	+3	Moscow, Nairobi, Riyadh, Kuwait, Manama
-8	PST (PDT): Los Angeles, Seattle, Vancouver	+4	Abu Dhabi, Dubai
-7	MST (MDT): Denver, Phoenix, La Paz	+5	Islamabad, Karachi
-6	CST (CDT): Chicago, Houston, Mexico City	+5.5	New Delhi
-5	EST (EDT): New York, Toronto, Lima	+6	Colombo, Dhaka
-4	Caracas, Manaus	+7	Bangkok, Jakarta
-3	Buenos Aires, Sao Paulo	+8	Beijing, Hong Kong, Singapore
-2	Fernando de Noronha	+9	Tokyo, Seoul
-1	Azores	+10	Sydney, Guam
±0	London, Casablanca	+11	New Caledonia
		+12	Auckland, Fiji

Monitor Settings

Choose whether or not to display information in the monitor, and set the monitor brightness.

Photo info

Choose information displayed in the monitor during shooting.



Brightness

Choose from five settings for monitor brightness. The default setting is **3**.

Photo Info

The following display options are available during shooting.

See “Shooting (Operation Controls)” (📷 8) for information on controls in the monitor during shooting.

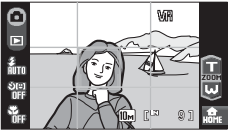
Show info	
Auto info (default setting)	<p>After the same information as in Show info above is displayed for a few seconds, display will be the same as Hide info.</p>
Hide info	
Framing grid	 <p>In 📷 (auto) mode, a framing grid is displayed to help frame pictures; other current settings or operation guide is displayed for a few seconds, as in Auto info above. In other shooting modes, the current settings or operation guide is displayed, as in Auto info above.</p>

Date Imprint

Date and time of recording can be imprinted on pictures. This information can be printed even from printers that do not support printing of date and time (📷 112).

Off (default setting)

Date and time are not imprinted on pictures.

Date

Date is imprinted on the bottom right corner of pictures taken while this option is in effect.

Date and time

Date and time are imprinted on the bottom right corner of pictures taken while this option is in effect.

Date counter

Time stamp shows number of days between date of recording and selected date (📷 141).

At settings other than **Off**, the icon for the current setting is displayed in the monitor (📷 9).

✓ Date Imprint

- Imprinted dates form a permanent part of image data and cannot be deleted.
- Dates imprinted at an **Image mode** setting (📷 116) of **TV TV screen (640)** may be difficult to read. Choose **PC PC screen (1024)** or larger when using date imprint.
- The date is recorded using the format selected in the setup menu's **Date** item (📷 18, 136).
- The date is not imprinted in the following situations:
 - pictures taken in **Sports** (📷 38), **Museum** (📷 41), or **Panorama assist** (📷 42) scene mode
 - pictures taken with **Continuous** or **BSS** selected for the **Continuous** setting in the shooting menu (📷 121)
 - movies (📷 87)

📎 Date Imprint and Print Set

When printing from DPOF-compatible printers which support printing of shooting date and photo information, the date and information can be printed on pictures without date and time imprinted on them, using options in the **Print set** menu (📷 111).

Date Counter

Pictures taken while this option is in effect are imprinted with the number of days remaining until, or the number of days elapsed since a specified date. Use it to track the growth of a child or count down the days until a birthday or wedding.

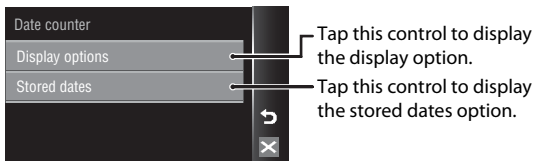

Display options

Tap **Number of days**, **Years and days**, or **Yrs, mnths, days**.

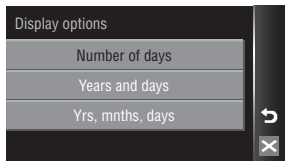

Stored dates

Up to three dates can be stored. To set, tap an option, tap \odot , enter a **Date** (\times 19, step 6 and 7), and tap **OK**. To select a different date, tap an option and tap **OK**.



Sample date counter time stamps are shown below.



Two days remaining



Two days elapsed

Vibration Reduction

Vibration reduction effectively corrects blur, caused by slight hand movement known as camera shake, that commonly occurs when shooting with zoom applied or at slow shutter speeds.

Set **Vibration reduction** to **Off** when using a tripod to stabilize the camera during shooting.

When vibration reduction is enabled, the current setting is displayed during shooting (when **Off** is selected, an icon for the current setting is not displayed) (📷 9, 23).

On (default setting)

Vibration reduction is enabled when taking pictures and recording movies. Camera detects and factors out panning movements when reducing camera shake. When camera is panned horizontally, for example, vibration reduction reduces only vertical shake. If camera is panned vertically, vibration reduction affects only horizontal shake.

Off

Vibration reduction is not enabled.

👍 Notes on Vibration Reduction

- Vibration reduction may take a few seconds to activate after the power is turned on, or the camera enters shooting mode from playback mode. Wait until the display stabilizes before shooting.
- Due to characteristics of the vibration reduction function, images displayed in the camera's monitor immediately after shooting may appear blurry.
- Vibration reduction may be unable to completely eliminate the effects of camera shake in some situations.
- **VR** stands for vibration reduction.

📷 Using Electronic VR with Movies

To reduce the effects of camera shake when recording movies other than time-lapse movies, enable **Electronic VR** (📷 90) from the movie menu (📷 88).

AF Assist

Enable or disable AF-assist illumination.

Auto (default setting)

AF-assist illumination will be used to assist the focus operation when the subject is poorly lit. The illuminator has a range of about 2.5 m (8 ft. 2.2 in.) at the maximum wide-angle position and 1.8 m (5 ft. 10.7 in.) at the maximum telescopic position. Note that for some scene modes, AF-assist illumination turns off automatically (📷 37).



Off

Disable this function. The camera may be unable to focus if lighting is poor.

Digital Zoom

Enable or disable digital zoom.

On (default setting)

When the camera is zoomed in to the maximum optical zoom position, tapping  triggers digital zoom ( 25).

Off

Digital zoom will not be activated (except when shooting a movie).

Notes on Digital Zoom

- **AF area mode** ( 124) is set to **Center** when digital zoom is in effect.
- Digital zoom cannot be used in the following situations.
 - When **Scene auto selector**, **Portrait**, or **Night portrait** is selected in scene mode
 - When shooting with the smile timer
 - When **Multi-shot 16** is selected for the **Continuous** setting
 - Before movie recording begins (however, digital zoom of up to 2x can be applied while movies, other than time-lapse movies, are being recorded)

Sound Settings

Adjust the following sound settings.

Button sound

Turn button sound **On** (default setting) or **Off**. When **On** (default setting) is selected, beep will sound once when operations are completed successfully, twice when the camera acquires focus on the subject, and three times when error is detected. Start-up sound will also play when the camera is turned on.

Shutter sound

Choose shutter sound from **On** (default setting) or **Off**.

Record Orientation

Choose whether or not camera orientation is recorded with shooting.

Auto (default setting)

Camera orientation information is recorded when shooting. Pictures will be automatically rotated in playback mode.

The following three orientations are recorded:



Landscape (wide) orientation



Camera rotated 90° clockwise



Camera rotated 90° counterclockwise

Off

Camera orientation is not recorded. With playback, pictures are always displayed in "wide" (landscape) orientation.

Picture orientation information can be modified from the **Rotate image** option in the playback menu (📷 131).

👍 Notes on Record Orientation

- When shooting with the shutter-release button held down, camera orientation information is fixed at that of the first picture in each burst, and the same orientation information is recorded with all pictures in the burst.
- When pictures are taken with the lens pointing up or down, camera orientation information may not be accurately recorded.
- When the camera is rotated during playback, the picture displayed is also rotated (📷 11).

Auto Off

If no operations are performed for the selected length of time, the monitor will turn off and the camera enters standby mode (📷 17) to reduce drain on the batteries. The power-on lamp blinks in standby mode. If no operations are performed for another three minutes, the camera will turn off automatically. Choose the time allowed to elapse before the camera enters standby mode if no operations are performed from **30 s**, **1 min** (default setting), **5 min**, and **30 min**.

👍 Notes on Auto Off

Regardless of the option selected, the monitor will remain on as follows.

- When menus are displayed: three minutes
- During HD Pictmotion slide show playback: up to 30 minutes
- When no smiling face is detected while shooting with the smile timer: five minutes (30 minutes when **Auto off** is set to **30 min**)
- When the AC adapter is connected: 30 minutes (auto off does not function while the camera is connected to a TV)

Format Memory/Format Card

Use this option to format the internal memory or a memory card.

Formatting the Internal Memory

To format the internal memory, remove the memory card from the camera.

The **Format memory** option appears in the setup menu.

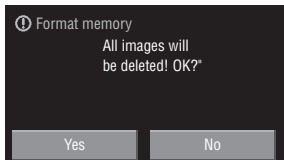

Formatting a Memory Card

When the memory card is inserted in the camera, the **Format card** option appears in the setup menu.

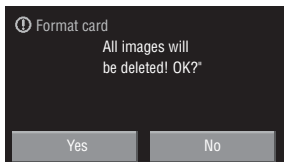

✓ Formatting Internal Memory and Memory Cards

- Formatting the internal memory or memory cards permanently deletes all data. Be sure to transfer important pictures to a computer before formatting.
- Formatting the internal memory or memory card restores favorites folder control settings (🔑 74) to the default setting (displayed as number).
- Do not turn the camera off, disconnect the AC adapter, or open the battery-chamber/memory card slot cover during formatting.
- The first time you insert the memory cards used in other devices into the COOLPIX S60, be sure to format them using this camera.

Language

Choose one of 24 languages for display of camera menus and messages.

Čeština	Czech	Polski	Polish
Dansk	Danish	Português	Portuguese
Deutsch	German	Русский	Russian
English	(default setting)	Suomi	Finnish
Español	Spanish	Svenska	Swedish
Ελληνικά	Greek	Türkçe	Turkish
Français	French	عربي	Arabic
Indonesia	Indonesian	中文简体	Simplified Chinese
Italiano	Italian	中文繁體	Traditional Chinese
Magyar	Hungarian	日本語	Japanese
Nederlands	Dutch	한글	Korean
Norsk	Norwegian	ภาษาไทย	Thai

TV Settings

Adjust settings for connection to a television.

Video mode

Choose from **NTSC** and **PAL**.

HDMI

Choose a picture resolution for HDMI output from **Auto** (default setting), **480p**, **720p**, or **1080i**. Choose the option best suited to the high-definition TV to which the camera will be connected.

Blink Warning

Set whether or not to detect human subjects with eyes closed when shooting with the face priority ( 126).

On (default setting)

When the camera detects that one or more human subjects may have closed eyes shortly after recognizing the faces and shooting them, the blink warning screen will appear in the monitor.

The face of a portrait subject, whose eyes may have been closed when the shutter was released, is framed by a yellow border. Should this occur, check the picture and decide whether or not another picture should be taken.

Off

Blink warning is not enabled.

Operating the Blink Warning Screen

When the camera detects any human subjects with closed eyes, the blink warning screen is displayed and then, the screen shown at right will appear.

The following operations are available in the blink warning screen.

If no operations are performed for a few seconds, the camera automatically returns to shooting mode.



Option	Control	Description
Enlarge the detected face		Tap . If the camera detects more than one human subjects with their eyes closed, tap or during the enlarged display to enlarge other faces.
Switch to full-frame playback		Tap .
Delete pictures		Tap .
Switch to shooting mode		Tap the monitor or tap . The shutter-release button can also be pressed to return to shooting mode.

Reset All

When **Reset** is selected, the camera's settings will be restored to their default values.

Pop-up Menu

Option	Default value
Flash mode (30)	Auto
Self-timer (32)	Off
Macro mode (35)	Off

Scene Mode

Option	Default value
White balance in Food mode (47)	Center

Movie Menu

Option	Default value
Movie options (📷 88)	TV movie 640★
Time-lapse movie★ (📷 91)	30 s
Autofocus mode (📷 90)	Single AF
Electronic VR (📷 90)	On

Shooting Menu

Option	Default value
Image mode (📷 116)	 Normal (3648)
White balance (📷 118)	Auto
Exp.+/- (📷 120)	0.0
Continuous (📷 121)	Single
Intvl timer shooting (📷 122)	30 s
ISO sensitivity (📷 123)	Auto
AF area mode (📷 124)	Face priority
Distortion control (📷 127)	Off

Setup Menu

Option	Default value
Choose HOME display (📷 134)	Metallic
Welcome screen (📷 135)	None
Photo info (📷 139)	Auto info
Brightness (📷 139)	3
Date imprint (📷 140)	Off
Vibration reduction (📷 142)	On
AF assist (📷 142)	Auto
Digital zoom (📷 143)	On
Button sound (📷 143)	On
Shutter sound (📷 143)	On
Record orientation (📷 144)	Auto
Auto off (📷 144)	1 min
HDMI (📷 146)	Auto
Blink warning (📷 146)	On

Others

Option	Default value
Paper size (📄 107, 108)	Default

- Choosing **Reset all** also clears the current file number (📄 151) from the memory. Numbering will continue from the lowest number available. To reset file numbering to “0001”, delete all pictures (📄 130) before selecting **Reset all**.
- The following menu settings will remain unaffected when menus are reset with **Reset all**.

Shooting menu: Preset manual data (📄 119) acquired for **White balance**

Setup menu: Picture selected for **Welcome screen** (📄 135), **Date** (📄 136),

Date counter (📄 141), **Language** (📄 146), and **Video mode** (📄 146)

Firmware Version

View the current camera firmware version.



Firmware version

Optional Accessories

Rechargeable battery	Rechargeable Li-ion Battery EN-EL10
Battery charger	Battery Charger MH-63
AC adapter	AC Adapter EH-63
USB cable	USB Cable UC-E13
A/V Cable	Audio/Video Cable EG-CP15

Approved Memory Cards

The following Secure Digital (SD) memory cards have been tested and approved for use in this camera. All cards of the designated make and capacity can be used, regardless of speed.

SanDisk	128 MB, 256 MB, 512 MB, 1 GB, 2 GB ¹ , 4 GB ² , 8 GB ²
TOSHIBA	128 MB, 256 MB, 512 MB, 1 GB, 2 GB ¹ , 4 GB ² , 8 GB ²
Panasonic	128 MB, 256 MB, 512 MB, 1 GB, 2 GB ¹ , 4 GB ² , 8 GB ²

¹ If the memory card will be used with a card reader or similar device, check that device supports 2 GB cards.

²  SDHC-compliant. If the memory card will be used with a card reader or similar device, check that device supports SDHC.

Operation is not guaranteed with other makes of card. Contact the manufacturer for details on the above cards.

Image/Sound File and Folder Names

Pictures, movies, voice memos and voice recordings are assigned file names as follows.

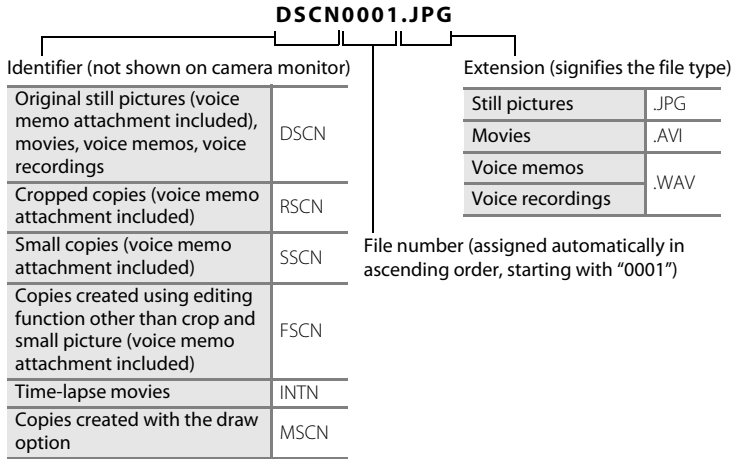

- Files are stored in folders named with a folder number followed by a five-character identifier: "P_" plus a three-digit sequence number for pictures taken using panorama assist (e.g. "101P_001"; 50), "INTVL" for interval timer photography (e.g. "101INTVL"; 122), "SOUND" for voice recordings (e.g. "101SOUND"; 94), and "NIKON" for all other pictures (e.g. "100NIKON"). When the number of files within a folder reaches 9999, a new folder will be created. File numbers will be assigned automatically starting with "0001."
- Files copied using **Copy>Selected images** or **Copy sound files>Selected files** are copied to the current folder, where they are assigned new file numbers in ascending order starting from the largest file number in memory. **Copy>All images** and **Copy sound files>Copy all files** copy all folders from the source medium; file names do not change but new folder numbers are assigned in ascending order, starting from the largest folder number on the destination medium (98, 132).
- A single folder can hold up to 200 pictures; if the current folder already contains 200 pictures, a new folder, named by adding one to the current folder name, will be created the next time a picture is taken. If the current folder is numbered 999 and contains 200 pictures, or a picture is numbered 9999, no further pictures can be taken until the internal memory or memory card is formatted (145), or a new memory card is inserted.

Caring for the Camera

To ensure continued enjoyment of this Nikon product, observe the following precautions when using or storing the device:

Keep Dry

The device will be damaged if immersed in water or subjected to high humidity.

Do not Drop

The product may malfunction if subjected to strong shock or vibration.

Handle the Lens and All Moving Parts with Care

Do not apply force to the lens, lens cover, monitor, memory card slot or battery chamber. These parts are easily damaged. Applying force to the lens cover could result in camera malfunction or damage to the lens. Should the monitor break, care should be taken to avoid injury caused by broken glass and to prevent the liquid crystal from the display touching the skin or entering the eyes or mouth.

Do not Point the Lens at Strong Light Sources for Extended Periods

Avoid pointing the lens at the sun or other strong light sources for extended periods when using or storing the camera. Intense light may cause deterioration of the CCD image sensor, producing a white blur effect in photographs.

Keep Away from Strong Magnetic Fields

Do not use or store this device in the vicinity of equipment that generates strong electromagnetic radiation or magnetic fields. Strong static charges or the magnetic fields produced by equipment such as radio transmitters could interfere with the monitor, damage data stored on the memory card, or affect the product's internal circuitry.

Avoid Sudden Changes in Temperature

Sudden changes in temperature, such as when entering or leaving a heated building on a cold day, can cause condensation to form inside the device. To prevent condensation, place the device in a carrying case or a plastic bag before exposing it to sudden changes in temperature.

Turn the Product Off before Removing or Disconnecting the Power Source

Do not remove the battery while the product is on, or while images are being recorded or deleted. Forcibly cutting power in these circumstances could result in loss of data or in damage to product memory or internal circuitry.

 **The Battery**

- Check the battery level when taking the camera out, and charge the battery if necessary. Do not continue charging once the battery is fully charged, as this will result in reduced battery performance. If possible, carry a fully-charged spare battery when taking pictures on important occasions.
- Do not use the battery at ambient temperatures below 0 °C (32 °F) or above 40 °C (104 °F).
- Charge the battery indoors with an ambient temperature of 5 °C to 35 °C (41 °F to 95 °F) before use.
- Note that the battery may become hot during use; wait for the battery to cool before charging. Failure to observe these precautions could damage the battery, impair its performance or prevent it from charging normally.
- On cold days, the capacity of batteries tends to decrease. Be sure that the battery is fully charged before heading outside to take pictures in cold weather. Keep spare batteries in a warm place and exchange as necessary. Once warmed, a cold battery may recover some of its charge.
- Dirt on the battery terminals can prevent the camera from functioning. Should the battery terminals become dirty, wipe them off with a clean, dry cloth before use.
- If the battery will not be used for some time, insert it in the camera and run it flat before removing it for storage. The battery should be stored in a cool location with an ambient temperature of 15 to 25 °C (59 to 77 °F). Do not store the battery in hot or extremely cold locations.
- While the battery is in storage, charge it at least once every six months and then use the camera to run it flat again before storing it in a cool and dry place.
- Always remove the battery from the camera or battery charger when it is not being used. Left installed, minute amounts of current flow even when unused, and the battery may become excessively drained and no longer function. Turning the camera on or off while the battery is exhausted can result in reduced battery life.
- Recharge it at least once every six months and run it flat before returning it to storage.
- After removing the battery from the camera or battery charger, place it in the supplied battery case and store in a cool place.
- A marked drop in the time a fully-charged battery retains its charge, when used at room temperature, indicates that the battery needs to be replaced. Purchase a new EN-EL10 battery.
- Replace the battery when it no longer holds a charge. Used batteries are a valuable resource. Please recycle used batteries in accordance with local regulations.

Cleaning

Lens	Avoid touching glass parts with your fingers. Remove dust or lint with a blower (typically a small device with a rubber bulb attached to one end that is pumped to produce a stream of air out the other end). To remove fingerprints or other stains that cannot be removed with a blower, wipe the lens with a soft cloth, using a spiral motion that starts at the center of the lens and working toward the edges. If this fails, clean the lens using a cloth lightly dampened with commercial lens cleaner.
Monitor	Remove dust or lint with a blower. To remove fingerprints and other stains, clean the monitor with a soft, dry cloth, being careful not to apply pressure.
Body	Use a blower to remove dust, dirt or sand, then wipe gently with a soft, dry cloth. After using the camera at the beach or seaside, wipe off any sand or salt with a dry cloth lightly dampened with fresh water, then dry thoroughly. Note that foreign matter inside the camera could cause damage not covered by the warranty.

Do not use alcohol, thinner, or other volatile chemicals.

Storage

Turn the camera off when not in use. Check that the power-on lamp is off before putting the camera away. Remove the battery if the camera will not be used for an extended period. Do not store the camera with naphtha or camphor moth balls, or in any of the following locations:

- Next to equipment that produces strong electromagnetic fields, such as televisions or radios
- Exposed to temperatures below -10°C (14°F) or above 50°C (122°F)
- Poorly ventilated or subject to humidities of over 60 %











To prevent mold or mildew, take the camera out of storage at least once a month. Turn the camera on and release the shutter a few times before putting the camera away again.

Notes on the Monitor











- The monitor may contain a few pixels that are always lit or that do not light. This is a characteristic common to all TFT LCD displays, and does not indicate a malfunction. Images recorded using the product will not be affected.
- When framing bright subjects, vertical comet-like streaks that whiten toward either end may appear in the display. This phenomenon, known as “smear,” does not appear in the final photograph and does not indicate a malfunction. Some smear may appear in movies.
- Images in the monitor may be difficult to see under bright lighting.
- The monitor is lit by an LED backlight. Should the monitor begin to dim or flicker, contact your Nikon-authorized service representative.

Error Messages

The following table lists the error messages and other warnings displayed in the monitor, as well as the solutions for dealing with them.













Display	Problem	Solution	
 (blinks)	Clock not set.	Set clock.	136
	Battery running low.	Prepare to charge or change battery.	14
 Battery exhausted.	Battery exhausted.	Charge or change battery.	14
 Battery temperature high	Battery temperature is high.	Turn off camera, and allow battery to cool down before resuming use. After 5 seconds, this message will disappear, the monitor will turn off, and the power-on lamp and flash lamp will blink rapidly. After the lamps blink for 30 seconds, the camera will turn off automatically, but you can also press the power switch to turn it off manually.	17
 ● (● blinks red)	Camera cannot focus.	<ul style="list-style-type: none"> • Refocus. • Use focus lock. 	26, 27 125
 Memory card is write protected.	Write-protect switch is in "lock" position.	Slide write-protect switch to "write" position.	21
 This card cannot be used.	Error accessing memory card.	<ul style="list-style-type: none"> • Use approved card. • Check that connectors are clean. • Confirm that memory card is correctly inserted. 	150 20
 This card cannot be read.			20
 Card is not formatted. Format card? No Yes	Memory card has not been formatted for use in COOLPIX S60.	Tap Yes to format card, or turn camera off and replace card.	21

Error Messages

Display	Problem	Solution	
 Out of memory.	Memory card is full.	<ul style="list-style-type: none"> Choose smaller image size. Delete pictures or sound files. Insert new memory card. Remove memory card and use internal memory. 	116 28, 93, 97 20 20
 Image cannot be saved.	Error occurred while recording picture.	Format internal memory or memory card.	145
	Camera has run out of file numbers.	<ul style="list-style-type: none"> Insert new memory card. Format internal memory or memory card. 	20 145
	Picture cannot be used for welcome screen.	Choose a picture taken at any image mode setting other than  16:9 (3584) and  16:9 (1920) , or a small picture or cropped copy of 640x480 pixels or larger.	57, 63, 116
	Cannot copy picture.	Delete pictures from destination.	130
 Album is full. No further pictures can be added.	Over 200 pictures have already been added to favorites folder.	<ul style="list-style-type: none"> Remove some pictures from favorites folder. 	78
		<ul style="list-style-type: none"> Add to other favorites folders. 	75
 Sound file cannot be saved.	Camera has run out of file numbers.	<ul style="list-style-type: none"> Insert new memory card. Format internal memory or memory card. 	20 145
 Image cannot be modified.	Cannot edit selected picture.	Select picture that can be edited.	54
 Cannot record movie.	Time out error while recording movie.	Choose memory card with faster write speed.	150
 Playlists are full. Cannot create new HD Pictmotion.	30 HD Pictmotion slide shows have already been saved.	Delete unwanted HD Pictmotion slide shows and then create a new one.	86

Display	Problem	Solution	
i Memory contains no images.	No pictures in the internal memory or memory card.	Display the HOME screen to copy pictures from the camera's internal memory to the memory card. Display the playback menu and select Copy .	132
	No pictures are contained in the folder selected in auto sort mode.	Select the folder containing the sorted pictures.	69
	No pictures can be played back in auto sort mode.	Play back the pictures using playback mode or list by date mode.	70
	The picture has not been added to favorites folder.	<ul style="list-style-type: none"> • Add pictures to favorites folder. • Choose the favorites folder to which pictures have been added. 	75 78
i No sound file.	The memory card or internal memory contains no sound files.	Confirm the copy source and destination.	98
i File contains no image data.	File not created with COOLPIX S60.	View file on computer or other device.	-
i This file cannot be played back.			
i All images are hidden.	Date and time are not set for pictures to be displayed in list by date mode.	-	-
i This image cannot be deleted.	Picture is protected.	Disable protection.	131
i Travel destination is in the current time zone.	Destination in same time zone as home.	-	136
Lens error i	Lens error.	Turn camera off and then on again. If error persists, contact retailer or Nikon-authorized service representative.	22

Error Messages





Display	Problem	Solution	
Lens cover error 	Finger or other obstruction prevents lens cover from opening.	Turn camera off and remove obstruction.	4, 152
 Initializing lens. Cannot focus.	The camera cannot focus.	Wait for the camera to recover automatically.	–
 Communications error	USB cable disconnected during printing.	Turn camera off, reconnect USB cable.	106
System error 	Error has occurred in camera's internal circuitry.	Turn camera off, remove and reinsert battery, and turn camera on. If error persists, contact retailer or Nikon-authorized service representative.	16, 22
 Printer error: check printer status.	Running out of ink or printer error.	Check printer. After checking the ink or solving the problem, tap Resume to resume printing.*	–
 Printer error: check paper	Specified size of paper is not loaded in printer.	Load the specified paper, tap Resume to resume printing.*	–
 Printer error: paper jam	Paper has jammed in the printer.	Eject the jammed paper, tap Resume to resume printing.*	–
 Printer error: out of paper	No paper is loaded in printer.	Load the specified paper, tap Resume to resume printing.*	–
 Printer error: check ink	Ink error.	Check ink, tap Resume to resume printing.*	–
 Printer error: out of ink	Ink cartridge is empty.	Replace ink, tap Resume to resume printing.*	–
 Printer error: file corrupt	An error caused by the image file has occurred.	Tap Cancel to cancel printing.	–

* See the documentation provided with your printer for further guidance and information.

Troubleshooting

If the camera fails to function as expected, check the list of common problems below before consulting your retailer or Nikon-authorized service representative. Refer to the page numbers in the right-most column for more information.

Display, Settings and Power Supply

Problem	Cause/Solution	
Monitor is blank	<ul style="list-style-type: none"> • Camera is off. • Battery is exhausted. • Standby mode for saving power: press the shutter-release button halfway. • Camera and computer are connected via USB cable. • Time lapse or interval timer photography in progress. 	22 22 17, 26 102 –
Monitor is hard to read	<ul style="list-style-type: none"> • Adjust monitor brightness. • Monitor is dirty. Clean monitor. 	139 154
Camera turns off without warning	<ul style="list-style-type: none"> • Battery is low. • Camera has turned off automatically to save power. • Battery is cold. 	22 144 153
Date and time of recording are not correct	<ul style="list-style-type: none"> • Pictures recorded before clock was set, and “Date not set” indicator blinks during shooting, will have time stamp of “00/00/0000 00:00”; movies and voice recordings will be dated “01/01/2008 00:00.” Set the correct time and date from the Date option in the setup menu. • Check camera clock regularly against more accurate timepieces and reset as required. 	18 136
No indicators displayed in monitor	Hide info is selected for Photo info . Select Show info .	139
Date imprint not available	Camera clock has not been set.	18, 136
Date not appearing on pictures even when Date imprint is enabled	Date does not appear on movies or on pictures taken using  (Sports),  (Museum),  (Panorama assist) or when the Continuous setting is set to Continuous or BSS .	38, 41, 42, 87, 121
Camera settings reset	Backup battery is exhausted; all settings were restored to their default values.	137









Problem	Cause/Solution	
Monitor turns off, and the power-on lamp and flash lamp blink rapidly.	Battery temperature is high. Turn off camera, and allow battery to cool down before resuming use. After the lamps blink for 30 seconds, the camera will turn off automatically, but you can also press the power switch to turn it off manually.	17





Electronically Controlled Cameras

In extremely rare instances, unusual characters may appear in the monitor and the camera may stop functioning. In most cases, this phenomenon is caused by a strong external static charge. Turn the camera off, remove and replace the battery, then turn the camera on again. In the event of continued malfunction, contact your retailer or Nikon-authorized service representative. Note that disconnecting the power source as described above may result in the loss of any data not recorded to internal memory or the memory card at the time the problem occurred. Data already recorded will not be affected.

Shooting

Problem	Cause/Solution	
No picture taken when shutter-release button is pressed.	<ul style="list-style-type: none"> When camera is in playback mode or menus are displayed, press the shutter-release button. Battery is exhausted. When flash control blinks, flash is charging. 	28 22 31
Camera cannot focus.	<ul style="list-style-type: none"> The intended subject is one with which autofocus does not perform well. Set AF assist in the setup menu to Auto. Focus error. Turn camera off and then on again. 	27 142 22
Pictures are blurred.	<ul style="list-style-type: none"> Use flash. Use ISO sensitivity>High ISO sensitivity auto in the shooting menu. Use vibration reduction. Use BSS (Best Shot Selector). Use tripod and self-timer. 	30 123 142 121 32
Bright specks appear in pictures taken with flash.	Flash is reflecting off particles in air. Turn flash off.	31

Problem	Cause/Solution	
Flash does not fire.	<ul style="list-style-type: none"> Flash is off. Some scene modes that cannot turn on flash are selected.  modes other than Time-lapse movie ★ is selected. Continuous, Multi-shot 16 or BSS is selected for the Continuous setting. 	30 36 87 121
Optical zoom cannot be used.	Optical zoom cannot be used while recording movies.	87
Digital zoom cannot be used.	<ul style="list-style-type: none"> Digital zoom is set to Off in the setup menu. Digital zoom is not available in the following situations. <ul style="list-style-type: none"> When Scene auto selector, Portrait, or Night portrait is selected in scene mode When shooting with the smile timer Before movie recording begins (however, digital zoom of up to 2x can be applied while movies, other than time-lapse movies, are being recorded) When Multi-shot 16 is selected for the Continuous setting 	143 37, 38 33 87 121
Image mode not available.	<ul style="list-style-type: none"> Image mode cannot be adjusted when Multi-shot 16 is selected for the Continuous setting. When ISO sensitivity in the shooting menu is set to 3200, Image mode cannot be set to  High (3648 ★),  Normal (3648), or  16:9 (3584). 	121 123
Camera does not shoot with Multi-shot 16 .	At an ISO sensitivity setting of 3200 , the Multi-shot 16 option is not available. When shooting with the Multi-shot 16 option, select any option other than 3200 for ISO sensitivity and select Multi-shot 16 for Continuous .	121, 123
No sound when shutter is released.	<ul style="list-style-type: none"> Off is selected for Sound settings>Shutter sound in setup menu. Continuous or Multi-shot 16 or BSS is selected for the Continuous setting in shooting menu.  (Sports scene mode) or  (Museum scene mode) is selected.  mode is selected. Do not block the speaker. 	143 121 38, 41 87 4

Problem	Cause/Solution	
AF-assist illuminator does not light.	<ul style="list-style-type: none"> • Off is selected for AF assist option in camera setup menu. • AF-assist illuminator turns off automatically in some modes. 	142 37-42
Pictures appear smeared.	Lens is dirty. Clean lens.	154
Colors are unnatural.	White balance does not match light source.	118
Randomly spaced bright pixels ("noise") appear in image.	Shutter speed too slow. Noise can be reduced by: <ul style="list-style-type: none"> • Using flash • Specifying a lower ISO sensitivity setting • Using a scene mode which has noise reduction ability. 	30 123 37-42
Pictures are too dark (underexposed).	<ul style="list-style-type: none"> • Flash is off. • Flash window is blocked. • Subject is beyond flash range. • Adjust exposure compensation. • Select High ISO sensitivity auto for ISO sensitivity in the shooting menu, or raise the ISO sensitivity. • Subject is backlit. Select  (Backlight scene mode) or use fill flash. 	30 24 30 120 123 30, 42
Pictures are too bright (overexposed).	Adjust exposure compensation.	120
Unexpected results when flash set to  (auto with red-eye reduction).	When  (auto with red-eye reduction) or "fill flash with slow sync and red-eye reduction" of the Night portrait scene mode is applied during shooting, In-Camera Red-Eye Fix may, in very rare cases, be applied to areas not affected by red-eye. Set a flash mode other than  (auto with red-eye reduction) and select a shooting mode other than Night portrait scene mode, then shoot.	30, 38

Playback

Problem	Cause/Solution	
File cannot be played back.	<ul style="list-style-type: none"> • File was overwritten or renamed by computer or other make of camera. • Time-lapse or interval timer photography in progress; pictures cannot be played back until recording is complete. 	– 91, 122
Cannot zoom in on picture.	Playback zoom cannot be used with movies, small pictures, or pictures that have been cropped to below 320 × 240.	–

Problem	Cause/Solution	
Cannot record or play back voice memo.	<ul style="list-style-type: none"> • Voice memos cannot be appended to movies. • Voice memos cannot be attached to images taken with other cameras. Voice memos that are attached to the image using other cameras cannot be played back on this camera. 	93 65
Cannot edit pictures.	<ul style="list-style-type: none"> • These options cannot be used with movies. • Select pictures that support editing functions. • Pictures taken with another make or model of camera cannot be edited. • Other cameras may be unable to play back, or transfer to a computer, pictures edited with this camera. 	93 54 54 54
Pictures not displayed on television.	<ul style="list-style-type: none"> • Choose the correct Video mode and HDMI options from the TV settings item. • Screen cannot be displayed on a television. • Memory card contains no pictures. Replace memory card. Remove memory card to play back pictures from internal memory. 	146 100 20
Control settings for favorites folder restore to default settings, or pictures added to favorites are not displayed during favorite pictures playback.	Date in the memory card may not be played back correctly if overwritten on a computer.	-
The recorded pictures are not displayed in auto sort mode.	<ul style="list-style-type: none"> • The picture you want to display is sorted in a folder other than that you are browsing. • Pictures recorded by a camera other than the COOLPIX S60 or pictures copied using the Copy option cannot be displayed in auto sort mode. • Pictures in the internal memory or memory card may not be played back correctly if overwritten on a computer. • Up to 999 pictures and movie files can be added to each folder. If the desired folder already contains 999 pictures, new pictures or movies cannot be added. 	69 132 - 70

Troubleshooting

Problem	Cause/Solution	
Nikon Transfer does not start when camera is connected.	<ul style="list-style-type: none"> • Camera is off. • Battery is exhausted. • USB cable is not correctly connected. • If your computer is running Windows 2000 Professional, camera cannot be connected to the computer. • Camera is not recognized by the computer. • Computer is not set to launch Nikon Transfer automatically. <p>For more information on Nikon Transfer, refer to help information contained in Nikon Transfer.</p>	<p>22 22 102 101</p> <p>– –</p>
Pictures to be printed are not displayed.	Memory card contains no pictures. Replace memory card. Remove memory card to print pictures from internal memory.	20
Cannot select paper size with camera.	Paper size cannot be selected from the camera if the printer does not support the paper sizes used by the camera, or the printer automatically selects the paper size. Use the printer to select paper size.	107, 108

Specifications

Nikon COOLPIX S60 Digital Camera

Type	Compact digital camera
Effective pixels	10.0 million
Image sensor	¹ /2.3-in. CCD; total pixels: 10.34 million
Lens	5x optical zoom, NIKKOR lens
Focal length	5.9-29.5mm (equivalent with 35mm [135] format picture angle: 33-165mm)
f/-number	f/3.8-4.8
Construction	12 elements in 10 groups
Digital zoom	Up to 4x (equivalent with 35mm [135] format picture angle: approx. 660mm)
Vibration reduction	Image-sensor shift
Autofocus (AF)	Contrast-detect AF
Focus range (from lens)	<ul style="list-style-type: none">• Approx. 60 cm (2 ft.) to ∞(W); approx. 100 cm (3 ft. 4 in.) to ∞ (T)• Macro mode: 9 cm (3.6 in.) (wide-angle zoom position) to ∞
Focus-area selection	Face priority, center, manual (focus area can be selected using the touch panel)
Monitor	3.5-in. widescreen, Approx. 230k-dot, TFT LCD (touch panel) with anti-reflection coating and 5-level brightness adjustment
Frame coverage (shooting mode)	Approx. 98 % horizontal and 98 % vertical (Compared to actual picture)
Frame coverage (playback mode)	Approx. 100 % horizontal and 100 % vertical (Compared to actual picture)
Storage	
Media	<ul style="list-style-type: none">• Internal memory (approx. 20 MB)• SD (Secure Digital) memory cards
File system	DCF, Exif 2.2, and DPOF compliant
File formats	Compressed: JPEG-Baseline compliant Movies: AVI Sound files: WAV
Image size (pixels)	<ul style="list-style-type: none">• 3,648 × 2,736 High (3648★)/Normal (3648)• 2,592 × 1,944 Normal (2592)• 2,048 × 1,536 Normal (2048)• 1,024 × 768 PC screen (1024)• 640 × 480 TV screen (640)• 3,584 × 2,016 16:9 (3584)• 1,920 × 1,080 16:9 (1920)

Specifications

ISO sensitivity (Standard output sensitivity)	ISO 64, 100, 200, 400, 800, 1600, 2000, 3200, Auto (auto gain from ISO 64 to 800), High ISO sensitivity auto (64 to 1600)
Exposure	
Metering	256-segment matrix, center-weighted (digital zoom less than 2x), spot (digital zoom 2x or more)
Exposure control	Programmed auto exposure with exposure compensation (-2.0 to +2.0 EV in steps of 1/3 EV)
Range (ISO 100)	[W]: 1 to 16.6 EV [T]: 1.6 to 17.3 EV
Shutter	Mechanical and charge-coupled electronic shutter
Speed	1/1500-2 s, 4 s (Fireworks show scene mode)
Aperture	Electronically-controlled preset aperture
Range	2 steps (f/3.8 and f/6.4 [W])
Self-timer	Can be selected from 10 and 2 second duration, or smile timer
Built-in flash	
Range (ISO sensitivity: Auto)	[W]: 0.6 to 3.8 m (2 to 12 ft.) [T]: 1.0 to 3.0 m (3 ft. 4 in. to 9 ft.)
Flash control	TTL auto flash with monitor preflashes
Interface	Hi-Speed USB
Video output	Can be selected from NTSC and PAL
I/O terminal	Multi connector (USB, audio/video output, DC input) HDMI Mini Connector (high-definition output)
Supported languages	Arabic, Chinese (Simplified and Traditional), Czech, Danish, Dutch, English, Finnish, French, Greek, German, Hungarian, Indonesian, Italian, Japanese, Korean, Polish, Portuguese, Norwegian, Russian, Spanish, Swedish, Thai, Turkish
Power sources	One EN-EL10 Rechargeable Li-ion Battery (supplied) AC Adapter EH-63 (available separately)
Battery life*	Approx. 140 shots (EN-EL10)
Dimensions (W × H × D)	Approx. 97.5 × 60 × 22 mm (3.9 × 2.4 × 0.9 in.) (excluding projections)
Weight	Approx. 145 g (5.2 oz) (without battery and SD memory card)
Operating environment	
Temperature	0 to 40 °C (32 to 104 °F)
Humidity	Less than 85 % (no condensation)

- Unless otherwise stated, all figures are for a camera with a fully-charged Rechargeable Li-ion Battery EN-EL10 operated at an ambient temperature of 25 °C (77 °F).
- * Based on Camera and Imaging Products Association (CIPA) standards for measuring the life of camera batteries. Measured at 23 °C (73 °F); zoom adjusted with each shot, flash fired with every other shot, image mode set to  **Normal (3648)**. Battery life may vary depending on shooting interval and length of time menus and images are displayed.

Rechargeable Li-ion Battery EN-EL10

Type	Rechargeable lithium-ion battery
Rated capacity	DC 3.7 V, 740 mAh
Operating temperature	0 to 40 °C (32 to 104 °F)
Dimensions (W × H × D)	Approx. 31.5 × 39.5 × 6 mm (1.2 × 1.5 × 0.2 in.) (excluding projections)
Weight	Approx. 15 g (0.5 oz) (excluding battery case)

Battery Charger MH-63

Rated input	AC 100-240 V, 50/60 Hz, 0.07-0.045 A
Rated capacity	7-10.8 VA
Rated output	DC 4.2 V, 0.55 A
Applicable batteries	Rechargeable Li-ion Battery EN-EL10
Charging time	Approx. 100 minutes when no charge remains
Operating temperature	0 to 40 °C (32 to 104 °F)
Dimensions (W × H × D)	Approx. 54 × 20 × 85 mm (2.1 × 0.7 × 3.3 in.) (excluding power cable)
Length of power cable	Approx. 1.8 m (6 ft.)
Weight	Approx. 55 g (1.9 oz) (excluding power cable)

Specifications

Nikon will not be held liable for any errors this manual may contain. The appearance of this product and its specifications are subject to change without notice.

Supported Standards

- **DCF:** Design Rule for Camera File System is a standard widely used in the digital camera industry to ensure compatibility among different makes of camera.
- **DPOF:** Digital Print Order Format is an industry-wide standard that allows pictures to be printed from print orders stored on the memory card.
- **Exif version 2.2:** This camera supports Exif (Exchangeable Image File Format for Digital Still Cameras) version 2.2, a standard that allows information stored with photographs to be used for optimal color reproduction when images are output from Exif-compliant printers.
- **PictBridge:** A standard developed cooperatively by the digital camera and printer industries, allowing photographs to be output directly to a printer without connecting the camera to a computer.

Index

Symbols

51

Vibration reduction 142

(tele) 25

(wide) 25

53

52

Auto mode 22

Scene mode 36

Movie mode 87

Playback mode 28

Delete 28, 65, 93, 97

List by date mode 66

Auto sort mode 69

Favorite pictures mode 79

Self-timer mode 32

Flash mode 30

Macro mode 35

A

AC adapter 150

AF area mode 124

AF-assist illumination 4, 27, 142

Audio/video cable 99, 101, 102, 106

Audio-in/video-in jack 99

Auto flash 30

Auto mode 22

Auto off 144

Auto sort mode 69

Autofocus 90

Autofocus mode 90

AVI 151

B

Back light 42

Battery 14, 16, 137

Battery charger 14, 150

Battery latch 5

Battery level 22

Battery-chamber 5

Battery-chamber/memory card slot cover
5, 16

Beach/snow 39

Best Shot Selector 121

Blink warning 146

Brightness 139

BSS 121

Built-in flash 4, 30

Built-in microphone 4

Button sound 143

C

Cable connector 101

Close-up 40

Cloudy 118

Compression ratio 116

Computer 101, 101–104
copying pictures to 101–104

Continuous 121

Copy 41

Copying pictures 132

Copying voice recordings 98

Crop 57

D

Date 136

Date counter 140, 141

Date imprint 140

Daylight 118

Daylight saving time 18, 137

Delete 130

Digital zoom 25, 143

Direct print 105

Distortion control 127

D-Lighting 61

Drag 6



Draw 42, 49

Dusk/dawn 39

E

Electronic VR 90
EN-EL10 14, 16
Exp.+/- 120
Exposure compensation 120
Extension 151
Eyelet for camera strap 5

F

Face priority 124, 126
File names 151
Fill flash 30
Fireworks show  41
Firmware version 149
Flash 30, 31
Flash lamp 31
Flash off 30
Fluorescent 118
Focus 4, 26, 90, 124
Focus lock 125
Folder name 151
Food  47
Format 21, 145
Format memory card 21, 145
Formatting internal memory 145
Full-time AF 90

H

Halfway 4
HDMI 146
HDMI cable 99
High ISO sensitivity auto 123
HOME screen 12
 burgundy 134
 display design 134
 lights 134
 metallic 134

I

Identifier 151

Image mode 116
Image size 116
Incandescent 118
Intvl timer shooting 122
ISO sensitivity 123

J

JPG 151

L

Language 146
Lens 4, 165
Li-ion rechargeable battery 14, 16
List by date mode 66

M

Macro mode 35
Making voice recordings 94
Memory capacity 22, 117
Memory card 20, 150
Memory card slot 5, 20
Monitor 5, 154
Monitor settings 139
Movie menu 88
Movie playback 93
Movie settings 88
Multi connector 5, 99, 106
Multi-shot 16 121
Museum  41



N

Night landscape  40
Night portrait  38
Nikon Transfer 101, 102
Noise reduction 38, 39, 40
Number of exposures remaining 22, 117

O

Optional accessories 150

P

Paint 55
 Panorama assist  42, 50
 Paper size 107
 Party/indoor  38
 Perspective control 60
 Photo info 139
 PictBridge 105
 Playback 29, 52, 53
 Playback menu 129
 Playback zoom 53
 Playing voice recordings 96
 Portrait  37
 Power 18, 22
 Power switch 4, 22
 Power-on lamp 4, 22
 Preset manual 119
 Print 107, 108, 111
 Print Set 111
 Printer 105
 Protect 131

R

Rechargeable battery 150
 Rechargeable Li-ion battery 14, 16
 Record orientation 144
 Recording movies 87
 Red-eye reduction 30, 31
 Reset all 147
 Rotate image 131

S

Scene auto selector 43
 Scene auto selector  37
 Scene mode 36, 37
 Self-timer 32
 Self-timer lamp 4, 32
 Setup menu 133
 Shooting 22, 24, 26
 Shooting menu 115

Shutter sound 143
 Shutter-release button 4, 26
 Single 121
 Single AF 90
 Slow Sync 30
 Small picture 63
 Smile timer 33
 Sound settings 143
 Speaker 4
 Sports  38
 Strap 5
 Stretch 59
 Sunset  39

T

Tap 6
 Thumbnail playback 52
 Time zone 136, 138
 Time-lapse movies 91
 Touch AF/AE 24
 Transfer 102
 Tripod socket 5
 TV 99
 TV movie 88, 89

U

USB cable 101, 102, 106

V

Video mode 100, 146
 Voice memo 64
 Voice recording  94, 96
 Volume 93, 97

W

WAV 151
 Welcome screen 135
 White balance 118

Nikon

No reproduction in any form of this manual, in whole or in part (except for brief quotation in critical articles or reviews), may be made without written authorization from NIKON CORPORATION.

NIKON CORPORATION

Fuji Bldg., 2-3 Marunouchi 3-chome,
Chiyoda-ku, Tokyo 100-8331, Japan

© 2008 Nikon Corporation



YP8H01(11)
6MM62811-01