

Nikon

DIGITAL CAMERA

COOLPIX S4000

User's Manual

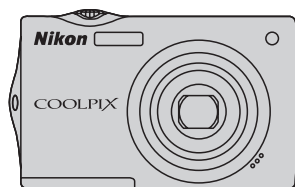

En

Trademark Information

- Microsoft, Windows and Windows Vista are either registered trademarks or trademarks of Microsoft Corporation in the United States and/or other countries.
- Macintosh, Mac OS, and QuickTime are trademarks of Apple Inc.
- Adobe and Acrobat are registered trademarks of Adobe Systems Inc.
- SD and SDHC Logos are trademarks of SD-3C, LLC.
- PictBridge is a trademark.
- All other trade names mentioned in this manual or the other documentation provided with your Nikon product are trademarks or registered trademarks of their respective holders.

Introduction

First Steps

Basic Photography and Playback: 📷 (Auto) Mode

More on Shooting

More on Playback

Editing Pictures

Movie Recording and Playback

Connecting to Televisions, Computers and Printers

Basic Camera Setup

Caring for the Camera

Technical Notes and Index

For Your Safety

To prevent damage to your Nikon product or injury to yourself or to others, read the following safety precautions in their entirety before using this equipment. Keep these safety instructions where all those who use the product will read them.



This icon marks warnings, information that should be read before using this Nikon product, to prevent possible injury.

WARNINGS

Turn off in the event of malfunction

Should you notice smoke or an unusual smell coming from the camera or AC adapter, unplug the AC adapter and remove the battery immediately, taking care to avoid burns. Continued operation could result in injury. After removing or disconnecting the power source, take the equipment to a Nikon-authorized service representative for inspection.

Do not disassemble

Touching the internal parts of the camera or AC adapter could result in injury. Repairs should be performed only by qualified technicians. Should the camera or AC adapter break open as the result of a fall or other accident, take the product to a Nikon-authorized service representative for inspection, after unplugging the product and/or removing the battery.

Do not use the camera or AC adapter in the presence of flammable gas

Do not use electronic equipment in the presence of flammable gas, as this could result in explosion or fire.

Handle the camera strap with care

Never place the strap around the neck of an infant or child.

Keep out of reach of children

Particular care should be taken to prevent infants from putting the battery or other small parts into their mouths.

Observe caution when handling the battery

The battery may leak or explode if improperly handled. Observe the following precautions when handling the battery for use in this product:

- Before replacing the battery, turn the product off. If you are using the Charging AC Adapter/AC adapter, be sure it is unplugged.
- Use only a Rechargeable Li-ion Battery EN-EL10 (supplied). Charge the battery inserting it into the camera and connecting the Charging AC Adapter EH-68P/EH-68P (AR) (supplied).
- When inserting the battery, do not attempt to insert it upside down or backwards.
- Do not short or disassemble the battery or attempt to remove or break the battery insulation or casing.
- Do not expose the battery to flame or to excessive heat.
- Do not immerse in or expose to water.
- Return the battery to the battery case for transportation. Do not transport or store with metal objects such as necklaces or hairpins.
- The battery is prone to leakage when fully discharged. To avoid damage to the product, be sure to remove the battery when no charge remains.
- Discontinue use immediately should you notice any change in the battery, such as discoloration or deformation.

Observe the following precautions when handling the Charging AC Adapter

- If liquid from the damaged battery comes in contact with clothing or skin, rinse immediately with plenty of water.
- Keep dry. Failure to observe this precaution could result in fire or electric shock.
- Dust on or near the metal parts of the plug should be removed with a dry cloth. Continued use could result in fire.
- Do not handle the cable or go near the Charging AC Adapter during lightning storms. Failure to observe this precaution could result in electric shock.
- Do not damage, modify, forcibly tug or bend the power cable, place it under heavy objects, or expose it to heat or flames. Should the insulation be damaged and the wires become exposed, take it to a Nikon-authorized service representative for inspection. Failure to observe these precautions could result in fire or electric shock.
- Do not handle the plug or Charging AC Adapter with wet hands. Failure to observe this precaution could result in electric shock.
- Do not use with travel converters or adapters designed to convert from one voltage to another or with DC-to-AC inverters. Failure to observe this precaution could damage the product or cause overheating or fire.

 **Use appropriate cables**

When connecting cables to the input and output jacks, use only the cables provided or sold by Nikon for the purpose, to maintain compliance with product regulations.

 **Handle moving parts with care**

Be careful that your fingers or other objects are not pinched by the lens cover or other moving parts.

 **CD-ROMs**

The CD-ROMs supplied with this device should not be played back on audio CD equipment. Playing CD-ROMs on an audio CD player could cause hearing loss or damage the equipment.

 **Observe caution when using the flash**

Using the flash close to your subject's eyes could cause temporary visual impairment. Particular care should be observed if photographing infants, when the flash should be no less than one meter (3 ft. 4 in.) from the subject.

 **Do not operate the flash with the flash window touching a person or object**

Failure to observe this precaution could result in burns or fire.

 **Avoid contact with liquid crystal**

Should the monitor break, care should be taken to avoid injury caused by broken glass and to prevent liquid crystal from the monitor touching the skin or entering the eyes or mouth.

 **Turn the power off when using inside an airplane or the hospital**

Turn the power off while inside the airplane during take off or landing. Follow the instructions of the hospital when using while in a hospital. The electromagnetic waves given out by this camera may disrupt the electronic systems of the airplane or the instruments of the hospital.

Notices

Notice for Customers in the U.S.A.

Federal Communications Commission (FCC) Radio Frequency Interference Statement

This equipment has been tested and found to comply with the limits for a Class B digital device, pursuant to Part 15 of the FCC rules. These limits are designed to provide reasonable protection against harmful interference in a residential installation. This equipment generates, uses, and can radiate radio frequency energy and, if not installed and used in accordance with the instructions, may cause harmful interference to radio communications. However, there is no guarantee that interference will not occur in a particular installation. If this equipment does cause harmful interference to radio or television reception, which can be determined by turning the equipment off and on, the user is encouraged to try to correct the interference by one or more of the following measures:

- Reorient or relocate the receiving antenna.
- Increase the separation between the equipment and receiver.
- Connect the equipment into an outlet on a circuit different from that to which the receiver is connected.
- Consult the dealer or an experienced radio/television technician for help.



Nikon
COOLPIX S4000

CAUTIONS

Modifications

The FCC requires the user to be notified that any changes or modifications made to this device that are not expressly approved by Nikon Corporation may void the user's authority to operate the equipment.

Interface Cables

Use the interface cables sold or provided by Nikon for your equipment. Using other interface cables may exceed the limits of Class B Part 15 of the FCC rules.

Notice for customers in the State of California

WARNING

Handling the cord on this product will expose you to lead, a chemical known to the State of California to cause birth defects or other reproductive harm.

Wash hands after handling.

Nikon Inc.,
1300 Walt Whitman Road
Melville, New York 11747-3064
USA
Tel: 631-547-4200

Notice for customers in Canada

CAUTION

This Class B digital apparatus complies with Canadian ICES-003.

ATTENTION

Cet appareil numérique de la classe B est conforme à la norme NMB-003 du Canada.

Notice for customers in Europe

This symbol indicates that this product is to be collected separately.



The following apply only to users in European countries:

- This product is designated for separate collection at an appropriate collection point. Do not dispose of as household waste.
- For more information, contact the retailer or the local authorities in charge of waste management.

This symbol on the battery indicates that the battery is to be collected separately.



The following apply only to users in European countries:

- All batteries, whether marked with this symbol or not, are designated for separate collection at an appropriate collection point. Do not dispose of as household waste.
- For more information, contact the retailer or the local authorities in charge of waste management.

Table of Contents





For Your Safety	ii
WARNINGS.....	ii
Notices	v
<hr/>	
Introduction	1
About This Manual	1
Information and Precautions.....	2
Parts of the Camera	4
The Camera Body	4
Basic Operations.....	6
The  (Shooting Mode) Button.....	6
The  (Playback) Button.....	6
Shutter-release Button	7
Attaching the Camera Strap	7
Operating the Touch Panel	8
Tapping.....	8
Dragging.....	8
Using the Stylus	9
Main Display of the Monitor/Touch Panel and Basic Operations.....	10
Shooting (Operation Controls).....	10
Shooting (Other Indicators).....	11
Playback (Operation Controls).....	12
Playback (Information Display).....	13
The Menu Screen.....	14
Help Display	15
<hr/>	
First Steps.....	16
Inserting the Battery	16
Removing the Battery	17
Charging the Battery	18
Turning On and Off the Camera.....	21
Setting Display Language, Date and Time	22
Inserting Memory Cards	24
Removing Memory Cards.....	24
<hr/>	
Basic Photography and Playback:  (Auto) Mode.....	26
Step 1 Turn the Camera On and Select  (Auto) Mode	26
Indicators Displayed in  (Auto) Mode	27
Step 2 Frame a Picture	28
Using the Zoom.....	29
Step 3 Focus and Shoot	30
Step 4 Playing Back and Deleting Pictures	32

Table of Contents

Playing Back Pictures (Playback Mode).....	32
Deleting Pictures.....	33
Tapping the Monitor to Release the Shutter (Touch Shutter).....	34
Tapping the Monitor to Focus (Touch AF/AE).....	37
Focusing on a Moving Subject (Subject Tracking).....	40
Using the Flash.....	42
Setting the Flash Mode.....	42
Taking Pictures with the Self-timer.....	44
Macro Mode.....	45
<hr/>	
More on Shooting.....	46
Selecting a Shooting Mode.....	46
Shooting Options: Shooting Menu (📷 (Auto) Mode).....	47
Image Mode (Image Quality/Image Size).....	48
White Balance (Adjusting Hue).....	50
Exposure Comp. (Adjusting Brightness).....	52
Continuous.....	53
ISO Sensitivity.....	54
AF Area Mode.....	55
Autofocus Mode.....	57
Camera Settings that Cannot Be Applied Simultaneously.....	58
Shooting Suited to Scenes (Scene Mode).....	59
Setting a Scene Mode.....	59
Shooting in the Scene Mode Selected by the Camera (Scene Auto Selector).....	60
Selecting a Scene Mode to Take Pictures (Features).....	62
Using the Draw Option.....	69
Shooting for a Panorama.....	70
Shooting Smiling Faces (Smart Portrait Mode).....	72
Smart Portrait Menu.....	74
<hr/>	
More on Playback.....	75
Operations in Full-frame Playback Mode.....	75
Viewing Multiple Pictures: Thumbnail Playback.....	77
Taking a Closer Look: Playback Zoom.....	79
Selecting Playback Mode.....	80
Sorting Favorite Pictures (Favorite Pictures Mode).....	81
Adding Pictures to Albums.....	81
Viewing Pictures in an Album.....	83
Removing Pictures from Albums.....	84
Using Favorite Pictures Mode.....	85
Favorite Pictures Menu.....	85
Changing Icons Assigned to Albums.....	86
Image Searching in Auto Sort Mode.....	88









Viewing Pictures in Auto Sort Mode.....	88
Using Auto Sort Mode.....	90
Auto Sort Menu	90
Viewing Pictures by Date (List by Date Mode)	91
Selecting a Date in List by Date Mode	91
Using List by Date Mode.....	92
List by Date Menu	92
Playback Options: The Playback Menu	93
Print Set (Creating a DPOF Print Order).....	94
Slide Show.....	97
Delete (Deleting Multiple Pictures).....	98
Protect	100
Copy (Copy Between Internal Memory and Memory Card)	100
Rotate Image	102
Voice Memos: Recording and Playback	103
Recording Voice Memos.....	103
Playing Voice Memos.....	104
Deleting Voice Memos.....	104
<hr/>	
Editing Pictures	105
Editing Functions.....	105
Picture Editing.....	107
 Paint: Painting Pictures.....	107
 Quick Retouch: Enhancing Contrast and Saturation.....	110
 D-Lighting: Enhancing Brightness and Contrast	111
 Skin Softening: Softening Skin Tones	112
 Stretch: Stretching Pictures.....	114
 Perspective Control: Adjusting a Sense of Perspective	115
 Small Picture: Resizing Pictures.....	116
 Color Options: Modifying Color Tones.....	117
 Crop: Creating a Cropped Copy	118
<hr/>	
Movie Recording and Playback	119
Recording Movies	119
Movie Menu.....	121
Movie Options.....	121
Autofocus Mode.....	122
Electronic VR	122
Movie Playback.....	123
Deleting Movie.....	123
<hr/>	
Connecting to Televisions, Computers and Printers	124
Connecting to a TV.....	124

Table of Contents

Connecting to a Computer	126
Before Connecting the Camera.....	126
Transferring Pictures from a Camera to a Computer.....	127
Charging While Connecting to a Computer.....	131
Connecting to a Printer	132
Connecting the Camera to a Printer.....	133
Printing Pictures One at a Time.....	134
Printing Multiple Pictures.....	135
<hr/>	
Basic Camera Setup	138
Setup Menu	138
Welcome Screen.....	140
Date.....	141
Monitor Settings.....	144
Date Imprint (Imprinting Date and Time).....	144
Electronic VR.....	145
Motion Detection.....	146
AF Assist.....	147
Digital Zoom.....	148
Sound Settings.....	148
Auto Off.....	149
Format Memory/Format Card.....	150
Language.....	151
Video Mode.....	151
Charge by Computer.....	152
Blink Warning.....	152
Reset All.....	154
Firmware Version.....	156
<hr/>	
Caring for the Camera	157
Maximizing Camera Life and Performance	157
Cleaning.....	159
Storage.....	159
<hr/>	
Technical Notes and Index	160
Optional Accessories	160
Approved Memory Cards.....	161
Image/Sound File and Folder Names	162
Error Messages	163
Troubleshooting	167
Specifications	174
Supported Standards.....	177
Index	178

About This Manual

Thank you for your purchase of a Nikon COOLPIX S4000 digital camera. This manual was written to help you enjoy taking pictures with your Nikon digital camera. Read this manual thoroughly before use, and keep it where all those who use the product will read it.

Symbols and Conventions

To make it easier to find the information you need, the following symbols and conventions are used:



This icon marks cautions, information that should be read before use, to prevent damage to the camera.



This icon marks tips, additional information that may be helpful when using the camera.



This icon marks notes, information that should be read before using the camera.



This icon indicates that more information is available elsewhere in this manual.

Notations

- A Secure Digital (SD) memory card is referred to as a “memory card.”
- The setting at the time of purchase is referred to as the “default setting.”
- The names of menu items displayed in the camera monitor, and the names of buttons or messages displayed on a computer monitor appear in bold.

Screen Samples

In this manual, images are sometimes omitted from monitor display samples so that monitor indicators can be more clearly shown.

Illustrations and Screen Display

Illustrations and text displays shown in this manual may differ from actual display.

Internal Memory and Memory Cards

Pictures taken with this camera can be stored in the camera’s internal memory or on removable memory cards. If a memory card is inserted, all new pictures will be stored on the memory card and delete, playback and format operations will apply only to the pictures on the memory card. The memory card must be removed before the internal memory can be formatted or accessed for picture storage, deletion, or viewing.

Information and Precautions

Life-Long Learning

As part of Nikon's "Life-Long Learning" commitment to ongoing product support and education, continually updated information is available online at the following sites:

- For users in the U.S.A.: <http://www.nikonusa.com/>
- For users in Europe and Africa: <http://www.europe-nikon.com/support/>
- For users in Asia, Oceania, and the Middle East: <http://www.nikon-asia.com/>

Visit these sites to keep up-to-date with the latest product information, tips, answers to frequently asked questions (FAQs), and general advice on digital imaging and photography. Additional information may be available from the Nikon representative in your area. Visit the site below for contact information:

<http://imaging.nikon.com/>

Use Only Nikon Brand Electronic Accessories

Nikon COOLPIX cameras are designed to the highest standards and include complex electronic circuitry. Only Nikon brand electronic accessories (including battery chargers, batteries, Charging AC Adapter and AC adapters) certified by Nikon specifically for use with this Nikon digital camera are engineered and proven to operate within the operational and safety requirements of this electronic circuitry.

THE USE OF NON-NIKON ELECTRONIC ACCESSORIES COULD DAMAGE THE CAMERA AND MAY VOID YOUR NIKON WARRANTY.

The use of third-party rechargeable Li-ion batteries not bearing the Nikon holographic seal could interfere with normal operation of the camera or result in the batteries overheating, igniting, rupturing, or leaking.

For more information about Nikon brand accessories, contact a local authorized Nikon dealer.



Holographic seal:

Identifies this device as an authentic Nikon product.

Before Taking Important Pictures

Before taking pictures on important occasions (such as at weddings or before taking the camera on a trip), take a test shot to ensure that the camera is functioning normally. Nikon will not be held liable for damages or lost profits that may result from product malfunction.

About the Manuals

- No part of the manuals included with this product may be reproduced, transmitted, transcribed, stored in a retrieval system, or translated into any language in any form, by any means, without Nikon's prior written permission.
- Nikon reserves the right to change the specifications of the hardware and software described in these manuals at any time and without prior notice.
- Nikon will not be held liable for any damages resulting from the use of this product.
- While every effort was made to ensure that the information in these manuals is accurate and complete, we would appreciate it were you to bring any errors or omissions to the attention of the Nikon representative in your area (address provided separately).

Notice Concerning Prohibition of Copying or Reproduction

Note that simply being in possession of material that was digitally copied or reproduced by means of a scanner, digital camera or other device may be punishable by law.

- **Items prohibited by law from being copied or reproduced**

Do not copy or reproduce paper money, coins, securities, government bonds or local government bonds, even if such copies or reproductions are stamped "Sample." The copying or reproduction of paper money, coins, or securities which are circulated in a foreign country is prohibited. Unless the prior permission of the government was obtained, the copying or reproduction of unused postage stamps or post cards issued by the government is prohibited. The copying or reproduction of stamps issued by the government and of certified documents stipulated by law is prohibited.

- **Cautions on certain copies and reproductions**

The government has issued cautions on copies or reproductions of securities issued by private companies (shares, bills, checks, gift certificates, etc.), commuter passes or coupon tickets, except when a minimum of necessary copies are to be provided for business use by a company. Also, do not copy or reproduce passports issued by the government, licenses issued by public agencies and private groups, ID cards and tickets, such as passes and meal coupons.

- **Comply with copyright notices**

The copying or reproduction of copyrighted creative works such as books, music, paintings, woodcut prints, maps, drawings, movies and photographs is governed by national and international copyright laws. Do not use this product for the purpose of making illegal copies or to infringe copyright laws.

Disposing of Data Storage Devices

Please note that deleting images or formatting data storage devices such as memory cards or built-in camera memory does not completely erase the original image data. Deleted files can sometimes be recovered from discarded storage devices using commercially available software, potentially resulting in the malicious use of personal image data. Ensuring the privacy of such data is the user's responsibility.

Before discarding a data storage device or transferring ownership to another person, erase all data using commercial deletion software, or format the device and then completely refill it with images containing no private information (for example, pictures of empty sky). Be sure to also replace any pictures selected for the welcome screen (📖 140). Care should be taken to avoid injury or damage to property when physically destroying data storage devices.

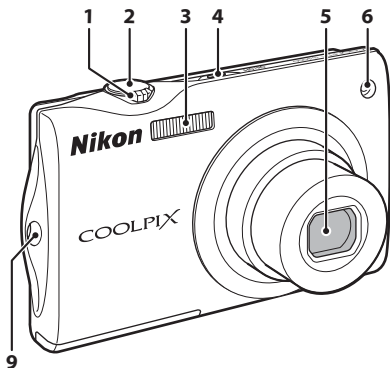

Parts of the Camera

The Camera Body

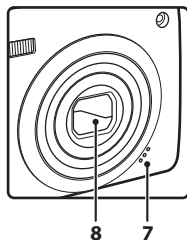

Lens cover closed



1	Zoom control.....29	5	Lens 159, 174
	W : wide29	6	Self-timer lamp.....44
	T : tele29	7	AF-assist illuminator147
	 thumbnail playback.....77	8	Built-in microphone..... 103, 119
	 playback zoom.....79	9	Lens cover157
2	Shutter-release button.....30		Eyelet for camera strap..... 7
3	Built-in flash.....42		
4	Power switch/power-on lamp26, 149		

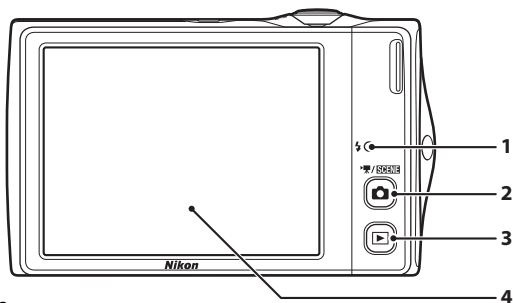

Opening the connector cover

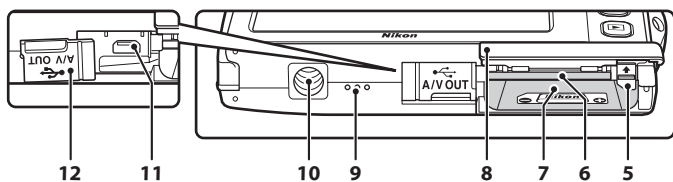





1	Charge lamp.....	19, 131
	Flash lamp.....	43
2	📷 (shooting mode) button.....	6, 46
3	▶ (playback) button.....	6, 32, 80
4	Monitor/touch panel.....	10
5	Battery latch.....	16, 17
6	Memory card slot.....	24

7	Battery chamber.....	16
8	Battery-chamber/ memory card slot cover.....	16, 24
9	Speaker.....	104, 123
10	Tripod socket	
11	USB/audio/video output connector	124, 127, 133
12	Connector cover.....	124, 127, 133

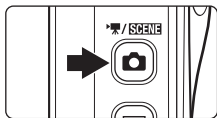
Basic Operations





The (Shooting Mode) Button

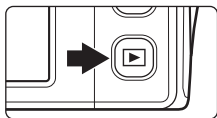

- Press the  button in playback mode to enter shooting mode.
- Press the  button in shooting mode to display the shooting-mode selection menu and switch shooting modes ( 46).

The (Playback) Button



- Press the  button in shooting mode to enter playback mode.
- Press the  button in playback mode to display the playback-mode selection menu and switch playback modes ( 80).
- If the camera is turned off, hold down the  button to turn the camera on in playback mode.

Shutter-release Button

The camera features a two-stage shutter-release button. To set focus and exposure, press the shutter-release button halfway, stopping when you feel resistance. Focus and exposure lock while the shutter-release button is held in this position. To release the shutter and take a picture, press the shutter-release button the rest of the way down. Do not use force when pressing the shutter-release button, as this may result in camera shake and blurred pictures.



Press the shutter-release button halfway to set focus and exposure

Press the shutter-release button the rest of the way down to take picture

Attaching the Camera Strap

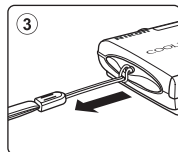
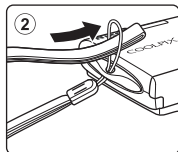
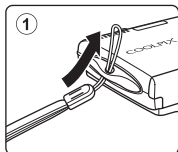

Operating the Touch Panel

The monitor on the COOLPIX S4000 is a touch panel display. Use a finger or the supplied stylus to operate the touch panel.

Tapping

Tap the touch panel.

Use this operation to:

Select icons or other controls

Select pictures in thumbnail playback mode (📖 77)

Perform touch shutter (📖 34), touch AF/AE (📖 37), or subject tracking (📖 40) operations

Start/end recording movies (📖 119)

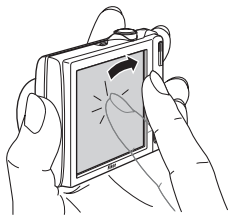

Dragging

Drag your finger across the touch panel.

Use this operation to:

Scroll through pictures in full-frame playback mode (📖 32)

Move the visible portion of a picture enlarged with playback zoom (📖 79)

Use sliders to adjust exposure compensation (📖 52) or other settings

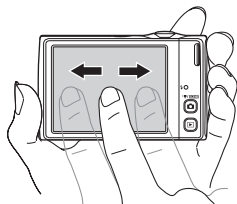

Using the Stylus

Use the stylus for operations, such as when using the paint option (📖 107) or the draw option (📖 69), that require more precision than using a finger is possible.

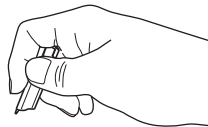

Attaching the Stylus

Attach the stylus to the strap as shown.

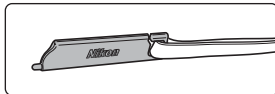

✔ Notes on the Touch Panel

- Do not press on the touch panel with pointed objects other than the supplied stylus.
- Do not apply unnecessary pressure to the touch panel.

✔ Notes on Tapping/Dragging

- The camera may not respond if your finger is left in one place too long.
- The camera may not respond if the followings are made.
 - Bounce your finger off the display
 - Drag your finger over too short a distance
 - Stroke the display too lightly
 - Move your finger too quickly

✔ Notes on the Touch Panel

- Keep the stylus out of reach of small children.
- Do not carry the camera by the stylus. The stylus may slip off the strap and the camera may fall.

Main Display of the Monitor/Touch Panel and Basic Operations

Shooting (Operation Controls)

Tap the following controls to change settings.

- The controls available and indicators displayed vary with information display on/off, shooting mode and the current camera settings.

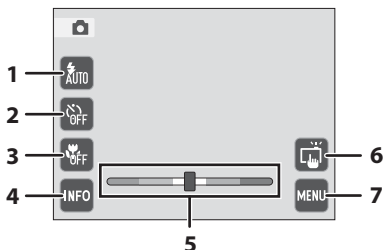

1		Flash mode 42
2		Self-timer 44
3		Macro mode 45
4		Information display setting

5	Hue adjustment (in Food scene mode) 66
6	Touch shooting
	Touch shutter 34
	Touch AF/AE 37
	Subject tracking 40
7	Touch AF/AE cancellation 37
	Menu 14

Information Display Setting

Tap to toggle the information display on and off in the following order. Monitor displays with the information display on are used for explanation purposes in this manual.

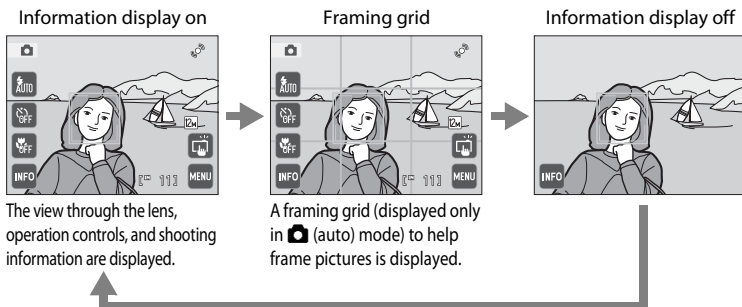

Shooting (Other Indicators)

The following monitor display shows the current settings applied from the shooting menu (📖 47) as well as the active focus area.

- The indicators displayed vary with current camera settings and shooting mode.

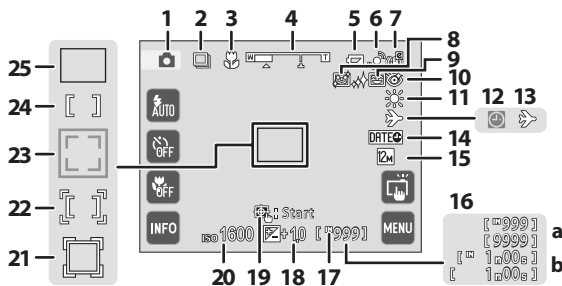

1	Shooting mode*26, 59, 72, 119
2	Continuous shooting mode, BSS 53
3	Macro mode45
4	Zoom indicator 29, 45
5	Battery level indicator 26
6	Motion detection146
7	Electronic VR icon 145
8	Skin softening74
9	Smile timer74
10	Blink proof 74
11	White balance mode 50
12	"Date not set" indicator 163
13	Travel destination icon 141

14	Date imprint 144
15	Image mode48
	Movie options 121
16	a Number of exposures remaining (still pictures)26
	b Movie length 119
17	Internal memory indicator27
18	Exposure compensation value52
19	Subject tracking start indicator40
20	ISO sensitivity43, 54
21	Focus area (subject tracking mode)40
22	Focus area (touch AF/AE)37
23	Focus area (face priority)30, 55
24	Focus area (center)55
25	Focus area (auto)30, 55

* Indicators displayed vary with current shooting mode.

Playback (Operation Controls)

Tap the following controls to switch between monitor displays, or delete or edit pictures.

- The controls available and indicators displayed vary with information display on/off, the picture played back and the current camera settings.

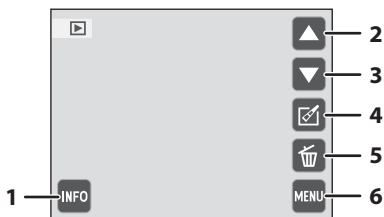

1	INFO	Information display setting
2	▲	Display previous picture..... 32
	▶	Volume 104, 123
3	▼	Display subsequent picture..... 32

	☑	Editing (still pictures) 81, 102, 103, 105
4	✂	Crop..... 118
	▶	Movie playback 123
5	🗑	Delete..... 33
6	MENU	Menu..... 14

Information Display Setting

Tap **INFO** to toggle the information display on and off in the following order. Monitor displays with the information display on are used for explanation purposes in this manual.

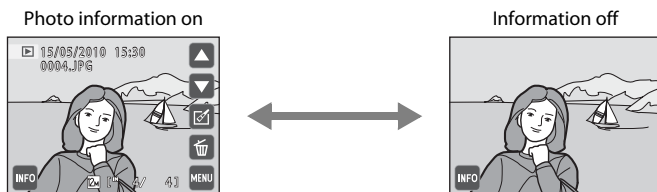

Picture, operation controls, and photo information are displayed.

Playback (Information Display)

The following monitor display shows information for the picture currently displayed.

- The controls and indicators displayed vary depending upon the picture played back and the current camera settings.

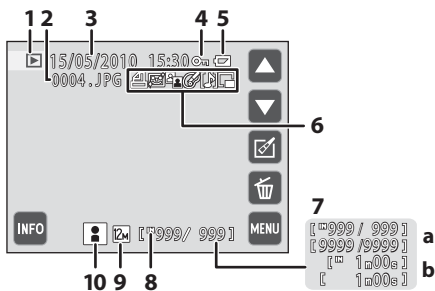

1	Playback mode ¹32, 81, 88, 91	7	a Current frame number/ total number of frames32
2	File number and type 162	7	b Movie length 123
3	Date/time of recording 22	8	IN Internal memory indicator 27
4	Protect icon 100	9	Image mode 48
5	Battery level indicator 26	10	Album icon in favorite pictures mode ² 83
6	Print-order icon 94	Category icon in auto sort mode ² 88	
	Skin softening icon 112		
	Quick retouch icon 110		
	D-Lighting icon 111		
	Paint icon 107		
10	Color options icon 117		
	Stretch icon 114		
	Perspective control icon 115		
	Voice memo icon 104		
	Small picture icon 116		

¹ Indicators displayed vary with current playback mode.

² The icon for the selected album or category in auto sort mode currently selected in playback mode is displayed.

The Menu Screen

Tap **MENU** to display the menu for the selected mode.

- Tap a tab at the top of the menu screen to switch to the menu for that tab.
- Tap **X** to exit the menu.

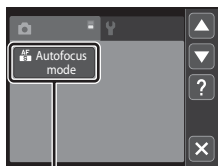
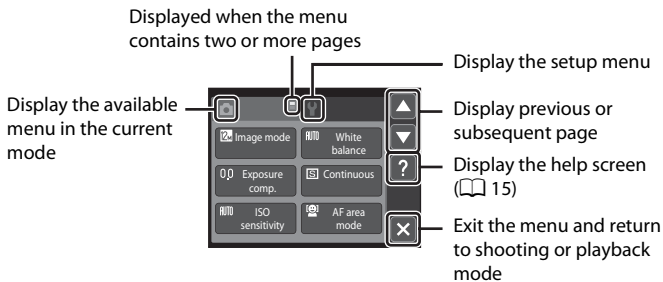

Tap the menu item to proceed to the next set of options

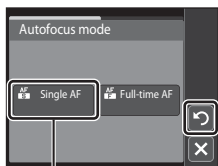

Tap the option to apply the selection

Return to the previous screen

Help Display

Tap the control when **?** is displayed in the monitor to display the help selection screen. Tap a menu item or option to view a description of that feature or setting. Tap **?** to return to the previous screen.

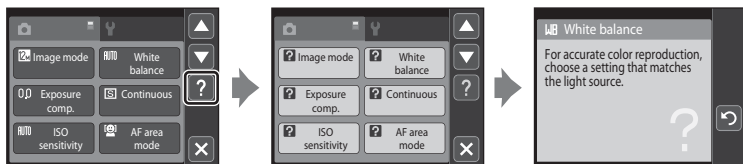

Inserting the Battery

Insert a Rechargeable Li-ion Battery EN-EL10 (supplied) into the camera.

- Charge the battery before the first use or when the battery is running low (📖 18).

- 1 Open the battery-chamber/memory card slot cover.

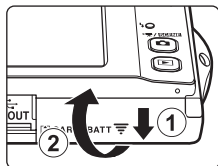

- 2 Insert the battery.

Confirm that the positive (+) and negative (-) terminals are oriented correctly as shown on the label at the battery chamber opening, and insert the battery.

Use the battery to push the orange battery latch up (①) as the battery is inserted (②).

When the battery is fully inserted, the battery latch will lock it in place.

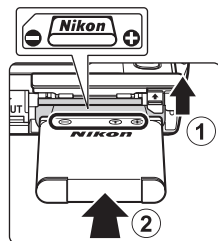

❑ Inserting the Battery

Inserting the battery upside down or backwards could damage the camera. Be sure to check that the battery is in the correct orientation.

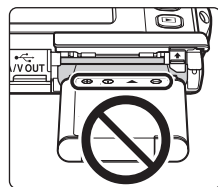

- 3 Close the battery-chamber/memory card slot cover.

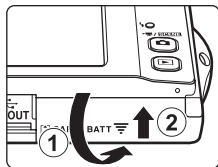

Removing the Battery

Turn the camera off (📖 21) and make sure that the power-on lamp and the monitor have turned off before opening the battery-chamber/memory card slot cover.

To eject the battery, open the battery-chamber/memory card slot cover and slide the orange battery latch in the direction indicated by the arrow (①). The battery can then be removed by hand (②).

- Note that the battery may become hot during use; observe due caution when removing the battery.

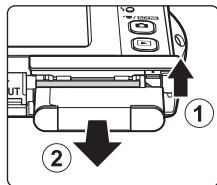

✓ Notes on the Battery

- Be sure to read and follow the warnings for the battery on page iii and the section, “The Battery” (📖 158), before using the battery.
- If the battery is not used for an extended period, recharge it at least once every six months and run it flat before returning it to storage.

Charging the Battery

Charge the supplied Rechargeable Li-ion Battery EN-EL10 inserted into the camera, by connecting the supplied Charging AC Adapter EH-68P to the camera via the supplied USB Cable UC-E6, and then plugging the Charging AC Adapter into an electrical outlet.

1 Prepare the Charging AC Adapter EH-68P.

If a plug adapter* is included, attach the plug adapter to the plug on the Charging AC Adapter. Push the plug adapter firmly until it is securely held in place. Once the two are connected, attempting to forcibly remove the plug adapter could damage the product.

* The shape of the plug adapter varies according to the country or region in which the camera was purchased.

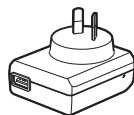
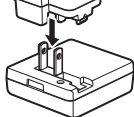
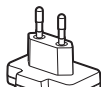
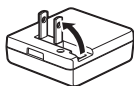

EH-68P (AR)

For Customers in Argentina

If the camera was purchased in Argentina, the shape of the Charging AC Adapter EH-68P (AR) differs from that supplied in other countries, and a plug adapter is not included. Proceed to step 2.

2 Be sure that the power-on lamp and the monitor are off.

Be sure to insert the battery into the camera (📖 16) and turn off the camera (📖 21).

3 Use the supplied USB cable to connect the Charging AC Adapter to the camera.

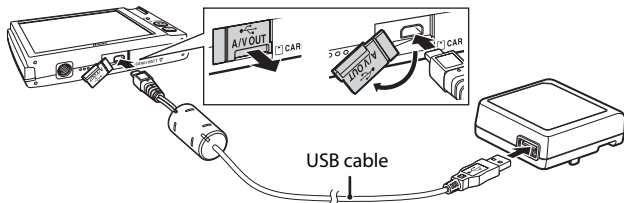

Connecting the Cable

When connecting the cable, be sure that the camera connector is properly oriented. Do not use force when connecting the cable to the camera. When disconnecting the cable, do not pull the connector at an angle.

4 Plug the Charging AC Adapter into an electrical outlet.

The charge lamp slowly blinks green to indicate that the battery is charging.

About two hours and ten minutes are required to charge a fully exhausted battery.

The following chart explains charge lamp status when the camera is plugged into the electrical outlet.

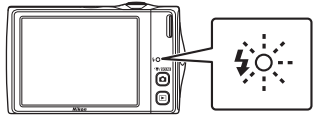
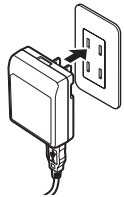

Charge lamp	Description
Blinks slowly (green)	Battery charging.
Off	Battery not charging. When charging is complete, the charge lamp stops blinking green and turns off.
Flickers (green)	<ul style="list-style-type: none"> The ambient temperature is not suited to charging. Charge the battery indoors with an ambient temperature of 5 °C to 35 °C (41 °F to 95 °F). The USB cable or Charging AC Adapter is not properly connected, or there is a problem with the battery. Disconnect the USB cable or unplug the Charging AC Adapter and correctly connect it again, or change the battery.

5 Disconnect the Charging AC Adapter from the electrical outlet and then disconnect the USB cable.

Charging the Battery

Notes on Charging AC Adapter

- The Charging AC Adapter EH-68P is for use only with compatible devices. Do not use with another make or model of device.
- Be sure to read and follow the warnings for the Charging AC Adapter on page iii and the section, "The Battery" (📖 158), before use.
- The Charging AC Adapter EH-68P can be used with AC power sources of 50/60 Hz and 100-240 V. To use the charging AC adapter abroad, be sure to use a power adapter (available commercially) where necessary. Check beforehand with your travel agent regarding the necessity for power adapter plugs.
- The Charging AC Adapter EH-68P is for charging the battery inserted into the camera. When the camera is connected to an electrical outlet with the Charging AC Adapter, the camera cannot be turned on.
- Do not, under any circumstances, use another make or model of AC adapter other than Charging AC Adapter EH-68P or USB-AC adapter. Failure to observe this precaution could result in overheating or in damage to the camera.

Note on AC Power Supply

- If the AC Adapter EH-62D (available separately; 📖 160) is used, power is supplied to the camera from an electrical outlet and taking pictures and playing back pictures are available with this camera.
- Do not, under any circumstances, use another make or model of AC adapter other than EH-62D. Failure to observe this precaution could result in overheating or in damage to the camera.

Charging Using Computer or Battery Charger



- Connecting the COOLPIX S4000 to a computer also charges the Rechargeable Li-ion Battery EN-EL10 (📖 126, 152).
- Rechargeable Li-ion Battery EN-EL10 can also be charged using the Battery Charger MH-63 (available separately; 📖 160).

Turning On and Off the Camera

To turn on the camera, press the power switch. The power-on lamp (green) will light for a moment and the monitor will turn on.

To turn off the camera, press the power switch again.

When the camera is turned off, both the power-on lamp and monitor will turn off.

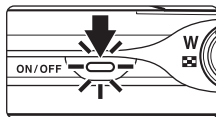

- If the camera is turned off, hold down the  button to turn the camera on in playback mode ( 33).





Power Saving Function (Auto Off)

If no operations are performed for a while, the monitor will turn off automatically, the camera will enter standby mode, and the power-on lamp will blink. If no operations are performed for another three minutes, the camera will turn off automatically.

- If no operations are performed for about a minute (default setting) in shooting or playback mode, the camera will enter standby mode.
- When the monitor has turned off in standby mode (the power-on lamp is blinking), press the following button to reactivate it.

Power switch, shutter-release button,  button, or  button

- The time allowed to elapse from before the camera enters standby mode can be changed from the **Auto off** option ( 149) in the setup menu ( 138).

Setting Display Language, Date and Time



A language-selection dialog is displayed the first time the camera is turned on.

1 Press the power switch to turn on the camera.

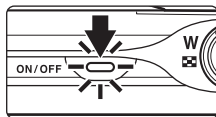
The power-on lamp (green) will light for a moment and the monitor will turn on.



2 Tap the desired language.

If the desired language is not displayed, tap  or  to view other language options.

For more information about operating the touch panel, see "Operating the Touch Panel" (📖 8).



3 Tap **Yes**.

If **No** is tapped, the date and time will not be set.

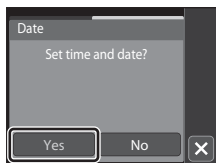



4 Tap or to select your home time zone (📖 143) and tap **OK**.



Daylight Saving Time

If daylight saving time is in effect, tap  in the time zone selection screen displayed in step 4 to turn on the daylight saving time option.

When the daylight saving time option is enabled,  is displayed at the top of the monitor. To turn off the daylight saving time option, tap  again.



- 5** Tap ▲ or ▼ to choose the order in which the day, month and year are displayed.

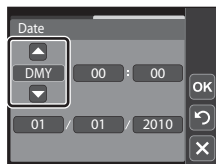

- 6** Edit the date and time.

Tap the desired item and ▲ or ▼ to edit the highlighted item.

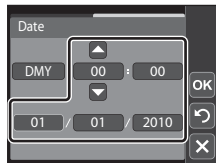

- 7** Tap **OK**.

The settings are applied and monitor display exits to shooting mode.

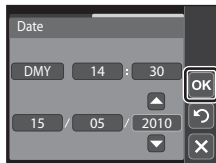

Changing and Imprinting the Date and Time

- Select **Date** from the **Date** item (📖 141) in the setup menu (📖 138) to change the current date and time and follow the procedure described in step 5 above.
- Select **Time zone** from the **Date** item (📖 141) in the setup menu to change the time zone and daylight saving time settings.
- To imprint the date on pictures, enable date imprint from the **Date imprint** option (📖 144) in the setup menu after the date and time have been set.

Inserting Memory Cards

Image, sound, and movie files are stored in the camera's internal memory (approximately 45 MB) or on removable Secure Digital (SD) memory cards (available commercially;  161).

If a memory card is inserted in the camera, data are automatically stored on the memory card and data recorded to the memory card can be played back, deleted or transferred. Remove the memory card to store data in the internal memory, or play back, delete or transfer data from the internal memory.

- 1 Be sure that the power-on lamp and the monitor are off and open the battery-chamber/memory card slot cover.

Be sure to turn off the camera before opening the battery-chamber/memory card slot cover.

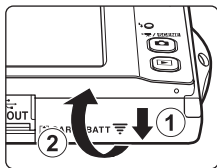

- 2 Insert the memory card.

Slide the memory card in correctly until it clicks into place.

Close the battery-chamber/memory card slot cover.

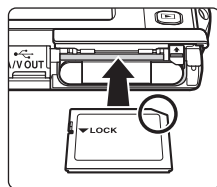

Inserting Memory Cards

Inserting the memory card upside down or backwards could damage the camera or the memory card. Be sure to check that the memory card is in the correct orientation.

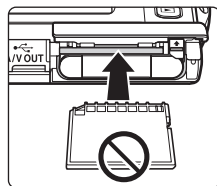

Removing Memory Cards

Before removing memory cards, turn the camera off and confirm that the power-on lamp and monitor are off. Open the battery-chamber/memory card slot cover and press the card in (1) to partially eject the card. The card can then be removed by hand. Do not attempt to remove the card at an angle (2).

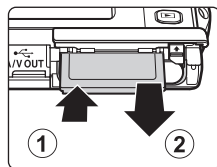

✓ Formatting Memory Cards

If the message at right is displayed when the camera is turned on, the memory card must be formatted before use (📖 150). Note that **formatting permanently deletes all pictures and other data on the memory card**. Be sure to make copies of any pictures you wish to keep before formatting the memory card.

Tap **Yes** to format. When the confirmation dialog is displayed, tap **Yes**. To start formatting, tap **OK**.

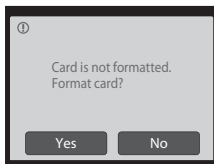

- Do not turn the camera off or open the battery-chamber/memory card slot cover until formatting is complete.
- Be sure to use this camera to format memory cards previously used in other devices the first time they are inserted into the COOLPIX S4000 (📖 150).

✓ The Write Protect Switch

Memory cards are equipped with a write protect switch. When this switch is in the “lock” position, data cannot be written to, or deleted from, the memory card. If the switch is in the “lock” position, unlock it by sliding the switch to the “write” position to record or delete pictures, or to format the memory card.

Write protect switch

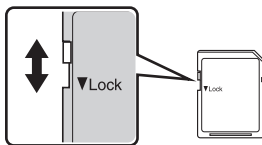

✓ Memory Cards

- Use only Secure Digital memory cards.
- Do not perform the following during formatting, while data is being written to or deleted from the memory card, or during data transfer to a computer. Failure to observe this precaution could result in the loss of data or in damage to the camera or memory card:
 - Take out the battery or memory card
 - Turn off the camera
 - Disconnect the AC adapter
- Do not format the memory card using a computer.
- Do not disassemble or modify.
- Do not drop, bend, or expose to water or strong physical shock.
- Do not touch the metal terminals with your fingers or metal objects.
- Do not affix labels or stickers to the memory card.
- Do not leave in direct sunlight, closed vehicles or areas exposed to high temperatures.
- Do not expose to humidity, dust, or corrosive gases.

Step 1 Turn the Camera On and Select (Auto) Mode

This section describes how to take pictures in  (auto) mode, an automatic, “point-and-shoot” mode recommended for first-time users of digital cameras.

1 Press the power switch to turn on the camera.

The power-on lamp (green) will light for a moment and the monitor will turn on. The lens will also extend.

Proceed to step 4 when  is displayed.

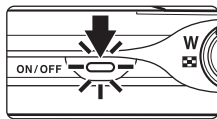

2 Press the button to display the shooting-mode selection menu.

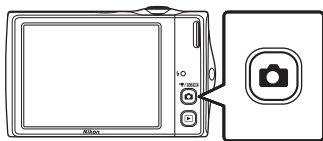

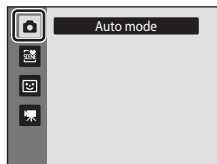

3 Tap in the monitor.

The camera enters  (auto) mode.



4 Check the battery level and the number of exposures remaining.

Battery Level

Monitor	Description
NO INDICATOR	Battery fully charged.
	Battery low. Prepare to charge or replace the battery.
 Battery exhausted.	Cannot take pictures. Recharge or replace with a fully charged battery.

Battery level indicator

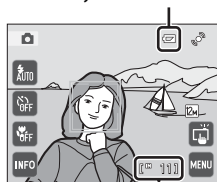



Number of exposures remaining

Number of Exposures Remaining

The number of pictures that can be stored depends on the capacity of the internal memory or memory card and image mode setting (📖 49).

Indicators Displayed in (Auto) Mode

Shooting mode

 displayed in  (auto) mode.

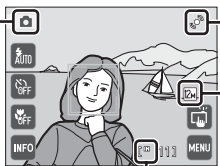

Motion detection icon

The effects of subject movement and camera shake are reduced.

Internal memory indicator

Indicates that images will be stored in the camera's internal memory (approximately 45 MB).







When a memory card is inserted in the camera,  does not appear and images will be stored on the memory card.

Image mode









The combination of image quality (compression) and image size is displayed. The default setting is  4000×3000.

- Tap  to change the information displayed in the monitor ( 10).
- When the monitor has turned off in standby mode to save power, press the following button to reactivate it ( 149).
 - Power switch, the shutter-release button, or  button

Note on Touch Shutter

At the default setting, the shutter can be released by simply tapping a subject in the monitor ( 34). Take care that you do not release the shutter accidentally.







Functions Available in (Auto) Mode

- The touch shutter ( 34), touch AF/AE ( 37), or subject tracking ( 40) function can be enabled.
- The flash mode ( 42) can be adjusted, the self-timer ( 44) and macro mode ( 45) can be applied.
- Tapping  to specify settings for all shooting menu items ( 47) according to the shooting conditions.

Motion Detection

See **Motion detection** ( 146) in the setup menu ( 138) for more information.

Electronic Vibration Reduction

When the flash mode ( 42) is set to  (off) or  (slow sync) with **Electronic VR** ( 145) in the setup menu set to **Auto**, the  icon may be displayed in the monitor. When  is displayed, the effects of camera shake may be pronounced under the current shooting conditions. In these situations, the camera reduces the effects of camera shake in pictures before recording them.

Step 2 Frame a Picture

1 Ready the camera.

Hold the camera steadily in both hands, keeping your fingers and other objects away from the lens, flash, AF-assist illuminator, microphone, and speaker.

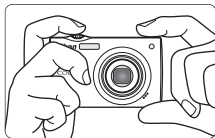

When taking pictures in portrait (“tall”) orientation, turn the camera so that the built-in flash is above the lens.

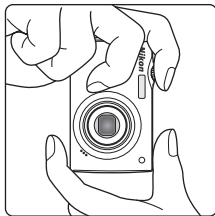

2 Frame the picture.

At the default settings, a face recognized by the camera will be framed by a yellow double border (focus area).

Up to 12 faces can be recognized. If more than one face is recognized, the face closest to the camera will be framed by a double border, and the others by a single border.

When taking pictures of subjects other than people, or framing a subject with which no face is recognized, a focus area will not be displayed. Frame the picture so that the intended subject is at or near the center of the frame.

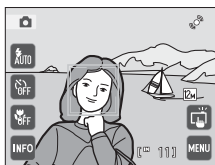

Using the Zoom

Use the zoom control to activate optical zoom. Rotate the zoom control to **T** to zoom in so that the subject fills a larger area of the frame, or **W** to zoom out, thus increasing the area visible in the frame.

A zoom indicator is displayed at the top of the monitor when the zoom control is rotated.

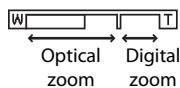
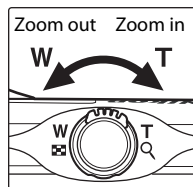

Digital Zoom

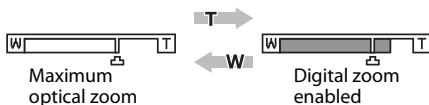

When the camera is zoomed in to the maximum optical zoom position, rotating and holding the zoom control at **T** triggers digital zoom. The subject is magnified up to 4× the maximum optical zoom ratio.

The camera focuses at the center of the frame and the focus area is not displayed when digital zoom is in effect.



Digital Zoom and Interpolation

Unlike optical zoom, digital zoom uses a digital imaging process known as interpolation to magnify images, resulting in slight deterioration of picture quality according to the image mode (📖 48) and digital zoom magnification.

Interpolation is applied at zoom positions beyond  when taking still pictures. When zoom is increased beyond the  position, interpolation is initiated and the zoom indicator turns yellow to indicate that interpolation is being applied. The position of  moves to the right as image size decreases, allowing for confirmation of the zoom positions at which shooting without interpolation is possible at the current image mode setting.

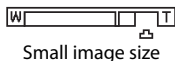

Digital zoom can be disabled from the **Digital zoom** option (📖 148) in the setup menu (📖 138).

Step 3 Focus and Shoot

1 Press the shutter-release button halfway.

Focus is locked when the shutter-release button is pressed halfway.

When a face is recognized, it is framed by the double border indicating the active focus area. When the subject is in focus, the double border turns green.

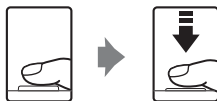

Shutter speed
Aperture

When a face is not recognized, camera automatically selects the focus area (up to nine areas) containing the subject closest to the camera. When the subject is in focus, the active focus area glows green.

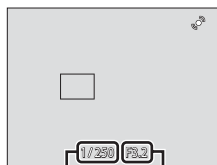

Shutter speed
Aperture

When digital zoom is used, the focus area is not displayed and the camera focuses at the center of the frame. Once focus has been acquired, the focus indicator will glow green.

When the shutter-release button is pressed halfway, the shutter speed and aperture value are also displayed.

Focus and exposure remain locked while the shutter-release button is pressed halfway.

While the shutter-release button is pressed halfway, the focus area or focus indicator may blink red. This indicates that the camera is unable to focus. Modify the composition and press the shutter-release button halfway again.

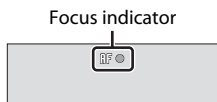

Focus indicator

2 Press the shutter-release button the rest of the way down.

The shutter is released and the picture will be recorded to the memory card or internal memory.



✔ During Recording

While pictures are being recorded, the number of exposures remaining will blink. **Do not open the battery-chamber/memory card slot cover** while pictures are being recorded. Cutting power or removing the memory card in these circumstances could result in loss of data or in damage to the camera or card.

✔ Autofocus

Autofocus may not perform as expected in the following situations. In some rare cases, the subject may not be in focus despite the fact that the focus area or the focus indicator glows green.

- Subject is very dark
- Objects of sharply differing brightness are included in the frame (e.g. the sun behind the subject makes that subject appear very dark)
- No contrast between the subject and surroundings (e.g. a portrait subject, wearing a white shirt, is standing in front a white wall)
- Several objects are at different distances from the camera (e.g. the subject is inside a cage)
- Subject is moving rapidly

In the situations noted above, try pressing the shutter-release button halfway to refocus several times, or focus on another subject (📖 39). When focusing on another subject, be sure that the alternate subject is at the same distance from the camera as the intended subject while the shutter-release button is pressed halfway.

✔ Note on Face Priority

See **AF area mode** (📖 55) or **Face priority** (📖 56) for more information.

📎 Touch Shutter

At the default setting, the shutter can be released by simply tapping a subject in the monitor (📖 34) rather than by pressing the shutter-release button. The Touch shutter option can be changed to the **Touch AF/AE** option, with which the camera locks focus and exposure without releasing the shutter, when a subject is tapped (📖 37).

📎 Blink Warning screen

When the camera detects that portrait subjects may have blinked when a picture was taken in face priority mode with 📷 **Blink warning** set to **On**, the blink warning screen (📖 153) is displayed in the monitor.

📎 AF-assist Illuminator and Flash

If the subject is poorly lit, the AF-assist illuminator (📖 147) may light when the shutter-release button is pressed halfway, or the flash (📖 42) may fire when the shutter-release button is pressed all the way down.



Step 4 Playing Back and Deleting Pictures

Playing Back Pictures (Playback Mode)

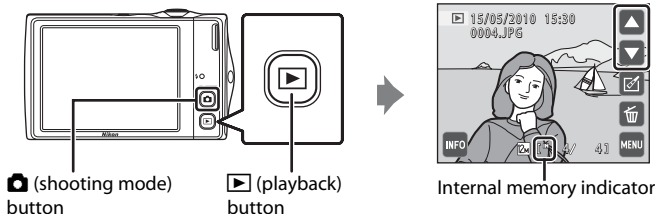
Press the  (playback) button



The last picture taken will be displayed in full-frame playback mode.

Drag the current picture left or right to display the previous or subsequent picture. Previous or subsequent pictures can also be viewed by tapping  or .

Drag your finger quickly across half of the monitor or more to skip past the previous or subsequent five pictures. Tap the monitor to stop at a picture as it slides past.

Display the previous picture

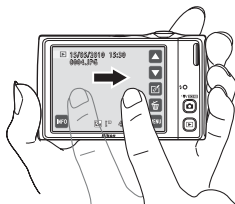

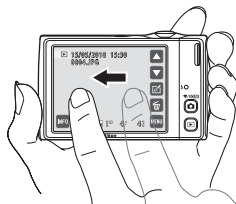

Display the subsequent picture



Pictures may be displayed briefly at low resolution while being read from the memory card or internal memory.

Press the  button or the shutter-release button to switch to shooting mode.

When playing back pictures stored in the camera's internal memory,  is displayed. When a memory card is inserted in the camera,  is not displayed and images stored on the memory card are played back.

Tap  to toggle displayed operation controls and information display on and off ( 12).

Deleting Pictures

- 1 Tap  to delete the picture currently displayed in the monitor.

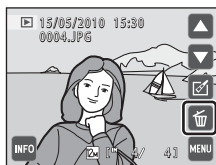

- 2 Tap **Yes**.

Deleted pictures cannot be recovered.

To exit without deleting the picture, tap **No**.



Operations Available in Playback Mode

See "More on Playback" (📖 75) or "Editing Pictures" (📖 105) for more information.

Pressing the Button to Turn On the Camera

When the camera is off, holding down the  button will turn the camera on in playback mode. The lens will not extend.

Viewing Pictures

- When pictures in which a face was recognized during shooting (📖 56) are displayed in full-frame playback mode, depending upon the orientation of the recognized face, the pictures may be automatically rotated for playback display (excluding pictures that were shot using **Continuous**, **BSS** and **Multi-shot 16**; 📖 53).
- When the monitor has turned off in standby mode to save power, press the following button to reactivate it (📖 149).
 - The power switch, shutter-release button, or  button

Deleting Multiple Pictures

Multiple pictures can be deleted from the **Delete** option (📖 98) in the playback menu (📖 93), the favorite pictures menu (📖 85), the auto sort menu (📖 90), or the list by date menu (📖 92).

Tapping the Monitor to Release the Shutter (Touch Shutter)

Pictures can be taken by simply tapping the monitor.

- When  (default setting) is displayed for the touch shooting indicator, proceed to step 3.

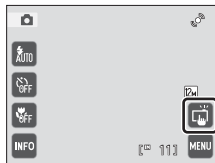

1 Tap the touch shooting icon.

The touch shooting menu is displayed in the monitor.

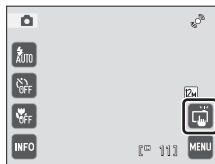

2 Tap (Touch shutter).

 is displayed at right in the monitor in shooting mode.

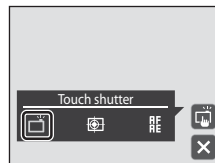



3 Tap the desired subject to take a picture.

Do not use force when tapping the monitor as this may cause slight movement of the camera, resulting in blurred pictures.

When digital zoom is in effect, the camera focuses at the center of the frame.

The shutter-release button can also be used when the touch shutter option is selected.

If  is displayed when the monitor is tapped, the shutter cannot be released. Tap an area within  or a border displayed when the camera recognizes a face.

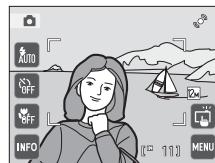
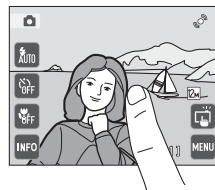

✓ Notes on Touch Shutter

- When taking pictures with **Continuous** or **BSS** in **Continuous** setting (📖 53) enabled, or in **Sports** or **Museum** scene mode (📖 59), use the shutter-release button to take pictures. Only one picture can be taken at a time using the touch shutter function.
- Prevent shooting with accidental tapping of the monitor in 📷 (auto) mode and some scene modes by changing the touch shooting setting to **Touch AF/AE** (📖 37). At this setting, the shutter is not released when the monitor is tapped.
- In some rare cases, shooting subjects with which autofocus may not perform as expected, the subject may not be in focus (📖 31).
- When a subject displayed in the monitor is tapped with the self-timer (📖 44) enabled, the camera locks focus and releases the shutter after ten or two seconds.

✍ Shooting Modes That Support Touch Shutter

Touch shutter can be enabled in shooting modes other than 📷 (auto) mode as well. Touch shutter operation differs according to the current shooting mode as follows.



Shooting mode	Touch shutter operation
📷 (auto) mode (📖 26), Sports, Party/indoor, Beach/snow, Close-up, Food, Museum, Copy, and Backlight scene modes (📖 59)	Tap the intended subject. Focus and exposure are set for the area tapped. When the camera recognizes more than one face, tap a face framed by a single border to set focus and exposure for that face.
Scene auto selector scene mode (📖 59) and smart portrait mode (when Smile timer is set to Off ; 📖 72)	<ul style="list-style-type: none"> • When the camera recognizes a face, focus and exposure are set for the area framed by the double border. When the camera recognizes more than one face, tap a face framed by a single border to set focus and exposure for that face. • When no face is recognized, the camera focuses at the area tapped.
Portrait and Night portrait scene modes (📖 59)	Only a border displayed by the face priority function can be selected. When the camera recognizes more than one face, tap a face framed by a single border to set focus and exposure for that face.
Landscape, Sunset, Dusk/dawn, Night landscape, Fireworks show, and Panorama assist scene modes (📖 59)	Focus and exposure are set for the same focus area used when pictures are taken by pressing the shutter-release button. See “Selecting a Scene Mode to Take Pictures (Features)” (📖 62) for more information.
Smart portrait mode (when Smile timer set to On ; 📖 72)	Touch shutter cannot be enabled. When the camera recognizes more than one face, tap a face framed by a single border to move the focus area to that face.

Tapping the Monitor to Release the Shutter (Touch Shutter)

Touch Shutter Function When Recording Movies

Touch shutter is also available for movie recording. Movie recording can be initiated or stopped by tapping the monitor ( 119).

Touch Shooting Setting

The touch shooting setting applied in  (auto) mode is stored in the camera's memory even after the camera is turned off, and reapplied the next time  (auto) mode is selected.

Tapping the Monitor to Focus (Touch AF/AE)

The touch shooting setting can be changed from **Touch shutter** (default setting) to **Touch AF/AE**.

Tap a subject in the monitor to select the area at which the camera focuses. Press the shutter-release button halfway to lock focus and exposure for the area tapped, and press the shutter-release button the rest of the way down to take the picture.

1 Tap the touch shooting control.

The menu of the touch shooting setting is displayed in the monitor.



2 Tap **AF/AE** (Touch AF/AE).

AF/AE is displayed at right in the monitor in shooting mode.

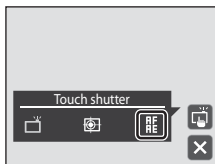

3 Tap the subject at which the camera focuses.

AF or a double border will be displayed at the area tapped.

When digital zoom is applied, the focus area cannot be selected.

To disable the focus area selection, tap **INFO OFF** displayed at right in the monitor.

If a position at which focus cannot be acquired is tapped, **AF** will be displayed in the monitor. Tap another position inside **AF**.

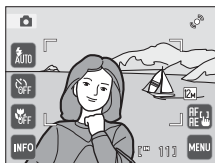
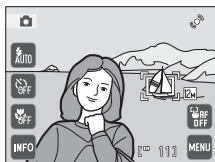

4 Press the shutter-release button to take a picture.

Press the shutter-release button halfway to acquire focus and exposure and press it all the way down to release the shutter.



Note on Touch AF/AE



In some rare cases, shooting subjects with which autofocus may not perform as expected, the subject may not be in focus (📖 31).

Shooting Modes That Enable Touch AF/AE Function

Touch AF/AE can be enabled in shooting modes other than  (auto) mode as well. Touch AF/AE operation differs according to the current shooting mode as follows.



Shooting mode	Touch AF/AE operation
 (auto) mode (📖 26), Sports, Party/indoor, Beach/snow, Close-up, Food, Museum, Copy, and Backlight scene modes (📖 59)	Focus and exposure are set for the area tapped.
Scene auto selector scene mode (📖 59) and smart portrait mode (when Smile timer is set to Off ; 📖 72)	<ul style="list-style-type: none"> When the camera recognizes a face, only a face framed by a border can be selected. When the camera recognizes more than one face, tap a face framed by a single border to move the focus area to that face. When no face is recognized, the camera focuses at the area tapped.
Portrait and Night portrait scene modes (📖 59), smart portrait mode (when Smile timer is set to On ; 📖 72)	Only a border displayed by the face priority function can be selected. When the camera recognizes more than one face, tap a face framed by a single border to move the focus area to that face.
Landscape, Sunset, Dusk/dawn, Night landscape, Fireworks show, and Panorama assist scene modes (📖 59)	Focus area cannot be changed.

Touch Shooting Setting

The touch shooting setting applied in  (auto) mode is stored in the camera's memory even after the camera is turned off, and reapplied the next time  (auto) mode is selected.



Taking Pictures of Subjects with Which Autofocus may not Perform as Expected

When taking pictures of subjects with which autofocus may not perform as expected (📖 31), try pressing the shutter-release button halfway to refocus several times, or try the following techniques.

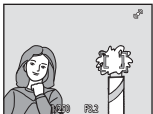
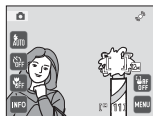
- Switch to  (auto) mode and select **Touch AF/AE** for the touch shooting setting.
 -  is displayed at right in the monitor in shooting mode.
- Tap another subject that is as far from the camera as the desired subject.
- Press the shutter-release button halfway.
 - Confirm that the focus area glows green.
 - Exposure is locked for the subject on which focus is acquired when the shutter-release button is pressed halfway.
- Continue holding down the shutter-release button halfway and recompose the picture.
 - Be sure to maintain the same distance between the camera and the subject while the shutter-release button is pressed halfway.
- Press the shutter-release button the rest of the way down to take the picture.



Focusing on a Moving Subject (Subject Tracking)

In  (auto) mode ( 26), the touch shooting setting can be changed from **Touch shutter** (default setting) to **Subject tracking**. Use this option to take pictures of moving subjects. Tap the subject on which the camera will focus. The focus area will automatically move to track the subject.

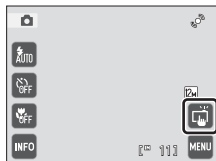

1 Tap the touch shooting control.

The menu of the touch shooting setting is displayed in the monitor.



2 Tap (Subject tracking).

 is displayed at right in the monitor in shooting mode.

 (subject tracking) is not enabled in shooting modes other than  (auto) mode.

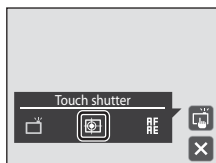



3 Select a subject.

Tap the desired tracking subject in the monitor.

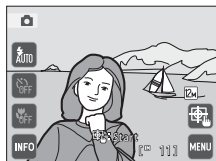
- The subject is selected.
- When the border framing the subject glows red, the camera is unable to focus. Change the composition and try again.



If an area that does not contain a selectable subject is tapped,  will be displayed in the monitor. Tap a subject within .

When the subject is selected, a yellow focus area is displayed around that subject and the camera begins tracking the subject.

Tap another subject to change a subject to follow.

To deselect the subject, tap  displayed at right in the monitor.

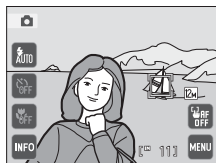

If the camera cannot track the selected subject anymore, the focus area will disappear and the selection will be canceled. Select the subject again.

4 Press the shutter-release button to take a picture.

The camera focuses on the focus area when the shutter-release button is pressed halfway. The focus area will glow green and focus will be locked.

When the camera is unable to focus, the focus area will blink. Press the shutter-release button halfway again to focus.

If the shutter-release button is pressed halfway while the focus area is not displayed, focus is set at the center of the frame.

Press the shutter-release button all the way down to release the shutter.



✓ Notes on Subject Tracking Mode

- Digital zoom is not available.
- Adjust zoom position and apply flash or menu settings before selecting the subject. If these settings are adjusted after the subject has been selected, subject selection will be canceled.
- It may be impossible to select the desired subject, or the camera may be unable to track the selected subject or may begin tracking a different subject, if the subject is moving rapidly, if there is a significant amount of camera shake, or if the camera recognizes a similar subject. The camera's ability to accurately track the selected subject is also dependent upon the size and brightness of the subject.
- In some rare cases, subjects with which autofocus may not perform as expected (📖 31) may be out of focus despite the fact that the focus area glows green. In this situation, focus on another subject which is at the same distance from the camera as the intended subject while the shutter-release button is pressed halfway (📖 39).
- There may be functions with which this setting cannot be enabled. See "Camera Settings that Cannot Be Applied Simultaneously" (📖 58) for more information.

✍ Functions That is available in Subject Tracking Mode

- Flash mode (📖 42) can be changed.
- Self-timer (📖 44), and macro mode (📖 45) is not available.

✍ Touch Shooting Setting

- The touch shooting setting applied in 📷 (auto) mode is stored in the camera's memory even after the camera is turned off, and reapplied the next time 📷 (auto) mode is selected.
- Subject selection with subject tracking will be canceled when the camera is turned off.

Using the Flash

When **ISO sensitivity** is set to **Auto**, the flash has a range of 0.5–4.5 m (1 ft. 8 in.–14 ft.) at the maximum wide-angle zoom position and a range of 0.5–2.4 m (1 ft. 8 in.–7 ft. 10 in.) at the maximum telephoto zoom position. The following flash modes are available.



Auto

Flash fires automatically when lighting is poor.



Auto with red-eye reduction

Reduce “red-eye” in portraits (📖 43).



Off

Flash will not fire even when lighting is poor.



Fill flash

Flash fires whenever a picture is taken. Use to “fill-in” (illuminate) shadows and backlit subjects.



Slow sync

AUTO (auto) is combined with slow shutter speed.

Suited to evening and night portraits that include background scenery. Flash illuminates main subject; slow shutter speeds are used to capture background at night or under dim lighting.

Setting the Flash Mode

1 Tap the flash mode control.

The flash mode menu is displayed.

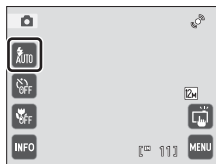

2 Tap the desired flash mode control.

The icon for the selected flash mode is displayed at the top of the monitor.

When is tapped, the menu will close and the monitor display will return to shooting mode without changing the flash mode.

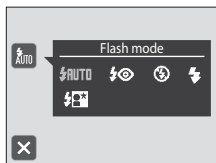

✓ Shooting When the Flash Is Disabled (🚫) or Lighting Is Dim

- Use of a tripod is recommended to stabilize the camera during shooting and avoid the effects of camera shake.
- The **ISO** indicator is displayed when the camera automatically increases sensitivity. Pictures taken when **ISO** is displayed may be slightly mottled.
- The noise reduction function may be activated with some shooting conditions such as dim lighting. More time than usual is required to record pictures to which noise reduction is applied.

✓ Note on Using the Flash

When using the flash, reflections from dust particles in the air may appear as bright spots in pictures. To reduce these reflections, set the flash to 🚫 (off).

✍ The Flash Lamp

The flash lamp indicates flash status when the shutter-release button is pressed halfway.

- On: Flash will fire when picture is taken.
- Blinks: Flash charging. Wait a few seconds and try again.
- Off: Flash will not fire when picture is taken.

If the battery is low, the monitor display will turn off, and remain off, until the flash is fully charged.

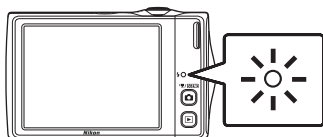

✍ The Flash Mode Setting

The default flash mode setting varies with shooting mode.

- 📷 (auto) mode: **🚫** (auto)
- Scene: varies with the selected scene mode (📖 62)
- 📷 (smart portrait): fixed at **🚫** (auto) when **Off** is selected for **Blink proof**; 🚫 (off) when **On** is selected for **Blink proof** (📖 74)

There may be functions with which the flash cannot be enabled. See “Camera Settings that Cannot Be Applied Simultaneously” (📖 58) for more information.

The flash mode setting applied in 📷 (auto) mode is stored in the camera’s memory even after the camera is turned off, and reapplied the next time 📷 (auto) mode is selected.

✍ Red-eye Reduction

This camera uses advanced red-eye reduction (“In-Camera Red-Eye Fix”).

If the camera detects “red eye” while a picture is being recorded, the affected area will be processed to reduce red-eye before the picture is saved. Note the followings when shooting.

- More time than usual is required to record pictures.
- Red-eye reduction may not produce the desired results in all situations.
- In extremely rare instances, areas not subject to red-eye may be affected by red-eye reduction processing; in these cases, choose another flash mode and try again.

Taking Pictures with the Self-timer

The camera is equipped with a ten-second and two-second timer for self-portraits. This feature is useful for reducing the effects of camera shake that occurs when pressing the shutter-release button. When using the self-timer, use of a tripod is recommended.

1 Tap the self-timer control.

The self-timer menu is displayed.

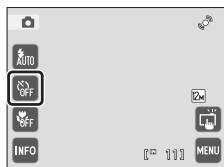

2 Tap 10s or 2s.

10s (ten seconds): Use on important occasions, such as weddings

2s (two seconds): Use to prevent camera shake

The selected self-timer mode is displayed.

Tap **X** to close the menu and return to shooting mode without changing the self-timer setting.



3 Frame the picture and press the shutter-release button halfway.

Focus and exposure will be set.

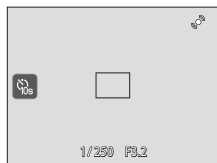

4 Press the shutter-release button the rest of the way down.

The self-timer starts, and the number of seconds remaining before the shutter is released is displayed in the monitor. The self-timer lamp blinks while the timer is counting down. About one second before the shutter is released, the lamp stops blinking and glows steadily.

When the shutter is released, the self-timer will be set to **OFF**.

To stop the timer before a picture is taken, press the shutter-release button again.

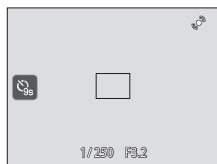

Macro Mode

Macro mode is used for taking pictures of objects as close as 8 cm (3.2 in.). Note that the flash may be unable to light the entire subject at distances of less than 50 cm (1 ft. 8 in.).

1 Tap the macro mode control.

The macro mode menu is displayed.

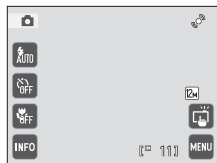



2 Tap ON.

The macro mode icon (🌸) is displayed.

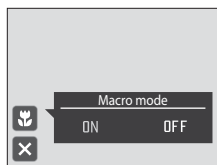
When **ON** is tapped, the menu will close and the monitor display will return to shooting mode without changing the macro mode setting.





3 Rotate the zoom control to frame the picture.

The closest distance at which the camera can focus varies depending on the zoom position. The camera can focus at the shortest distances when  and the zoom indicator glow green with the zoom indicator positioned to the left (wider angle) of .

At the zoom position one step to the right (telephoto) of the maximum wide-angle zoom position, the camera can focus on subjects as close as 8 cm (3.2 in.) to the lens. At the maximum wide-angle zoom position and  zoom position, the camera can focus at a distance of 20 cm (8 in.).





Autofocus





When using  (auto) mode, if **Autofocus mode** ( 57) is set to **Full-time AF**, the camera focuses continuously until focus is locked when the shutter-release button is pressed halfway. Therefore, the sound of lens drive movement can be heard.

When using other shooting modes of still pictures, **Full-time AF** is turned on automatically when macro mode is turned on.

The Macro Mode Setting

The macro mode setting applied in  (auto) mode is stored in the camera's memory even after the camera is turned off, and reapplied the next time  (auto) mode is selected.

Selecting a Shooting Mode

Select a shooting mode from  (auto),  (scene),  (smart portrait), and  (movie) modes.

1 Press the button in shooting mode.

The shooting mode-selection menu is displayed.

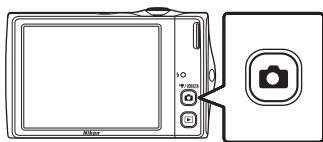

2 Tap the desired shooting mode control.

The camera enters the selected shooting mode.

If the scene mode control (second control from the top) was tapped, tap the desired scene mode icon ( 59).

To return to the current shooting mode without switching shooting modes, press the  button or the shutter-release button.

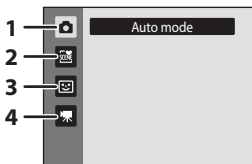

1 Auto mode

 26

Pictures can be taken with an automatic, "point-and-shoot" mode recommended for first-time users of digital cameras. The subject tracking setting can be applied. Shooting settings such as continuous shooting can be applied from the shooting menu ( 47).

2 Scene mode

 59

Camera settings are automatically optimized for the selected scene. In scene auto selector mode, the camera automatically selects the optimum scene mode for simpler shooting.

3 Smart portrait mode

 72

The camera uses face priority to recognize human faces, and then automatically releases the shutter when a smile is detected. The skin softening option can be used to make skin tones of human faces displayed smoothly.

4 Movie

 119

Movie (with sound) can be recorded.

Shooting Options: Shooting Menu (📷 (Auto) Mode)

The following options can be set when shooting in 📷 (auto) mode (📖 26).

Image mode	📖 48
Choose the image mode (combination of image size and compression rate) at which pictures are recorded. The image mode setting can also be modified from other shooting modes (except movie recording).	
White balance	📖 50
Match white balance to the light source.	
Exposure comp.	📖 52
Alter exposure to make pictures brighter or darker.	
Continuous	📖 53
Enable continuous shooting or BSS (best shot selector).	
ISO sensitivity	📖 54
Control the camera's sensitivity to light.	
AF area mode	📖 55
Choose how the camera selects the focus area.	
Autofocus mode	📖 57
Choose how the camera focuses.	

Displaying the Shooting Menu

Enter 📷 (auto) mode (📖 26).

Tap  to display the shooting menu.

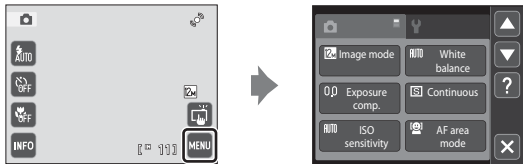

- Tap menu items to adjust settings.
- Tap  to exit the shooting menu.

Camera Settings That cannot be Applied Simultaneously

Some functions cannot be enabled in conjunction with others (📖 58).

Image Mode (Image Quality/Image Size)

📷 (auto) → **MENU** (Shooting menu) → Image mode

Image mode refers to the combination of image size and image quality (compression) at which pictures are recorded. Choose the image mode best suited to the manner in which pictures will be used and the capacity of the internal memory or memory card. The higher the image mode setting, the larger the size at which it can be printed or displayed without appearing noticeably “grainy,” but limiting the number of pictures that can be recorded.

Option	Size (pixels)	Description
12M 4000×3000★	4000 × 3000	Higher quality than 12M , suitable for enlargements or high-quality prints. The compression ratio is approximately 1:4.
12M 4000×3000 (default setting)	4000 × 3000	Best choice in most situations. The compression ratio is approximately 1:8.
8M 3264×2448	3264 × 2448	
5M 2592×1944	2592 × 1944	
3M 2048×1536	2048 × 1536	Smaller size than 12M , 8M , or 5M , allows more pictures to be stored. The compression ratio is approximately 1:8.
PC 1024×768	1024 × 768	Suited to display on a computer monitor. The compression ratio is approximately 1:8.
VGA 640×480	640 × 480	Suited to full-screen display on a television with an aspect ratio of 4:3, or distribution by e-mail. The compression ratio is approximately 1:8.
16:9 3968×2232	3968 × 2232	Pictures with an aspect ratio of 16:9 are taken. The compression ratio is approximately 1:8.









The icon for the current setting is displayed in the monitor in shooting and playback modes (📖 11, 13).

Image Mode

- Changes made to this setting apply to all shooting modes (except movie recording).
- There may be functions with which this setting cannot be enabled. See “Camera Settings that Cannot Be Applied Simultaneously” (📖 58) for more information.

Number of Exposures Remaining

The following table lists the approximate number of pictures that can be stored in internal memory and on a 4 GB memory card. Note that the number of pictures that can be stored will differ depending on the composition of the picture (due to JPEG compression). In addition, this number may vary depending on the make of memory card, even when the memory cards have the same specified capacity.

Setting	Internal memory (approx. 45 MB)	Memory card ¹ (4 GB)	Print size ² (cm/in.)
 4000×3000★	5	505	34 × 25/13 × 10
 4000×3000	11	1010	34 × 25/13 × 10
 3264×2448	17	1575	28 × 21/11 × 8
 2592×1944	28	2565	22 × 16/8.5 × 6.5
 2048×1536	46	4235	17 × 13/7 × 5
 1024×768	134	13500	9 × 7/3.5 × 2.5
 640×480	260	23000	5 × 4/2 × 1.5
 3968×2232	14	1370	34 × 19/13 × 7.5

¹ If the number of exposures remaining is 10,000 or more, the number of exposures remaining display shows “9999”.

² Print size at an output resolution of 300 dpi. Print sizes are calculated by dividing the number of pixels by printer resolution (dpi) and multiplying by 2.54 cm (1 in.). However, at the same image size, pictures printed at higher resolutions will print smaller than the size indicated, and those printed at lower resolutions will print larger than the size indicated.

White Balance (Adjusting Hue)

📷 (auto) → MENU (Shooting menu) → White balance

The color of light reflected from an object varies with the color of the light source. The human brain is able to adapt to changes in the color of the light source, with the result that white objects appear white whether seen in the shade, direct sunlight, or under incandescent lighting. Digital cameras can mimic this adjustment by processing images according to the color of the light source. This is known as “white balance.” For natural colors, choose a white balance setting that matches the light source before shooting. Although the default setting, **Auto**, can be used under most types of lighting, the white balance setting suited to a particular light source can be specified manually to achieve more accurate results.

AUTO Auto (default setting)

White balance automatically adjusted to suit lighting conditions. Best choice in most situations.

PRE Preset manual

Neutral-colored object used as reference to set white balance under unusual lighting conditions. See “Preset Manual” (📖 51) for more information.

☀️ Daylight

White balance adjusted for direct sunlight.

💡 Incandes.

Use under incandescent lighting.

💡 Fluorescent

Use under fluorescent lighting.

☁️ Cloudy

Use when taking pictures under overcast skies.

🔦 Flash

Use with the flash.

At settings other than **Auto**, the icon for the current setting is displayed in the monitor (📖 11).

✔️ Notes on White Balance

- There may be functions with which this setting cannot be enabled. See “Camera Settings that Cannot Be Applied Simultaneously” (📖 58) for more information.
- At white-balance settings other than **Auto** or **Flash**, turn the flash off (🔦) (📖 42).

Preset Manual

Preset manual is effective with mixed lighting or to compensate for light sources with a strong color cast (for example, to make pictures taken under a lamp with a red shade look as though they had been taken under white light).

- 1 Place a white or gray reference object under the lighting that will be used during shooting.

- 2 Display the shooting menu (📖 47), tap **White balance** to select **PRE Preset manual**, and tap **OK**.

The camera zooms in.

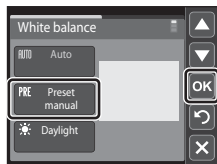

- 3 Frame the reference object in the measuring window.

To apply the most recently measured value for preset manual, tap **Cancel**.

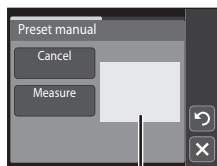

Measuring window

- 4 Tap **Measure** to measure a value for preset manual.

The shutter is released and the new white balance value is set. No picture is recorded.

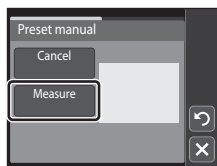

✔ Note on Preset Manual

A value for flash lighting cannot be measured with **Preset manual**. When shooting using the flash, set **White balance** to **Auto** or **Flash**.

Exposure Comp. (Adjusting Brightness)

📷 (auto) → MENU (Shooting menu) → Exposure comp.

Exposure compensation is used to alter exposure from the value suggested by the camera to make pictures brighter or darker.

- To make the picture brighter, tap ▶ to apply positive (+) exposure compensation, and tap OK.
- To make the picture darker, tap ◀ to apply negative (-) exposure compensation, and tap OK.
- Exposure compensation can also be applied or adjusted by dragging the slider.
- Exposure compensation can be set to values between -2.0 and +2.0 EV.
- When an exposure compensation value other than 0.0 is applied, the value is displayed with the ☒ icon in the monitor.
- To exit without setting the exposure compensation, set the value to 0.0 and tap OK.



Exposure Compensation Value

- Exposure compensation can be enabled in scene modes (except **Fireworks show** and **Draw** scene modes) and smart portrait mode.
- The exposure compensation value applied in 📷 (auto) mode is stored in the camera's memory even after the camera is turned off, and reapplied the next time 📷 (auto) mode is selected. The exposure compensation value applied in any scene mode or smart portrait mode reverts to 0.0 whenever another shooting mode is selected or the camera is turned off.

Using Exposure Compensation

The camera tends to reduce exposure when the frame is dominated by brightly lit objects and to increase exposure when the frame is mostly dark. Positive compensation may therefore be required to capture the brilliancy of very bright objects that fill the frame (for example, sunlit expanses of water, sand, or snow) or when the background is much brighter than the main subject. Negative compensation may be called for when large areas of the frame contain very dark objects (for example, a swath of dark green leaves) or when the background is much darker than the main subject.

Continuous

📷 (auto) → MENU (Shooting menu) → Continuous

Enable continuous shooting or BSS (best shot selector). The flash is disabled when **Continuous**, **BSS** or **Multi-shot 16** is selected, and focus, exposure and white balance are fixed at the values determined with the first picture in each series.

📷 Single (default setting)

One picture is taken each time the shutter-release button is pressed.

📷 Continuous

While the shutter-release button is held down, up to three pictures are taken at a rate of about 0.9 frames per second (at an **Image mode** setting of 📷 4000x3000).

BSS (Best Shot Selector)

The “best shot selector” is recommended when shooting with the flash off or the camera zoomed in, or in other situations in which inadvertent motion can result in blurred pictures. When BSS is on, the camera takes up to ten pictures while the shutter-release button is held down. The sharpest picture in the series is automatically selected and saved.

📷 Multi-shot 16

Each time the shutter-release button is pressed, the camera takes 16 shots at a rate of about 30 fps and arranges them in a single image.

Image mode is fixed at 📷 (image size: 2560 × 1920 pixels). Digital zoom is not available.



At settings other than **Single**, the indicator for the current setting is displayed in the monitor (📖 11).

✔ Notes on Continuous Shooting

- The frame rate with continuous shooting may vary depending upon the current image mode setting, the memory card used, or shooting condition.
- There may be functions with which this setting cannot be enabled. See “Camera Settings that Cannot Be Applied Simultaneously” (📖 58) for more information.

✔ Note on BSS

BSS is effective when taking pictures of still subjects. BSS may not produce the desired results if the subject moves or the composition changes while the shutter-release button is held down.

✔ Note on Multi-shot 16

Smear (📖 159) visible in the monitor when shooting with **Multi-shot 16** enabled will be recorded with images. Avoiding bright objects such as the sun, reflections of the sun, and electric lights when shooting with **Multi-shot 16** enabled is recommended.

ISO Sensitivity

📷 (auto) → MENU (Shooting menu) → ISO sensitivity

Sensitivity is a measure of the camera's response to light. The higher the sensitivity, the less light is needed to expose an image. Although high ISO sensitivity settings are suited to pictures of moving subjects or those taken under dim lighting, high sensitivity settings are often associated with "noise"—randomly spaced, brightly colored pixels—concentrated in dark portions of images.

Auto (default setting)

Sensitivity is ISO 80 under normal conditions; when lighting is poor, the camera compensates by raising sensitivity to a maximum of ISO 1600.

Fixed range auto

Choose the range in which the camera automatically adjusts ISO sensitivity, from **ISO 80-400** or **ISO 80-800**. The camera will not increase sensitivity beyond the maximum value in the selected range. Set the maximum value for ISO sensitivity for effective control over the amount of "grain" that appears in images.

80, 100, 200, 400, 800, 1600, 3200

Sensitivity is locked at the specified value.

At the settings other than **Auto**, the current setting is displayed in the monitor (📖 11). If **Auto** is selected and the sensitivity is raised above ISO 80, the **ISO** icon will be displayed (📖 43). When **Fixed range auto** is selected,  and the maximum value of ISO sensitivity is displayed.

✔ Notes on ISO Sensitivity

- There may be functions with which this setting cannot be enabled. See "Camera Settings that Cannot Be Applied Simultaneously" (📖 58) for more information.
- When the ISO sensitivity setting is set to any option other than **Auto**, **Motion detection** (📖 146) is disabled.

AF Area Mode

📷 (auto) → MENU (Shooting menu) → AF area mode

Use this option to determine how the camera selects the focus area for autofocus.

- When digital zoom is in effect, the camera always focuses at the center of the frame regardless of the specified setting.

👤 Face priority (default setting)

When the camera recognizes a face, it focuses on that face. See “Face Priority” (📖 56) for more information. If more than one face is recognized, the camera focuses on the face closest to the camera. When taking pictures of subjects other than people, or framing a subject with which no face is recognized, the **AF area mode** setting switches to **Auto**. When the shutter-release button is pressed halfway, the camera will automatically select the focus area containing the subject closest to the camera.

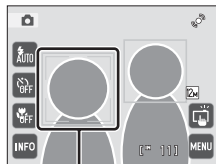

Focus area

📷 Auto

When the shutter-release button is pressed halfway, the camera automatically selects the focus area containing the subject closest to the camera and the selected focus area (up to nine areas) will be displayed in the monitor. No focus area is displayed until the shutter-release button is pressed halfway.

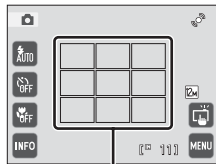

Focus areas

📷 Center

The focus area is displayed at the center of the frame. When the shutter-release button is pressed halfway, the camera focuses on the subject at the center of the frame.

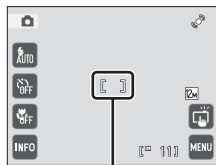

Focus area

✔ Notes on AF Area Mode

- Subjects with which autofocus may not perform as expected may be out of focus (📖 31).
- When the touch shutter (📖 34) or touch AF/AE (📖 37) function is enabled, the focus area can be selected by tapping the monitor.
- When the subject tracking (📖 40) function is enabled, the focus area moves to track the subject.
- There may be functions with which this setting cannot be enabled. See “Camera Settings that Cannot Be Applied Simultaneously” (📖 58) for more information.

Face Priority

When the camera is pointed at a human face, face recognition, which the camera automatically recognizes that face and focus on it, starts. The face priority function is activated in the following situations.

- **AF area mode** (📖 55) is set to **Face priority**
- In **Scene auto selector** (📖 60), **Portrait** (📖 62), and **Night portrait** (📖 63) scene modes
- In smart portrait mode (📖 72)

1 Frame a picture.

When the camera recognizes a face, that face is framed by a yellow double border.



When the camera detects more than one face, operation varies, depending upon the shooting mode, as follows.

Shooting mode	Faces framed by double border	Number of faces that can be recognized
📷 (auto) mode (face priority)	The face closest to the camera * Other faces framed by single border.	Up to 12
Scene auto selector, Portrait, Night portrait scene mode		
Smart portrait mode	The face closest to the center of the frame * Other faces framed by single border.	Up to 3

The camera focuses on the face framed by the double border. To select another face for focusing, tap a face framed by a single border. The border surrounding the selected face will change to a double border.

2 Press the shutter-release button halfway.

The camera focuses on the face framed by the double border. The double border will glow green once focus has been locked.

When the camera is unable to focus, the double border will blink. Press the shutter-release button halfway again and focus.

Press the shutter-release button the rest of the way down to take a picture.

If the camera detects that the face framed by the double border is smiling in smart portrait mode, the **Smile timer** (📖 74) is activated and the shutter is automatically released without the shutter-release button having been pressed.



✔ Notes on Face Priority

- If the camera is unable to recognize any faces when the shutter-release button is pressed halfway with **AF area mode** set to **Face priority**, the AF area mode setting automatically switches to **Auto**.
- If no faces are recognized when the shutter-release button is pressed halfway in **Portrait** or **Night portrait** scene mode, or smart portrait mode, the camera will focus on the subject at the center of the frame.
- The camera may be unable to recognize faces in the following situations:
 - When faces are partially hidden by sunglasses or otherwise obstructed
 - When faces take up too much or too little of the frame
- When the frame includes more than one face, the faces recognized by the camera and the face on which the camera focuses depend upon a variety of factors, including the direction in which the faces are looking.
- In some rare cases, the subject may not be in focus despite the fact that the double border glows green (📖 31). Should this occur, try pressing the shutter-release button halfway to refocus several times, or refocus on another subject positioned at the same distance from the camera as the actual portrait subject (📖 39).
- When pictures in which a face was recognized during shooting are played back in full-frame playback mode or thumbnail playback mode, depending upon the orientation of the recognized face, the pictures may be automatically rotated for playback display except pictures taken with **Continuous**, **BSS**, and **Multi-shot 16** (📖 53).

Autofocus Mode

📷 (auto) → 📄 (Shooting menu) → Autofocus mode

Choose how the camera focuses.

AF Single AF (default setting)

The camera focuses when the shutter-release button is pressed halfway or the subject on the monitor is tapped (touch shutter, touch AF/AE).

AF Full-time AF

The camera focuses continuously until the shutter-release button is pressed down halfway. Use with moving subjects. The sound of lens drive movement will be heard while the camera focuses.

Camera Settings that Cannot Be Applied Simultaneously

Some shooting settings cannot be used with other functions.

Restricted function	Setting	Description
Flash mode	Continuous (📖 53)	When Continuous , BSS , or Multi-shot 16 is selected, flash is disabled.
Image mode	Continuous (📖 53)	When Multi-shot 16 is selected, the Image mode setting is fixed at 📷 (image size: 2560 × 1920 pixels).
Continuous	Self-timer (📖 44)	When taking a picture using the self-timer, the continuous setting is fixed to Single .
ISO sensitivity	Continuous (📖 53)	When Multi-shot 16 is selected, the ISO sensitivity setting is automatically specified according to the brightness.
AF area mode	Digital zoom (📖 29)	When digital zoom is applied, the camera focuses on the subject at the center of the frame.
	Touch shutter (📖 31), Touch AF/AE (📖 34)	The camera focuses at the area tapped on the monitor.
	Subject tracking (📖 37)	When a subject has not been selected for tracking, or the camera loses the subject, the camera focuses at the center of the frame.
Electronic VR	Continuous (📖 53)	When shooting with Continuous , BSS , or Multi-shot 16 enabled, electronic VR is disabled.
	ISO sensitivity (📖 54)	When a setting other than Auto is selected for ISO sensitivity , Electronic VR is disabled.
Motion detection	Subject tracking (📖 37)	When taking a picture using the subject tracking function, Motion detection is disabled.
	Continuous (📖 53)	When Multi-shot 16 is selected, Motion detection is not enabled.
	ISO sensitivity (📖 54)	When an ISO sensitivity setting other than Auto is selected, Motion detection is disabled.
Blink warning	Continuous (📖 53)	When taking a picture using Continuous , BSS , or Multi-shot 16 , Blink warning is disabled.
Digital zoom	Continuous (📖 53)	When Multi-shot 16 is selected, digital zoom is not available.

More Information

See "Digital Zoom" (📖 148) for more information.

Shooting Suited to Scenes (Scene Mode)

Camera settings are automatically optimized for the selected subject type. The following scene modes are available.

Scene auto selector	Portrait	Landscape	Sports	Night portrait
Party/indoor	Beach/snow	Sunset	Dusk/dawn	Night landscape
Close-up	Food	Museum	Fireworks show	Copy
Draw	Backlight	Panorama assist		

Setting a Scene Mode

- 1 Press the button in shooting mode to display the shooting-mode selection menu and tap the scene mode control.

The icon for the last scene mode selected is displayed. The default setting is (**Scene auto selector**; 60).

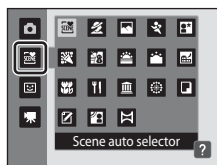

- 2 Tap the desired scene icon.

For more information about features of scene modes, see page 62.

Tap to display the help selection screen. Tap a scene icon to view a description of that scene mode.



- 3 Frame the subject and take a picture.





Functions Available in Scene Mode

- The touch shutter (34) can be enabled.
- Touch AF/AE (37) can be enabled in some scene modes.
- When is tapped to display the (scene) menu, the **Image mode** (48) and **Exposure comp.** (52) options can be adjusted. Changes made to these settings apply to all shooting modes (except movie recording).

Shooting in the Scene Mode Selected by the Camera (Scene Auto Selector)

By simply framing a picture, the camera automatically selects the optimum scene mode for simpler shooting. When a picture is framed in  (Scene auto selector) scene mode, the camera automatically selects one of the following scene modes:

- Auto (general shooting)
- Portrait ( 62)
- Landscape ( 62)
- Night portrait ( 63)
- Night landscape ( 65)
- Close-up ( 65)
- Backlight ( 67)

More on Shooting

- 1 Press the  button in shooting mode to display the shooting-mode selection menu and choose  (Scene auto selector) scene mode ( 59).

The camera enters scene auto selector scene mode.

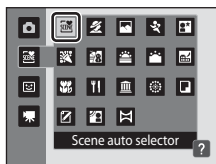

- 2 Frame the subject and take a picture.

When the camera automatically selects a scene mode, the shooting mode icon changes to that for the scene mode currently enabled.

- | | |
|---|--|
|  : Auto |  : Portrait |
|  : Landscape |  : Night portrait |
|  : Night landscape |  : Close-up |
|  : Backlight | |

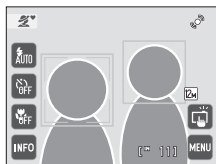



Press the shutter-release button halfway to set focus and exposure. When the subject is in focus, the active focus area glows green.

Press the shutter-release button the rest of the way down to take the picture.







✓ Notes on Scene Auto Selector Scene Mode

- Digital zoom is not available.
- Depending upon shooting conditions, the camera may not select the desired scene mode. Should this occur, switch to  (auto) mode (📖 26) or select the desired scene mode manually (📖 59).

📝 Focusing in Scene Auto Selector Scene Mode

- When the camera recognizes a human face in scene auto selector scene mode, it focuses on that face. See "Face Priority" (📖 56) for more information.
- When the shooting mode indicator  or  (close-up) is displayed, the camera automatically selects the focus area (up to nine areas) containing the subject closest to the camera as same as when **Auto** is selected for **AF area mode** (📖 55).

📝 Functions Available in Scene Auto Selector Scene Mode

- The touch shutter (📖 34) or touch AF/AE (📖 38) can be enabled.
-  **AUTO** (auto; default setting) and  (off) flash modes can be specified (📖 42). When  **AUTO** (auto) is applied, the camera automatically selects the optimum flash mode for the scene mode it has selected. When  (off) is applied, the flash does not fire, regardless of shooting conditions.
- Self-timer (📖 44) setting can be applied.
- Macro mode is disabled. Macro mode is only enabled when the camera selects **Close-up** scene mode.
- When  is tapped to display the  (scene auto selector) menu, the **Image mode** (📖 48) and **Exposure comp.** (📖 52) setting can be applied. Changes made to these settings apply to all shooting modes (except movie recording).

Selecting a Scene Mode to Take Pictures (Features)

The following icons are used for descriptions in this section: ⚡, flash mode (📖 42); ⌚, self-timer (📖 44); 🌸, macro mode (📖 45).

See “Shooting in the Scene Mode Selected by the Camera (Scene Auto Selector)” (📖 60) for more information on scene auto selector scene mode.

Portrait

Use this mode for portraits.

- When the camera recognizes a human face, that face will be framed by a yellow double border (focus area). See “Face Priority” (📖 56) for more information.
- If more than one face is recognized, the face nearest to the camera will be framed by a yellow double border (focus area) and the other faces will be framed by a single border. Tap the face framed by a single border to change the focus area to that face (📖 34, 37).
- The camera softens skin tones (in up to three faces) by applying the skin softening function before recording pictures (📖 73).
- If no faces are recognized, the camera focuses on the subject at the center of the screen by pressing the shutter-release button halfway.
- Digital zoom is not available.



Off*



Off

* Default setting can be modified.

Landscape

Use this mode for vivid landscapes and cityscapes.

- Camera focuses at infinity. The focus area or focus indicator (📖 30) always glows green when the shutter-release button is pressed halfway. Note, however, that objects in the foreground may not always be in focus.
- AF-assist illuminator (📖 147) does not light.



Off*







Off

* Default setting can be modified.

Use of a tripod is recommended in scene modes with which (📐) is indicated.

Sports

Use this mode for dynamic action shots that freeze the action in a single shot and record motion in a series of pictures.

- The camera focuses on the subject at the center of the frame and focuses continuously until focus is locked by pressing the shutter-release button halfway. The area focused can be changed by the touch shutter ( 34) or touch AF/AE ( 37).
- While the shutter-release button is held down, up to three pictures are taken at a rate of about 0.9 frames per second (fps) when image mode is set to  **4000x3000**.
- Focus, exposure, and white balance are fixed at the values determined with the first picture in each series.
- AF-assist illuminator ( 147) does not light.
- The maximum frame rate with continuous shooting may vary depending upon the current image mode setting, the memory card used, or shooting condition.





			Off		Off
---	---	---	-----	---	-----

Night portrait



Use this mode for portraits taken at sunset or at night. The flash fires to light the portrait subject while preserving background lighting to achieve a natural balance between the main subject and background ambience.

- When the camera recognizes a human face, that face will be framed by a yellow double border (focus area). See “Face Priority” ( 56) for more information.
- If more than one face is recognized, the face nearest to the camera will be framed by a yellow double border (focus area) and the other faces by a single border. Tap the face framed by a single border to change the focus area to that face ( 34, 37).
- The camera softens skin tones (in up to three faces) by applying the skin softening function before recording pictures ( 73).
- If no faces are recognized, the camera focuses on the subject at the center of the screen by pressing the shutter-release button halfway.
- Digital zoom is not available.



	 ¹		Off ²		Off
---	--	---	------------------	---	-----

¹ Fill flash with slow sync and red-eye reduction.

² Other settings can be selected.

Shooting Suited to Scenes (Scene Mode)

Party/indoor

Captures the effects of candlelight and other indoor background lighting.

- Camera focuses on subject at the center of the frame. The area focused can be changed by the touch shutter (📖 34) or touch AF/AE (📖 37).
- As pictures are easily affected by camera shake, hold the camera steadily. Use of a tripod is recommended in dark surroundings.

¹Off²

Off

¹ Slow sync with red-eye reduction flash mode may be used. The default setting can be modified.

² Default setting can be modified.

Beach/snow

Captures the brightness of such subjects as snowfields, beaches, or sunlit expanses of water.

- Camera focuses on subject at the center of the frame. The area focused can be changed by the touch shutter (📖 34) or touch AF/AE (📖 37).



AUTO*



Off*



Off

* Default setting can be modified.

Sunset



Preserves the deep hues seen in sunsets and sunrises.

- Camera focuses on subject at the center of the frame.



AUTO*



Off*



Off

* Default setting can be modified.

Dusk/dawn



Preserves the colors seen in the weak natural light before sunrise or after sunset.

- Camera focuses at infinity. The focus area or focus indicator (📖 30) always glows green when the shutter-release button is pressed halfway. Note, however, that objects in the foreground may not always be in focus.
- AF-assist illuminator (📖 147) does not light.



Off*



Off

* Default setting can be modified.

Night landscape



Slow shutter speeds are used to produce stunning night landscapes.

- Camera focuses at infinity. The focus area or focus indicator (📖 30) always glows green when the shutter-release button is pressed halfway. Note, however, that objects in the foreground may not always be in focus.
- AF-assist illuminator (📖 147) does not light.



Off*





Off

* Default setting can be modified.

Close-up

Photograph flowers, insects and other small objects at close range.

- The camera focused on the subject at the center of the frame. The area focused can be changed by the touch shutter (📖 34) or touch AF/AE (📖 37).
- Macro mode (📖 45) is enabled and the camera automatically zooms to the closest position at which it can focus.
- The closest distance at which the camera can focus varies depending on the zoom position. The camera can focus at the shortest distances when  and the zoom indicator glow green with the zoom indicator positioned to the left (wider angle) of . At the zoom position one step to the right (telephoto) of the maximum wide-angle zoom position, the camera can focus on subjects as close as 8 cm (3.2 in.) to the lens. At the maximum wide-angle zoom position and  zoom position, the camera can focus at a distance of 20 cm (8 in.).
- The camera focuses continuously until focus is locked by pressing the shutter-release button halfway.
- As pictures are easily affected by camera shake, hold the camera steadily.



AUTO*



Off*



On

* Default setting can be modified. Note that the flash may be unable to light entire subject at distances of less than 50 cm (1 ft. 8 in.).

Shooting Suited to Scenes (Scene Mode)

Food

Use when taking pictures of food.

- The camera focused on the subject at the center of the frame. The area focused can be changed by the touch shutter (📖 34) or touch AF/AE (📖 37).
- Macro mode (📖 45) is enabled and the camera automatically zooms to the closest position at which it can focus.
- The closest distance at which the camera can focus varies depending on the zoom position. The camera can focus at the shortest distances when 📷 and the zoom indicator glow green with the zoom indicator positioned to the left (wider angle) of 📷. At the zoom position one step to the right (telephoto) of the maximum wide-angle zoom position, the camera can focus on subjects as close as 8 cm (3.2 in.) to the lens. At the maximum wide-angle zoom position and 📷 zoom position, the camera can focus at a distance of 20 cm (8 in.).
- Hue can be adjusted with the slider displayed at bottom in the monitor. Drag the slider to right to make the image more reddish, or left to make it more bluish. The selected hue adjustment setting is stored in the camera's memory even after the camera is turned off, and reapplied the next time food scene mode is selected.
- The camera focuses continuously until focus is locked by pressing the shutter-release button halfway.
- As pictures are easily affected by camera shake, hold the camera steadily.

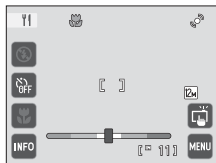

📷	📷	📷	Off*	📷	On
---	---	---	------	---	----

* Default setting can be modified.

Museum

Use indoors where flash photography is prohibited (for example, in museums and art galleries) or in other settings in which you do not want to use the flash.

- Camera focuses on subject at the center of the frame. The area focused can be changed by the touch shutter (📖 34) or touch AF/AE (📖 37).
- BSS (best shot selector) can be enabled (📖 53).
- As pictures are easily affected by camera shake, hold the camera steadily.
- AF-assist illuminator (📖 147) does not light.





📷	📷	📷	Off*	📷	Off*
---	---	---	------	---	------

* Default setting can be modified.

Fireworks show



Slow shutter speeds are used to capture the expanding burst of light from a firework.



- Camera focuses at infinity. The focus indicator () always glows green when the shutter-release button is pressed halfway. Note, however, that objects in the foreground may not always be in focus.
- AF-assist illuminator () does not light.



			Off		Off
---	---	---	-----	---	-----

Copy

Provides clear pictures of text or drawings on a white board or in print.

- Camera focuses on subject at the center of the frame. The area focused can be changed by the touch shutter () or touch AF/AE ()
- Use macro mode () to focus at short ranges.
- Colored text and drawings may not show up well.

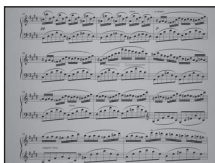

	 *		Off*		Off*
---	---	---	------	---	------

* Default setting can be modified.



Draw

Write a memo or draw a picture on the touch panel display and save it as an image. See "Using the Draw Option" () for more information.

	-		-		-
---	---	---	---	---	---

Backlight

Use when light is coming from behind subject, throwing features or details into shadow. The flash fires automatically to "fill in" (illuminate) shadows.

- Camera focuses on subject at the center of the frame. The area focused can be changed by the touch shutter () or touch AF/AE ()



			Off*		Off
---	---	---	------	---	-----

* Default setting can be modified.

Shooting Suited to Scenes (Scene Mode)

Panorama assist



Use when taking a series of pictures that will later be joined to form a single panorama using the supplied Panorama Maker software. See “Shooting for a Panorama” (📖 70) for details.



Off*





Off*

* Default setting can be modified.





Using the Draw Option



Write a memo, or draw a picture, on the touch panel display and save it as an image. The image is saved at an image size setting of **VGA 640×480**.

- 1 Press the  button in shooting mode to display the shooting-mode selection menu and choose  (**Draw**) scene mode ( 59).





- 2 Write a memo or draw pictures.

Tap  to enlarge picture display by 3x, the optimum display size for writing text or drawing pictures. Tap , , or  to change the portion of the picture in the monitor. Tap  to return to the original display size.

Tap  (pen) to write text or draw pictures, and tap  (eraser) to erase text or pictures ( 108).



- 3 Tap .

Tap , before tapping , to undo the last operation applied using the pen or erase tool (up to the last five operations can be undone).

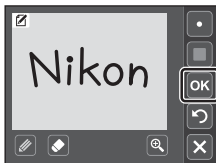

- 4 Tap **Yes**.

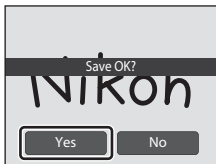

The memo is saved.

To cancel saving the memo, tap **No**.



Shooting for a Panorama

The camera focuses on the subject at the center of the frame. Use a tripod for the best results.

- 1 Press the  button in shooting mode to display the shooting-mode selection menu and choose  (**Panorama assist**) scene mode (📖 59).



Panorama direction icons are displayed to show the direction in which pictures will be joined.

- 2 Tap a direction icon.

Select the direction in which pictures will be joined in the completed panorama; right (▶), left (◀), up (▲) or down (▼).

A different direction can be selected by tapping a different panorama direction icon.

Apply flash mode (📖 42), self-timer (📖 44), and macro mode (📖 45) settings with this step, if necessary.



- 3 Take the first picture.

One third of the picture will be displayed as translucent.

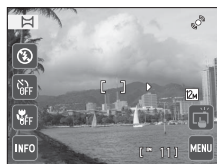

- 4 Take the next picture.

Frame the next picture so that one-third of the frame overlaps the previous picture.

Repeat this process until the necessary number of pictures have been taken to complete the scene.



5 Tap **X** when shooting is complete.

The camera returns to step 2.



✓ Notes on Panorama Assist

- Flash mode, self-timer, and macro mode settings cannot be adjusted after the first picture is taken. Pictures cannot be deleted, nor can zoom, **Image mode** setting (📖 48), or **Exposure comp.** (📖 52) be adjusted after the first picture has been taken.
- Shooting for the panorama series is terminated if the auto off function (📖 149) initiates standby mode during shooting. Setting the time allowed to elapse before the auto off function is enabled to a longer setting is recommended.

🔍 AE/AF-L Indicator

In **Panorama assist** scene mode, exposure, white balance, and focus for all pictures in a panorama are fixed at the values for the first picture in each series.

When the first picture is taken, **AE/AF-L** is displayed to indicate that exposure, white balance, and focus are locked.



🔍 Panorama Maker



Install Panorama Maker from the supplied Software Suite CD. Transfer pictures to a computer (📖 126) and use Panorama Maker (📖 130) to join them in a single panorama.

🔍 More Information

See "Image/Sound File and Folder Names" (📖 162) for more information.

Shooting Smiling Faces (Smart Portrait Mode)

At the default settings, the camera uses face priority to recognize human faces, and then automatically releases the shutter when a smile is detected (smile timer). The skin softening option can be used to smooth skin tones of human faces.

- 1 Press the  button in shooting mode to display the shooting-mode selection menu and then tap .

The camera enters smart portrait mode.

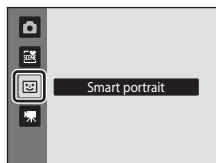

- 2 Frame a picture.

Point the camera at the subject.

When the camera recognizes a human face, a yellow double border (focus area) is displayed around that face. When focus is acquired on that face, the double border will turn green for a moment and focus is locked.



Up to three faces can be recognized. When the camera detects more than one face, the double border is displayed around the face closest to the center of the frame, and single borders around the others. When a face framed by a single border is tapped, the single border changes to a double border and the camera focuses on that face.

- 3 The shutter is automatically released.

If the camera detects that the face framed by the double border is smiling, **Smile timer** (📖 74) is activated and the shutter is automatically released.

When the camera recognizes a face, the self-timer lamp (📖 4) blinks. Immediately after the shutter is released, the self-timer lamp flickers. Each time the shutter is released, the camera again initiates face recognition and smile detection operations for continuous automatic shooting.

Pictures can also be taken by pressing the shutter release button. The camera can focus on the subject at the center of the frame when faces are not recognized.

When the shutter is released, the camera softens the subject's skin to make it appear smoother and then records the image (**Skin softening**; 📖 74).

- 4 Shooting ends.

To stop automatic shooting of smiling faces, either turn the camera off, set **Smile timer** to **Off**, or press the  button and select another shooting mode.

✔ Notes on Smart Portrait Mode

- Digital zoom is not available.
- Under some shooting conditions, the camera may be unable to recognize faces or detect smiles.
- See "Notes on Face Priority" (📖 57) for more information.

✔ Notes on Skin Softening

- More time than usual may be required to save a picture when shooting with skin softening function.
- In some shooting conditions, facial skin tones may not be smoothed or parts other than face may be modified though the camera recognizes a face. If the desired results are not produced, set **Skin softening** to **Off** and shoot again.
- The skin softening level cannot be adjusted when the portrait or night portrait is selected in the scene mode.
- Skin softening can also be applied on recorded pictures (📖 112).

🔪 Auto Power Off in Smile Timer Mode

When **Smile timer** is set to **On**, the auto power off function (📖 149) is activated and the camera turns off when either of the situations indicated below persists and no other operations are performed.

- The camera does not recognize any faces.
- The camera recognized a face, but cannot detect a smile.

🔪 Functions Available in Smart Portrait Mode

- The touch shutter (📖 34) function can be enabled when **Smile timer** is set to **Off**.
- The touch AF/AE (📖 37) function can be enabled.
- Flash cannot be used when **Blink proof** is set to **On**. When **Blink proof** is set to **Off**, flash mode (📖 42) is set to **⚡AUTO** (auto) (can be modified).
- The self timer (📖 44) options can be applied when **Smile timer** is set to **Off**.
- Macro mode cannot be used.
- Tap **MENU** to display 😊 (smart portrait) menu and adjust **Image mode**, **Skin softening**, **Smile timer**, **Exposure comp.**, and **Blink proof** (📖 74).

🔪 More Information

See "Autofocus" (📖 31) for more information.

Smart Portrait Menu

The following options can be applied in the smart portrait menu.

Tap **MENU** (📖 14) in smart portrait mode (📖 72) to display the smart portrait menu and tap menu items to adjust settings.

Image mode

Adjust **Image mode** (📖 48).

Changes made to the image mode setting apply to all shooting modes (except movie recording).

Skin softening

Enable skin softening. When the shutter is released, the camera detects one or more human faces (up to three), and processes the image to soften facial skin tones before saving the picture.

The degree of skin softening applied can be selected from **High**, **Normal** (default setting), and **Low**. When **Off** is selected, the skin softening function is disabled.

- The current setting can be confirmed by the indicator displayed in the monitor with shooting (📖 11). No indicator is displayed when **Off** is selected. The effects of skin softening are not visible when framing pictures for shooting. Check the degree of skin softening performed in playback mode.

Smile timer

- **On** (default setting): The camera uses face priority to recognize a human face, and then automatically releases the shutter whenever a smile is detected.
- **Off**: The camera does not release the shutter automatically with smile detection. Press the shutter-release button or tap the subject on the monitor to take a picture.
- When smile timer is enabled, an indicator is displayed in the monitor with shooting (📖 11). No indicator is displayed when **Off** is selected.

Exposure comp.

Adjust **Exposure comp.** (📖 52) with shooting in smart portrait mode.



Blink proof

When **On** is selected, the camera automatically releases the shutter twice each time a picture is taken. Of the two shots, one in which the subject's eyes are open is saved.

- If the camera saved a picture in which the subject's eyes may have been closed, the dialog shown at right is displayed for a few seconds.
- Flash cannot be used when **On** is selected.
- The default setting is **Off**.
- The current setting is displayed in the monitor (📖 11). No indicator is displayed when **Off** is selected.







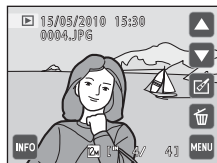



















Operations in Full-frame Playback Mode

Press the  (playback) button to enter playback mode and display pictures that have been taken ( 32).



The following operations are available in full-frame playback mode.

Option	Use	Description	
View thumbnails		Rotate the zoom control to W () to display 4, 9 or 16 picture thumbnails.	77
Playback zoom		Rotate the zoom control to T () to enlarge the picture up to 10x. Tap  to return to full-frame playback mode.	79
Toggle displayed operation controls and information display on and off		Tap  to toggle displayed operation controls and information display on and off.	12
Select a picture	 or 	Tap  or  , or drag the picture to display previous or subsequent picture. Drag your finger quickly across half of the monitor or more to skip past the previous or subsequent five pictures.	32
Edit pictures		Tap  to display the retouch menu. Pictures can be added to or removed from albums.	81, 84, 102, 103, 105
Playback movies		Tap  to play back the movie currently displayed.	123
Delete pictures		Tap  to delete the picture currently displayed.	33
Display playback menu		Tap  to display the menu for the selected mode.	93
Switch to another playback mode		Press the  button to display the playback-mode selection menu and change to favorite pictures, auto sort, or list by date mode.	80
Switch to shooting mode		Press the  button or the shutter-release button.	32
			

Viewing Pictures

When pictures in which a face was recognized during shooting (📖 56) are displayed in full-frame playback mode, depending upon the orientation of the recognized face, the pictures may be automatically rotated for playback display except pictures taken with **Continuous**, **BSS**, and **Multi-shot 16** (📖 53).

Viewing Multiple Pictures: Thumbnail Playback

Rotate the zoom control to **W** (📐) in full-frame playback mode (📖 75) to display pictures in “contact sheets” of thumbnail images.

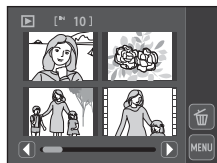

The following operations are available while thumbnails are displayed.

To	Use	Description	📖
Increase the number of pictures displayed	W (📐)	Rotate the zoom control to W (📐) to increase the number of the picture thumbnails displayed: 4 → 9 → 16.	
Decrease the number of pictures displayed	T (📐)	Rotate the zoom control to T (📐) to decrease the number of picture thumbnails displayed: 16 → 9 → 4. Rotate the zoom control to T (📐) in 4-picture thumbnail display to return to full-frame playback mode.	–
Scroll display	⏪ or ⏩	Tap ⏪ or ⏩, or tap the slider at the bottom of the screen.	–
Switch to full-frame playback mode	–	Tap a picture.	–
Delete pictures	🗑️	Tap 🗑️ to select pictures for deletion. Tap the pictures to be deleted and tap OK .	–
Switch to shooting mode	📷	Press the 📷 button or the shutter-release button.	32
	⏴		

📌 Thumbnail Playback Mode Display

When pictures marked using **Print set** (📖 94) or **Protect** (📖 100) are selected, the icons shown at right are displayed with them. Movies are displayed as film frames.

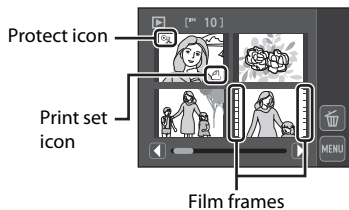

Thumbnail Display in Favorite Pictures and Auto Sort Mode

- When thumbnails are displayed in favorite pictures mode ( 81), the favorite pictures icon is displayed at right above the thumbnails.

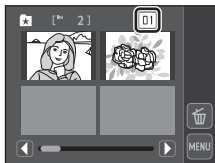

- When thumbnails are displayed in auto sort mode ( 88), the pictures' category icon is displayed at right above the thumbnails.

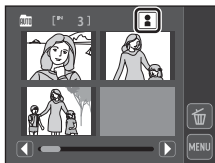

Taking a Closer Look: Playback Zoom

Rotating the zoom control to **T** (🔍) in full-frame playback mode (📖 75) enlarges display of the center portion of the current picture.

- The guide displayed at bottom right shows the portion of the image currently displayed.

The following operations can be performed while picture display is enlarged.



To	Use	Description	📖
Zoom in	T (🔍)	Zoom increases each time the zoom control is rotated to T (🔍), to a maximum of 10x.	–
Zoom out	W (📐)	Zoom decreases each time the zoom control is rotated to W (📐). When the magnification ratio reaches 1x, the display returns to full-frame playback mode.	–
Change the display area	–	The area of the picture currently displayed can be changed by dragging the picture.	–
Delete pictures	🗑️	Tap 🗑️ to delete the picture.	32
Switch to full-frame playback	⌫	Tap ⌫ to switch to full-frame playback.	33
Crop picture	✂️	Tap ✂️ to crop current picture to contain only the portion visible in the monitor.	118
Switch to shooting mode	📷	Press the 📷 button or the shutter-release button.	32
	⬇️		





Pictures Taken with Face Priority

When zooming in (playback zoom) on a picture taken using the face priority function (📖 56) by rotating the zoom control to **T** (🔍), the picture will be enlarged with the face recognized with shooting at the center of the monitor (except pictures taken with **Continuous**, **BSS**, and **Multi-shot 16**; 📖 53).

- If more than one face was recognized, the picture will be enlarged with the face on which focus was acquired at the center of the monitor. Tap 📷 or 📷 to display other recognized faces.
- When the zoom control is rotated to **T** (🔍) or **W** (📐) to adjust the zoom ratio, the center of the picture (normal playback zoom display), rather than the face, is displayed at the center of the monitor.



Selecting Playback Mode

Select a playback mode from  (playback),  (favorite pictures),  (auto sort), and  (list by date) modes.

- 1 Press the  button in playback mode.

The playbackmode menu is displayed.

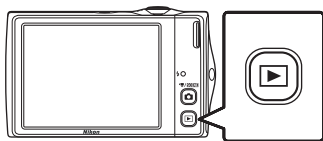



- 2 Tap the desired playback mode control.



The camera enters the selected playback mode.

To return to the current playback mode without switching playback modes, press the  button.





- | | | |
|---|---|--|
| 1 |  Playback mode |  32 |
|---|---|--|



Play back all pictures.

- | | | |
|---|--|--|
| 2 |  Favorite pictures mode |  81 |
|---|--|--|

Play back pictures added to an album.

- | | | |
|---|--|--|
| 3 |  Auto sort mode |  88 |
|---|--|--|

Play back pictures and movies automatically sorted to the selected category with shooting.

- | | | |
|---|---|--|
| 4 |  List by date mode |  91 |
|---|---|--|

Play back pictures taken on the selected date.

Sorting Favorite Pictures (Favorite Pictures Mode)

Pictures can be sorted to albums. Once pictures have been sorted to albums, favorite picture mode can be used to play back only the pictures in a specific album. Adding pictures to albums makes finding a particular picture faster and easier. Pictures can be sorted to albums categorized by themes such as travel or weddings. A single picture can be added to multiple albums.

Adding Pictures to Albums

Pictures can be added to albums and sorted.

1 Display pictures in playback mode (📖 32), auto sort mode (📖 88), or list by date mode (📖 91).

2 Select a picture and tap .

Display a picture in full-frame playback mode and tap .
The retouch menu is displayed.

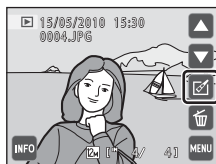

3 Tap .

The albums selection screen is displayed.

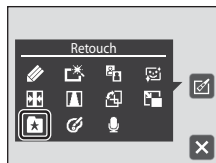

4 Tap the desired album.

The picture is added to the album and monitor display returns to full-frame playback mode.

Repeat step 1 and 2 to add a picture to multiple albums.

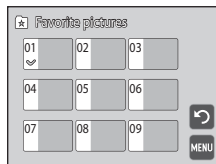

Sorting Favorite Pictures (Favorite Pictures Mode)

Notes on Adding Favorite Pictures

- An album can contain up to 200 pictures.
- Movies cannot be added to albums.
- If the selected picture has already been added to an album, the checkbox for the album to which it has been added will be checked (✔).
- When pictures are added to albums, they are not physically copied to albums or moved from the folder (📁 162) to which they were originally recorded (📁 87).

More Information

See "Removing Pictures from Albums" (📁 84) for more information.

Viewing Pictures in an Album

Pictures can be displayed by selecting the album to which they were added in “★ favorite pictures mode”.

- In full-frame playback mode, just as with normal playback mode, pictures can be displayed as thumbnails and picture display can be enlarged. Still pictures can be edited.
- When **MENU** is tapped in full-frame or thumbnail playback mode to display the favorite pictures menu (📖 85), all pictures sorted to the specified album can be selected for deletion, viewing in a slide show, printing, or protection.

- 1 Press the **▶** button in playback mode to display the playback-mode selection menu and tap **★**.

A list of albums is displayed.

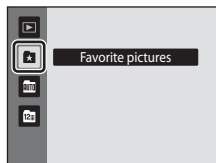

- 2 Tap the desired album.

The pictures in the selected album will be displayed in full-frame playback mode.





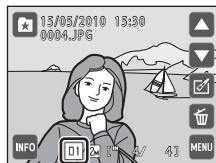
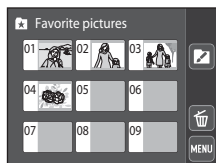







The icon for the current album is displayed on the screen.

Tap **▶** in full-frame playback mode to return to the album selection screen.







Using Favorite Pictures Mode

The following operations are available in the album list screen.



To	Use	Description	
Change album icon		Change the icon assigned to an album.	86
Delete pictures added to the specified album		Tap  to display the album selection screen. Select the desired album and tap  to delete all pictures added to that album.	–
Switch to favorite pictures menu		Tap  to display the favorite pictures menu.	85
Change playback mode		Press the  button to display the playback-mode selection menu.	80
Switch to shooting mode		Press the  button or the shutter-release button.	32
			

Favorite Pictures Menu

Tap  in favorite pictures mode to apply the following menu options for only pictures in the selected album.

- Print set →  94
- Slide show* →  97
- Delete →  98
- Protect* →  100



* During full-frame playback only

When  is tapped in the album list screen ( 83), the print set option can be applied to all pictures in the specified album, or all pictures in the specified album can be deleted.

To apply options to individual pictures or to select individual pictures, for deletion, for example, tap  in full-frame display.

Changing Icons Assigned to Albums

The icon assigned to an album can be changed to reflect the theme of pictures included in the album.

- 1 Press the  button in playback mode to display the playback-mode selection menu and tap .

A list of albums is displayed.

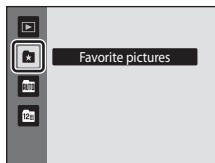

- 2 Tap .

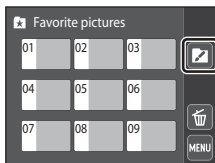

- 3 Tap the desired folder.

The album icon and icon color selection screen is displayed.

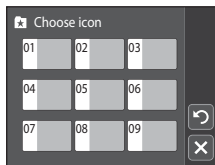

- 4 Tap the desired icon and color and tap .

The icon is modified and the monitor display returns to the list of albums.

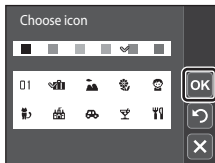

Notes on Icons for Albums

Choose icons for albums separately for the internal memory and for every memory card used.

- To change the icon for an album containing pictures stored in the internal memory, remove the memory card from the camera.
- The default setting for icons are black numbers.

Adding/Viewing Favorite Pictures

When pictures are added to albums, they are not physically copied to albums or moved from the folder to which they were originally recorded (📖 162). Only the file names of pictures are added to albums. In favorite pictures mode, pictures with file names that have been added to the specified album are played back. Note that deleting a picture (📖 33, 85, 98) played back in favorite pictures mode deletes not only the picture from the album, but also deletes the original picture from the internal memory or memory card permanently.

Adding Pictures to Albums

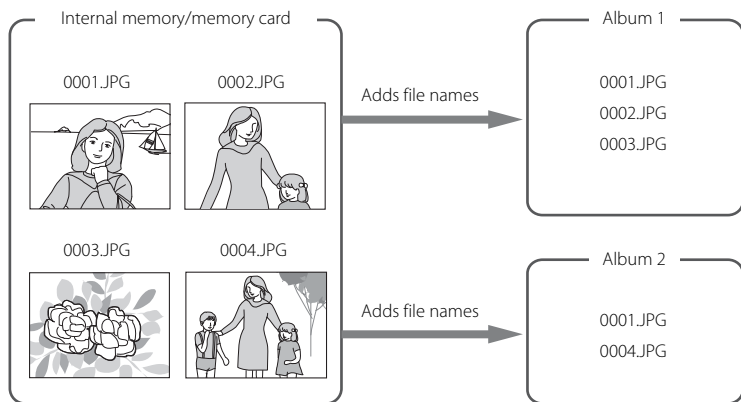

More on Playback

Favorites Picture Playback

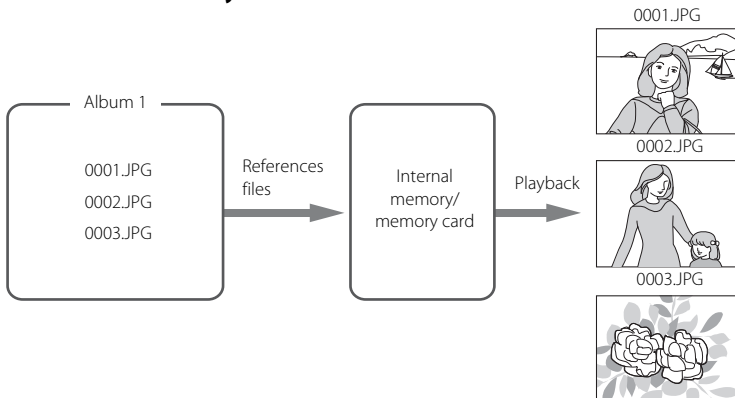















Image Searching in Auto Sort Mode

Pictures and movies are automatically sorted to any of the following categories with shooting. When “ (auto sort) mode” is selected, pictures and movies can be viewed by selecting the category to which they were sorted.

 Smile	 Portraits	 Food
 Landscape	 Dusk to dawn	 Close-ups
 Movie	 Retouched copies	 Other scenes

- In full-frame playback mode, just as with normal playback mode, pictures can be displayed as thumbnails and picture display can be enlarged. Still pictures can be edited and added to albums, and movies can be played back.
- When  is tapped, the auto sort menu ( 90) is displayed and all pictures sorted to the specified category can be selected for deletion, viewing in a slide show, or applying print order or protection settings.

Viewing Pictures in Auto Sort Mode

- 1 Press the  button in playback mode to display the playback-mode selection menu and tap .

A list of categories is displayed.

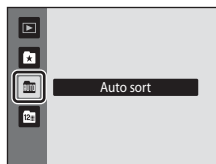

- 2 Tap the desired category.

For more information on categories, see “Auto Sort Mode Categories” ( 89).







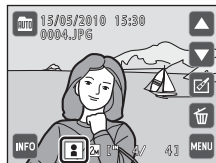
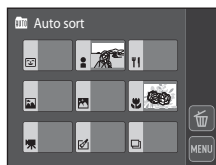



A picture sorted to the selected category will be displayed in full-frame playback mode.

The icon for the category currently selected is displayed at the bottom of the screen.

Tap  in full-frame display to return to the list of categories.



Auto Sort Mode Categories

Category	Description
 Smile	Pictures taken in smart portrait mode (📖 72) with the smile timer setting set to On are displayed.
 Portraits	Pictures taken in  (auto) mode (📖 26) with the face priority. Pictures taken in Portrait* , Night Portrait* , Party/indoor , and Backlight* scene mode (📖 59). Pictures taken in smart portrait mode (📖 72) with the smile timer setting set to Off .
 Food	Pictures taken in Food scene mode (📖 59).
 Landscape	Pictures taken in Landscape* scene mode (📖 59).
 Night landscape	Pictures taken in Night landscape* , Sunset , Dusk/dawn , and Fireworks show scene mode (📖 59).
 Close-ups	Pictures taken in  (auto) mode with macro mode (📖 45). Pictures taken in Close-up* scene mode (📖 59).
 Movie	Movies (📖 119).
 Retouched copies	Copies created using editing function (📖 105).
 Other scenes	All other pictures that cannot be defined by the categories described above are displayed.











* Pictures taken in scene auto selector scene mode (📖 60) are also sorted to the appropriate categories.

Notes on Auto Sort Mode

- Up to 999 pictures and movie files can be sorted to each category in auto sort mode. If 999 pictures or movies have already been sorted to a specific category, new pictures and movies cannot be sorted to that category or displayed in auto sort mode. Display pictures and movies that could not be sorted to a category in normal playback mode (📖 32) or list by date mode (📖 91).
- Pictures or movies copied from the internal memory to a memory card, or vice versa (📖 100), cannot be displayed in auto sort mode.
- Pictures or movies recorded by a camera other than the COOLPIX S4000 cannot be displayed in auto sort mode.





Using Auto Sort Mode

The following operations are available in the category list screen.



To	Use	Description	
Delete pictures sorted to the specified category		Tap  to display the category selection screen. Select the desired category and tap  to delete all pictures sorted to that category.	–
View auto sort menu		Tap  to display the auto sort menu.	90
Switch to another playback mode		Press the  button to display the playback-mode selection menu.	80
Switch to shooting mode		Press the  button or the shutter-release button.	32
			

Auto Sort Menu

Tap  in auto sort mode to apply the following menu options for only the pictures sorted to the specified category.

- Print set →  94
- Slide show* →  97
- Delete →  98
- Protect* →  100



* During full-frame playback only

When  is tapped in the category list screen ( 88), the print set option can be applied to all pictures sorted to the same category, or all pictures sorted to the same category can be deleted.



To apply options to individual pictures or to select individual pictures for deletion, for example, tap  in full-frame display.

Viewing Pictures by Date (List by Date Mode)

In “ list by date mode”, pictures taken on a same date can be played back.

- In full-frame playback mode, just as with normal playback mode, picture display can be enlarged, pictures can be displayed in thumbnails, edited, or added to albums, and movies can be played back.
- When  is tapped, the list by date menu ( 92) is displayed and all pictures taken on a specified date can be selected for deletion, viewing in a slide show, or applying print order or protection settings.

Selecting a Date in List by Date Mode

- 1 Press the  button in playback mode to display the playback-mode selection menu and tap .

Dates for which pictures exist are listed.



- 2 Tap the desired date.

The camera lists up to 29 dates. If pictures exist for more than 29 dates, all pictures recorded earlier than most recent 29 dates will be combined under **Others**.



The first picture taken on the selected date will be displayed full-frame.

Tap  in the full-frame display to return to the list by date screen.

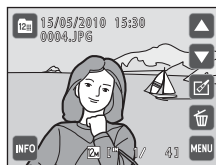















Notes on List by Date Mode

- Up to 9,000 of the most recently recorded pictures can be displayed in list by date mode. If more pictures are exist, “*” is displayed next to the number of pictures for the date containing the 9001st most recent picture.
- Pictures taken before the date and time have been set are recognized as having been taken on January 1, 2010.





Using List by Date Mode

The following operations are available in the list by date screen.



To	Use	Description	
Scroll display	 or 	Tap  or  or drag the slider displayed at the bottom of the screen.	–
Delete pictures taken on the specified date		Tap  to display the date selection screen. Select the desired date and tap OK to delete all pictures taken on that date.	–
View list by date menu		Tap  to display the list by date menu.	92
Switch to another playback mode		Press the  button to display the playback-mode selection menu.	80
Switch to shooting mode		Press the  button or the shutter-release button.	32
			

List by Date Menu

Tap  in list by date mode to apply the following menu options for only the pictures taken on the specified date.

- Print set →  94
- Slide show* →  97
- Delete →  98
- Protect* →  100

* During full-frame playback only

When  is tapped in the list by date screen ( 91), the print set option can be applied to all pictures taken on the same date, or all pictures taken on the same date can be deleted.

To apply options to individual pictures or to select individual pictures for deletion, for example, tap  in full-frame display.

Playback Options: The Playback Menu

The following options are enabled in the playback menu.

Print set

94

Select pictures to print and the number of copies for each.

Slide show

97

View pictures stored in the internal memory or on a memory card in an automatic slide show.

Delete

98

Delete all or selected pictures. Multiple pictures can be deleted at a time.

Protect

100

Protect selected pictures from accidental deletion.

Copy

100

Copy files between memory card and internal memory.

Displaying the Playback Menu

Press the  button to enter playback mode (32).

Tap  to display the playback menu.

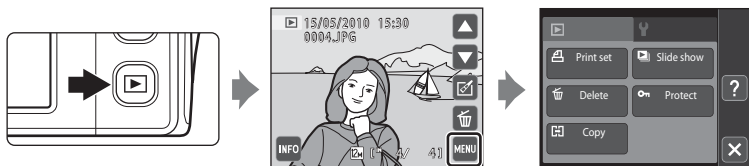



- Tap menu items to adjust settings.
- Tap  to exit the playback menu.

Print Set (Creating a DPOF Print Order)

▶ button (Playback mode) → **MENU** (Playback menu) →  Print set

When printing pictures stored on the memory card using any of the following methods, the **Print set** option in the playback menu is used to create digital “print orders” for printing on DPOF-compatible devices.

- Inserting the memory card into a DPOF-compatible ( 177) printer’s card slot
- Taking the memory card to a digital photo lab
- Connecting the camera to a PictBridge-compatible ( 177) printer ( 132). A print order can also be created for pictures stored in the internal memory if the memory card is removed from the camera

More on Playback

1 Tap **MENU** in playback mode.

The playback menu is displayed.

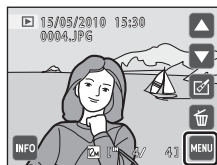

2 Tap **Print set**.

Proceed to step 4 when playing back with favorite pictures mode, auto sort mode, or list by date mode.

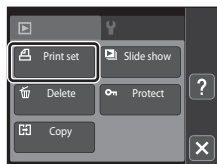

3 Tap **Select images**.

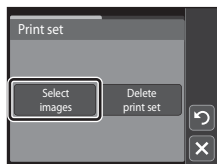

4 Choose pictures (up to 99) and the number of copies (up to nine) of each.

Tap the desired picture and tap **+** or **-** to specify the number of copies to be printed.

Pictures selected for printing can be recognized by the check mark (✓) icon and the numeral indicating the number of copies to be printed. If no copies have been specified for pictures, the selection is canceled.

Tap **Q** or rotate the zoom control to **T** (Q) to switch to full-frame playback.

Tap **W** or rotate the zoom control to **W** (W) to switch back to 6-thumbail display.

Tap **OK** when setting is complete.

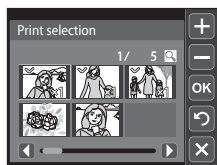

5 Choose whether or not to print shooting date and photo information.

Tap **Date** to print the shooting date on all pictures in the print order.

Tap **Info** to print photo information (shutter speed and aperture) on all pictures in the print order.

Tap **OK** to complete the print order and exit.

Pictures selected for printing are recognized by the  icon displayed with playback.

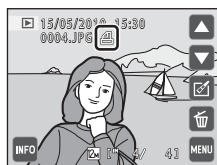
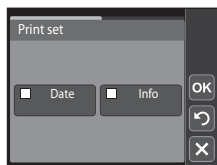

✓ Notes on Printing Shooting Date and Photo Information

When the **Date** and **Info** options are enabled in the print set option, shooting date and photo information are printed on pictures when a DPOF-compatible printer (📖 177) that supports printing of shooting date and photo information is used.

- Photo information cannot be printed when the camera is connected directly to a printer, via the supplied USB cable, for DPOF printing (📖 137).
- Note that **Date** and **Info** settings are reset when the print set option is displayed.
- The date printed is that recorded when the picture was taken. Changing the camera's date using the **Date** option in the setup menu after a picture has been taken has no effect on the date printed on the picture.



✓ Notes on Print Set

When a print order is created in favorite pictures mode, auto sort mode, or list by date mode, the screen shown below is displayed if pictures other than those in the selected album or category, or taken on the selected shooting date, have been marked for printing.

- Select **Yes** to add pictures in the selected album or category, or taken on the selected shooting date, to the existing print order.
- Select **No** to remove print marking from previously marked pictures and restrict the print order to pictures in the selected album or category, or taken on the selected shooting date.

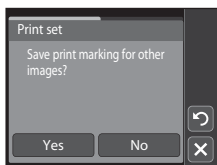

Favorite pictures mode/
auto sort mode

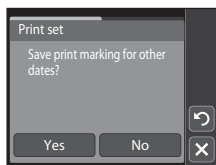

List by date mode

If the total number of the pictures in a print order exceeds 99, the screen shown below will be displayed.

- Select **Yes** to remove pictures previously added from the print order and restrict the print order to pictures just marked.
- Select **Cancel** to remove the pictures just added from the print order and restrict the print order to pictures previously marked.

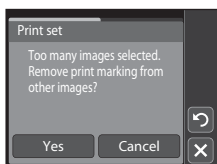

Favorite pictures mode/
auto sort mode

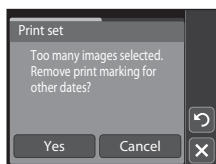

List by date mode

✂ Canceling Existing Print Order



Tap **Delete print set** in step 3 of "Print Set (Creating a DPOF Print Order)" (📖 94) to remove print marking from all pictures and cancel the print order.

🕒 Date Imprint

When date and time of recording are imprinted on pictures using the **Date imprint** option (📖 144) in the setup menu, pictures are recorded with shooting date and time imprinted on the picture when they are taken. Pictures with the date imprinted on them can be printed from printers that do not support printing of the date on pictures.

Only the date and time imprinted on pictures with the date imprint option will be printed, even if the **Print set** date option is enabled.

Slide Show

▶ button (Playback mode) →  (Playback menu) →  Slide show

Play back pictures stored in the internal memory or on a memory card one by one in an automated “slide show.”

1 Tap **Start**.

To change the interval between pictures, tap **Frame intvl** and select the desired interval before tapping **Start**.

To repeat the slide show automatically, tap **Loop** before choosing **Start**. A check mark (✓) will be added to the loop option when enabled.

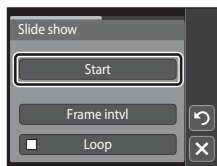





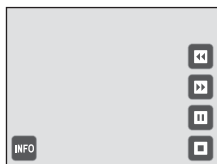





2 The slide show begins.

Tap the monitor to display operation controls and  to hide them.



Tap a control to perform the corresponding operation. The following operations are available.

To	Use	Description
Rewind		Touch and hold  to rewind.
Advance		Touch and hold  to advance.
Pause		Pause playback. The following operations can be performed while playback is paused using the controls displayed at right in the monitor.
		 Rewind slide show back one frame. Touch and hold  for continuous frame-by-frame rewind.
		 Advance slide show forward one frame. Touch and hold  for continuous frame-by-frame advance.
		 Resume playback.
End		End playback and return to the playback menu.

Notes on Slide Show

- Only the first frame of movies included in slide shows is displayed.
- Even when **Loop** is selected, the slide show will only be played for a maximum of 30 minutes ( 149).

Delete (Deleting Multiple Pictures)

 button (Playback mode) →  (Playback menu) →  Delete

Delete selected pictures or all pictures.



Select images

Select pictures from the picture selection screen and delete them. See “Selecting Pictures” ( 99) for more information.

Erase all images

Delete all pictures. In favorite pictures, auto sort, or list by date mode, all pictures in the selected album or category, or taken on the selected date currently played back are deleted.

Notes on Deletion

- Once deleted, pictures cannot be recovered. Transfer important pictures to a computer before deleting them.
- Pictures marked with the  icon are protected and cannot be deleted ( 100).

Selecting Pictures

The picture selection screen like that shown at right is displayed with the following menu selections:

- **Playback menu: Print set>Select images** (📖 94),
Delete>Select images (📖 98),
Protect (📖 100), and
Copy>Selected images (📖 100)
- **Setup menu: Welcome screen >Select an image** (📖 140)



Follow the procedures described below to choose pictures.

1 Tap the desired picture to select and tap again to deselect.

Only one picture can be selected for **Welcome screen**.

Tap **Q** or rotate the zoom control to **T (Q)** to switch to full-frame playback. Tap **W** or rotate the zoom control to **W (W)** to switch back to 6-thumbnail display.

When picture is selected, a check mark (✓) is displayed in the top left corner of the picture.

When selecting pictures for **Print set**, tap **+** or **-** to specify the number of copies for each.



2 Tap **OK** to apply picture selection.

When **Select images** is selected, a confirmation dialog is displayed. Follow the instructions displayed in the monitor.

Protect

 button (Playback mode) →  (Playback menu) →  Protect

Protect selected pictures from accidental deletion.

Tap pictures to protect or cancel protection for previously protected pictures from the picture selection screen. See “Selecting Pictures” (📖 99) for more information.

Note that formatting the camera’s internal memory or the memory card will permanently delete protected files (📖 150).

Protected pictures are recognized by the  icon (📖 13, 77).

Copy (Copy Between Internal Memory and Memory Card)

 button (Playback mode) →  (Playback menu) →  Copy

Copy pictures between the internal memory and a memory card.

1 Tap the desired option from the copy screen.

 → : Copy pictures from internal memory to memory card.

 → : Copy pictures from memory card to internal memory.

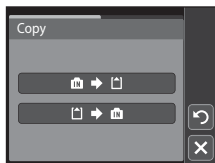

2 Tap the desired copy option.

Selected images: Copy pictures selected from the picture selection screen (📖 99).

All images: Copy all pictures.

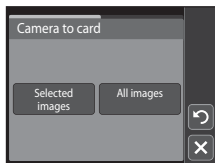

Notes on Copying Pictures

- JPEG-, AVI-, and WAV-format files can be copied. Files recorded in any other format cannot be copied.
- If voice memos (📖 103) are attached to pictures selected for copying, voice memos are copied with the pictures.
- Operation is not guaranteed with pictures taken with another make of camera or that have been modified on a computer.
- When copying pictures selected for a **Print set** (📖 94), the print set marking is not copied. However, **Protect** (📖 100) settings are copied with pictures.
- Pictures or movies copied from the internal memory to a memory card, or vice versa, cannot be displayed in auto sort mode (📖 88).
- When pictures added to albums (📖 81) are copied, the copies are not automatically added to the same albums as the original pictures.

"Memory contains no images." Message

If there are no pictures stored on a memory card inserted in the camera when playback mode is applied, the message **Memory contains no images.** will be displayed. Tap  to display the copy option screen, and copy the pictures stored in the camera's internal memory to the memory card.

More Information

See "Image/Sound File and Folder Names" (📖 162) for more information.

Rotate Image

Specify the orientation in which recorded pictures are displayed with playback. Still pictures can be rotated 90 degrees clockwise or 90 degrees counterclockwise. Pictures that were recorded in portrait ("tall") orientation can be rotated up to 180 degrees in either direction.

- 1 Select a picture in the full-frame playback mode (📖 75) and tap .

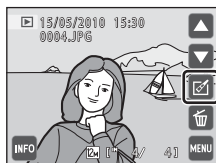

The retouch menu is displayed.

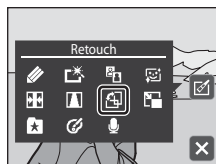

- 2 Tap .

The rotate image screen is displayed.



- 3 Tap  or .

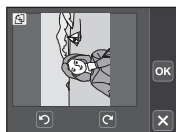

Rotate 90 degrees
counterclockwise

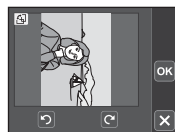

Rotate 90 degrees
clockwise

The picture rotates 90 degrees.

Tap  to finalize display orientation and save the orientation information with the picture.

Tap  to return to full-frame playback mode.

Voice Memos: Recording and Playback

Use the camera's built-in microphone to record voice memos for pictures.

Recording Voice Memos

- 1 Select the desired picture from full-frame playback mode (📖 75) and tap .

The retouch menu is displayed.

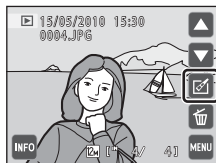

- 2 Tap .

The screen for recording voice memos is displayed.

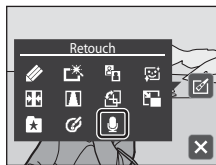

- 3 Tap  to record a voice memo.

Recording ends after about 20 seconds.

Do not touch the built-in microphone during recording.

During recording, **REC** blinks in the monitor.

Recording ends when  is tapped during recording.

When recording ends, the voice memo playback screen is displayed. Follow the instructions in step 3 of "Playing Voice Memos" (📖 104) to play the voice memo.

Tap  to return to full-frame playback mode.

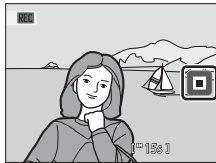



More Information

See "Image/Sound File and Folder Names" (📖 162) for more information.

Playing Voice Memos

Pictures for which voice memos have been recorded are indicated by  in full-frame playback mode.

- 1 Select the desired picture from full-frame playback mode ( 75) and tap .

The retouch menu is displayed.

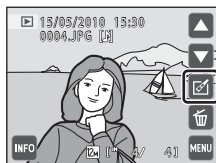

- 2 Tap .

The voice memo playback screen is displayed.

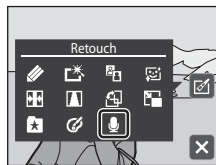

- 3 Tap  to play the voice memo.

Tap  to stop playback.

Tap  during playback to adjust playback volume.

 blinks during playback.

Tap  to return to full-frame playback mode.



Deleting Voice Memos

Tap  in step 3 of "Playing Voice Memos". Tap **Yes** to delete only the voice memo.



Notes on Voice Memos

- When a picture with a voice memo attached is deleted, both the picture and its voice memo are deleted.
- If a voice memo already exists for the current picture, it must be deleted before a new voice memo can be recorded.
- The COOLPIX S4000 is not able to record a voice memo for pictures taken with another make or model of digital camera.

Editing Functions

Use the COOLPIX S4000 to edit pictures in-camera and store them as separate files (📖 162). The editing functions described below are available.

Editing function	Description
Paint (📖 107)	Draw on pictures, or add decorations, to pictures.
Quick retouch (📖 110)	Easily create retouched copies in which contrast and saturation have been enhanced.
D-Lighting (📖 111)	Create a copy of the current picture with enhanced brightness and contrast, brightening dark portions of the picture.
Skin softening (📖 112)	Make facial skin tones softer.
Stretch (📖 114)	Stretch the current picture horizontally to make the subject appear thinner or wider.
Perspective control (📖 115)	Adjust the perspective of pictures taken in landscape orientation. Apply perspective control similar to that available with shift lenses. This option is suited to pictures of buildings or architecture.
Small picture (📖 116)	Create a small copy of pictures suitable for use as e-mail attachments.
Color options (📖 117)	Make colors more vivid or record pictures in monochrome.
Crop (📖 118)	Crop a portion of the picture. Use to zoom in on a subject or arrange a composition.

See page 102 for the rotate image function and page 103 for the voice memo function for more information.

✓ Notes on Picture Editing

- Pictures taken at an **Image mode** setting (📖 48) of **3968x2232** cannot be edited.
- The editing functions of this camera cannot be used for pictures taken with another make or model of digital cameras.
- If no face is recognized in a picture, a copy cannot be created using the skin softening function (📖 112).
- Edited copies created with this camera may not be displayed properly on a different model of digital camera. It may also be impossible to transfer them to a computer using a different model of digital camera.
- Editing functions are not available when there is not enough free space in the internal memory or on the memory card to store the edited copies.

Restrictions on Picture Editing

When an edited copy is further modified with another editing function, check the following restrictions.

Editing function used	Editing function to add
Paint	The paint, small picture, or crop function can be added.
Quick retouch D-Lighting Color options Stretch Perspective control	The paint, small picture, skin softening, or crop functions can be added.
Skin softening	The editing functions other than the skin softening can be added.
Small picture	Another editing function cannot be added.
Crop	Another editing function cannot be added. However, the paint function can be applied to cropped copies saved at an image size of 640 × 480 pixels or larger.

- Copies created with editing functions other than the paint function cannot be further edited with the same function used to create them.
- When combining the small picture or crop function and another editing function, use the small picture and crop functions after other editing functions have been applied.
- The skin softening function can be added to the picture taken with skin softening (📖 74).
- Images created in draw scene mode (📖 69) can only be edited with the paint, small picture, or crop function.

Original and Edited Pictures

- Copies created with editing functions are not deleted if the original pictures are deleted. The original pictures are not deleted if copies created with editing functions are deleted.
- Edited copies are stored with the same recording date and time as the original.
- Print marking (📖 94) and protect settings (📖 100) do not remain effective in edited copies.

Picture Editing

Paint: Painting Pictures

Draw on pictures or decorate them. Shooting date decoration can also be added. Painted copies are stored as separate files.

- 1 Select the desired picture in full-frame playback mode ( 75) and tap .

The retouch menu is displayed.

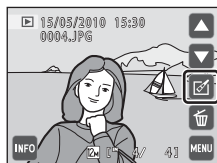



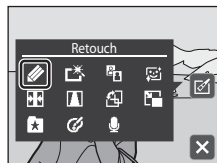



- 2 Tap .



- 3 Use the , , , and  tools to paint pictures.

For more information about using each tool, see "Write and Draw on Pictures" ( 108).

Tap  to enlarge picture display by 3x, the optimum display size for painting pictures. Tap , , , or  to change the portion of the picture in the monitor. Tap  to return to the original display size.

Tap  to undo the last operation applied using the pen, eraser, or decoration tool (up to the last five operations can be undone).

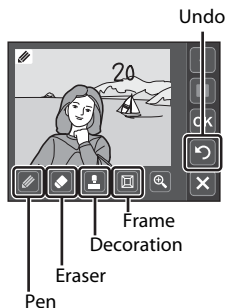

- 4 Tap .

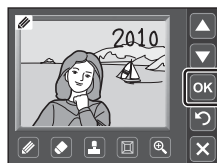

5 Tap Yes.

A new, decorated copy is created.

To exit without saving the copy, tap **No**.

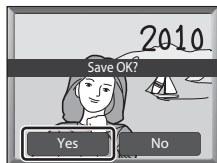
**6 Choose a size.**

Choose a copy size from **3 M** (2048 × 1536) or **TV** (640 × 480).

When pictures taken at an **Image mode** setting (📖 48) of **PC 1024×768** or **VM 640×480** are edited, or cropped copies saved at a size with a pixel count less than three million pixels are further modified using the paint function, copies are automatically saved at a size of **TV** (640 × 480).

Painted copies can be recognized by the 🖋 icon displayed during playback.

**Using the Paint Tools****Write and Draw on Pictures**

Tap 🖋 to write or draw on pictures.

- Tap the thickness control to choose the weight of pen strokes.
- Tap the color control to choose a color.

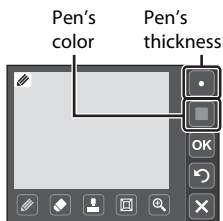
**Erase Paint Tool Additions**

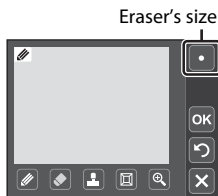

Tap 🧽 to erase additions to pictures using the paint or decoration tool.

- Tap the eraser's size control to choose the size of the eraser.



Add Decorations

Tap  to add a decoration.

- Tap the decoration type control to choose one of 14 decorations.
- Tap the decoration size control to choose the size of the decoration. When  is selected for the decoration type,  (day, month, year) and  (day, month, year, time) options are available.

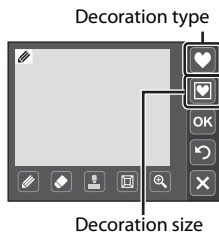



Add a Frame

Tap  to add a frame around the picture.

- Tap  or  to display seven different frames one at a time. Tap  to select a frame.



Notes on Shooting Date Decoration



- When the shooting date decoration is added to pictures taken at an **Image mode** setting ( 48) of **640x480**, the shooting date may be difficult to read. Set **Image mode** to **1024x768** or larger with shooting and select **3 M** to save the picture with the shooting date decoration.
- The date added with the shooting date decoration uses the format selected in the setup menu's **Date** item ( 141).
- The date and time added with the shooting date decoration are the date and time at which the picture was taken. These cannot be changed.

More Information

See "Image/Sound File and Folder Names" ( 162) for more information.

Quick Retouch: Enhancing Contrast and Saturation

Quick retouch can be used to easily create retouched copies in which contrast and saturation have been enhanced. Copies created with the quick retouch function are stored as separate files.

- 1 Select the desired picture in full-frame playback mode ( 75) and tap .

The retouch menu is displayed.



- 2 Tap .

The screen for selecting the degree of enhancement is displayed.

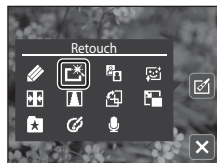

- 3 Choose the degree of enhancement performed and tap .



- 4 Tap **Yes**.

A new retouched copy is created.

To exit without saving the copy, tap **No**.

Copies created with the quick retouch option can be recognized by the  icon displayed in playback mode.

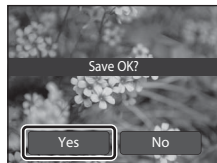

More Information

See "Image/Sound File and Folder Names" ( 162) for more information.

D-Lighting: Enhancing Brightness and Contrast

D-Lighting can be used to create copies with enhanced brightness and contrast, brightening dark portions of a picture. New copies are stored as separate files.

- 1 Select the desired picture in full-frame playback mode ( 75) and tap .

The retouch menu is displayed.



- 2 Tap .

The original version will be shown on the left and the edited version will be shown on the right.

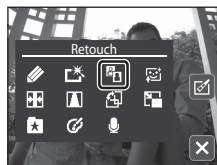

- 3 Tap .

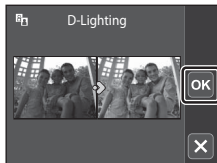

- 4 Tap **Yes**.

A new, edited copy is created.

To exit without saving the copy, tap **No**.

Copies created with the D-Lighting function can be recognized by the  icon displayed in playback mode.

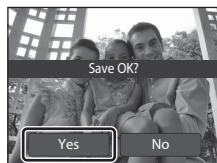

More Information

See "Image/Sound File and Folder Names" ( 162) for more information.

Skin Softening: Softening Skin Tones

The camera detects faces in pictures and creates a copy with softer facial skin tones. Copies created with the skin softening function are stored as separate files.

- 1** Select the desired picture in full-frame playback mode ( 75) and tap .

The retouch menu is displayed.



- 2** Tap .

The display for selecting the degree of enhancement to be performed is shown.

If no faces are recognized in the picture, an alert is displayed and the camera returns to full-frame playback mode.

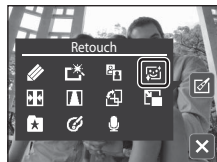

- 3** Select the degree of enhancement and tap .



The confirmation screen is displayed with the face to which skin softening was applied enlarged at the center of the monitor.

To exit without saving the copy, tap .



- 4** Check the enhancement performance.

Skin tones in up to 12 faces, in the order of that closest to the center of the frame, are softened.

If more than one face was softened, tap  or  to display a different face.

To change the degree of effect, tap  to return to step 3.

Tap  to display the confirmation dialog for saving the new copy.

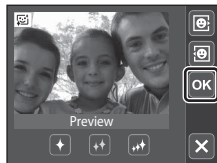

5 Tap **Yes**.

A edited copy with the skin softening function is created.

To exit without saving the copy, tap **No**.

Copies created with the skin softening function can be recognized by the  indicator displayed in playback mode.

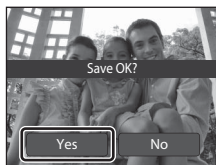

Note on Skin Softening



Depending upon the direction in which faces are looking, or the brightness of faces, the camera may be unable to accurately recognize faces, or the skin softening function may not perform as expected.

More Information

See "Image/Sound File and Folder Names" ( 162) for more information.

Stretch: Stretching Pictures

Stretch pictures horizontally. Stretched copies are stored as separate files.

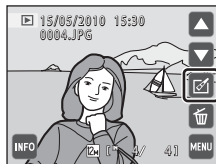

- 1 Select the desired picture in full-frame playback mode ( 75) and tap .

The retouch menu is displayed.

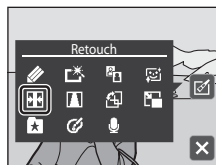

- 2 Tap .



- 3 Tap  or , or tap the slider at the bottom of the screen to adjust stretch effect.



- 4 Tap .

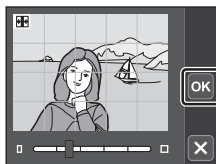

- 5 Tap **Yes**.

A new, stretched copy is created.

To exit without saving the copy, tap **No**.

Stretched copies can be recognized by the  icon displayed in playback mode.



More Information

See "Image/Sound File and Folder Names" ( 162) for more information.

Perspective Control: Adjusting a Sense of Perspective

Adjust the sense of perspective in the picture taken in landscape orientation.

Copies created with the perspective control function are stored as separate files.

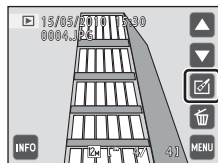

- 1 Select the desired picture in full-frame playback mode ( 75) and tap .

The retouch menu is displayed.

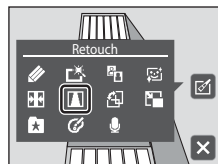

- 2 Tap .



- 3 Tap  or , or tap the slider at the bottom of the screen to adjust perspective control.

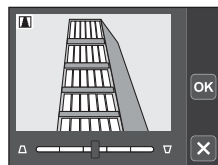

- 4 Tap .

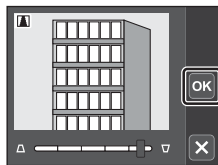

- 5 Tap **Yes**.

A new, edited copy is created.

To exit without saving the copy, tap **No**.

Copies created using the perspective control function can be recognized by the  icon displayed in playback mode.

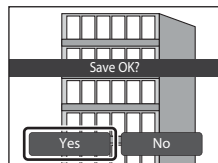

More Information

See "Image/Sound File and Folder Names" ( 162) for more information.

Small Picture: Resizing Pictures

Create a small copy of the current picture. This feature is useful for creating copies for display on Web pages or e-mail attachments. Small copies are stored as JPEG files with a compression ratio of 1:16. The  **640×480**,  **320×240**, and  **160×120** size are available.

- 1 Select the desired picture in full-frame playback mode ( 75) and tap .

The retouch menu is displayed.

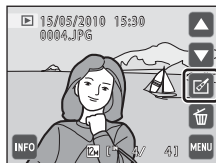

- 2 Tap .

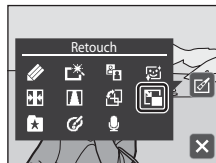

- 3 Tap the desired small copy size control and tap .

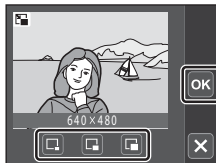

- 4 Tap **Yes**.

A new, small copy is created.

To exit without saving the copy, tap **No**.

The copy is displayed with a gray frame.

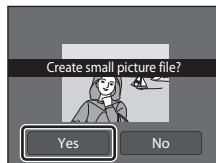







More Information

See "Image/Sound File and Folder Names" ( 162) for more information.

Color Options: Modifying Color Tones

Modify color tones. Copies created with which color tone has been modified are stored as separate files.

Options	Description
 Vivid color	Use to achieve a vivid, "photo print" effect.
 Black-and-white	Record black-and-white copies.
 Sepia	Record copies with sepia tones.
 Cyanotype	Record cyan-blue monochrome copies.

- 1 Select the desired picture in full-frame playback mode ( 75) and tap .

The retouch menu is displayed.

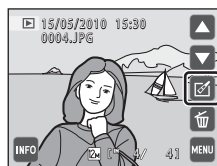

- 2 Tap .

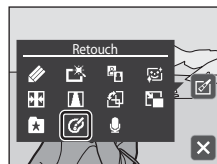

- 3 Tap the desired color option control and tap .



- 4 Tap **Yes**.

A new copy with modified color tones is created.

To exit without saving the copy, tap **No**.



Copies created using color options can be recognized by the  icon displayed in playback mode.



More Information

See "Image/Sound File and Folder Names" ( 162) for more information.

✂ Crop: Creating a Cropped Copy

Create a copy containing only the portion visible in the monitor when  is displayed with playback zoom ( 79) enabled. Cropped copies are stored as separate files.

1 Rotate the zoom control to **T** () in full-frame playback mode (75) to zoom in on the image.

To crop a picture displayed in “tall” (portrait) orientation, zoom in on the picture until the black bars displayed on the both sides of the monitor disappear. The cropped picture will be displayed in landscape orientation.

To crop the picture in its current “tall” (portrait) orientation, first rotate the picture ( 102) so that it is displayed in landscape orientation. Next, enlarge the picture for cropping, crop the picture, and then rotate the cropped picture back to “tall” (portrait) orientation.

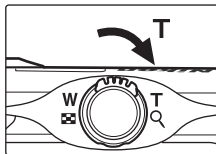

2 Refine copy composition.

Rotate the zoom control to **T** () or **W** () to adjust the zoom ratio.

Drag the picture so that only the portion to be copied is visible in the monitor.



3 Tap .





4 Tap **Yes**.

A cropped copy is created.

To exit without saving the copy, tap **No**.



Image Size



As the area to be saved is reduced, the image size (pixels) of the cropped copy is also reduced. When the size of the cropped copy is 320 × 240 or 160 × 120, a gray frame is displayed around the picture, and the small picture icon  or  is displayed on the left of the screen in full-frame playback mode.

More Information

See “Image/Sound File and Folder Names” ( 162) for more information.

Recording Movies

To shoot movies with sound recorded via the built-in microphone, select shooting mode and follow the steps below.

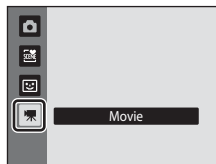

- 1 Press the  button in shooting mode to display the shooting-mode selection menu and tap .

The maximum movie length that can be recorded is displayed in the monitor ( 121). The maximum recording time for a single movie is 29 minutes. The maximum file size for a single movie is 2 GB, even when there is sufficient free space on the memory card for a larger movie file.



- 2 Press the shutter-release button all the way down to start recording.

Camera focuses on the subject at the center of the frame.

When **Movie options** ( 121) is set to  **HD 720p** (default setting), movies are recorded with the area indicated at right with an aspect ratio of 16:9.



The approximate remaining movie length is displayed.

To end recording, press the shutter-release button all the way down again.

Movie recording can also be initiated or stopped by tapping the monitor.

Recording stops automatically when the maximum movie length has been recorded.

✔ Recording Movies

- Memory cards with an SD Speed Class rating of 6 or faster are recommended when recording movies (📖 161). Movie recording may stop unexpectedly when memory cards with a lower Speed Class ratings are used.
- Optical zoom ratio cannot be adjusted once movie recording begins. Digital zoom cannot be applied before movie recording begins. However, digital zoom can be applied (up to 2x) while movies are being recorded.
- There may be some degradation in image quality when digital zoom is used.
- The angle of view (recordable area) with movie recording is narrower than with shooting of still pictures.
- The sounds of zoom control operation or autofocus lens drive movement may be recorded.
- Smear (📖 159) visible in the monitor with movie recording will be recorded with movies. Avoiding bright objects such as the sun, reflections of the sun, and electric lights when recording movies is recommended.



✔ Note on Saving Movies

After a movie has been recorded, it is not fully saved to the internal memory or memory card until monitor display returns to the shooting display. **Do not open the battery-chamber/memory card slot cover** before movies have been fully saved. Removing the memory card while movies are being saved could result in loss of data or in damage to the camera or card.

✔ Note on Autofocus

When **Single AF** (default setting) is selected for **Autofocus mode** in the movie menu, focus locks when the shutter-release button is pressed (📖 122).

✍ Functions Available with Movie Recording



- Movie recording can be initiated or stopped by tapping the monitor (touch shutter). Tap  to turn the touch shutter **ON** (default setting) or **OFF**.
- Macro mode (📖 45) is available. Confirm settings before starting movie recording. The flash (📖 42) and self-timer (📖 44) cannot be used.
- Tap  to display the  (movie) menu and **Movie options**, **Autofocus mode**, and **Electronic VR** can be enabled (📖 121).

Movie Menu



The movie menu can be used to adjust **Movie options** (📖 121), **Autofocus mode** (📖 122), and **Electronic VR** (📖 122) settings.

Switch to 🎬 (movie) shooting mode and tap  (📖 14) to display the movie menu. Tap menu items to adjust settings.



Movie Options

 (Movie) →  (Movie menu) → Movie options

The movie menu offers the options shown below.

Option	Image size and frame rate
 HD 720p (default setting)	Movies with an aspect ratio of 16:9 are recorded. This option is suited to playback on a wide screen TV. Image size: 1280 × 720 pixels Frame rate: 24 frames per second
 TV movie 640	Image size: 640 × 480 pixels Frame rate: 30 frames per second
 Small size 320	Image size: 320 × 240 pixels Frame rate: 30 frames per second

Movie Options and Maximum Movie Length

Option	Internal memory (approx. 45 MB)	Memory card * (4 GB)
 HD 720p (default setting)	18 s	28 min 50 s
 TV movie 640	30 s	46 min
 Small size 320	1 min 49 s	2 h 45 min



All figures are approximate. The maximum recording time may vary by make of memory card.

* The maximum recording time for a single movie is 29 minutes. The maximum file size for a single movie is 2 GB, even when there is sufficient free space on the memory card for a larger movie file. The maximum movie length that can be recorded for a single movie is displayed during recording.



More Information

See "Image/Sound File and Folder Names" (📖 162) for more information.



Autofocus Mode



 (Movie) →  (Movie menu) → Autofocus mode

Choose how the camera focuses with recording movies.

Option	Description
 Single AF (default setting)	Focus is locked when the shutter-release button is pressed.
 Full-time AF	Camera focuses continuously during movie recording. To prevent sound of camera focusing from interfering with recording, use of Single AF is recommended.

Electronic VR

 (Movie) →  (Movie menu) → Electronic VR

Choose whether to use electronic VR (vibration reduction) when shooting movies. This option can be enabled when **Movie options** (📖 121) is set to  **TV movie 640** or  **Small size 320**. When  **HD 720p** (default setting) is selected, the vibration reduction function is disabled and **Electronic VR** is locked at **Off**.

Option	Description
On	Reduce the effects of camera shake in all movie modes.
Off (default setting)	Disable electronic VR.

When electronic VR is enabled, its icon is displayed in the monitor (📖 11).

Movie Playback

In full-frame playback mode (📖 75), movies are recognized by the movie options icon (📖 121). Tap  to play a movie.







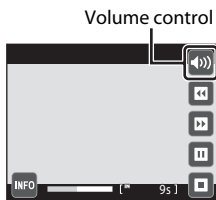









Tap the volume control during playback to display the volume setting control, and adjust playback volume. Playback controls are displayed at right in the monitor. Tap a playback control to perform the corresponding operation. The operations described below are available.

Tap  to change the information displayed in the monitor (📖 12).



During playback

To	Use	Description
Rewind		Touch and hold  to rewind movie.
Advance		Touch and hold  to advance movie.
Pause		Pause playback. The following operations can be performed while playback is paused using the controls displayed at right in the monitor.
		 Tap  to rewind movie one frame. Touch and hold  for continuous rewinding.
		 Tap  to advance movie one frame. Touch and hold  for continuous advancing.
		Resume playback.
End		Tap  to end movie playback and return to full-frame playback mode.

Deleting Movie

Select a movie in full-frame playback mode (📖 75) and tap . A confirmation dialog is displayed. Tap **Yes** to delete the movie, or tap **No** to return to the normal playback display without deleting the movie.



Movie Playback

Movies recorded by a camera other than the COOLPIX S4000 cannot be played back.

Connecting to a TV

Connect the camera to a television using the supplied audio/video cable to play back pictures full-frame or in a slide show, or to play back movies, on a television.

1 Turn off the camera.

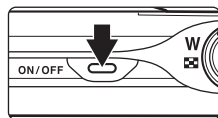

2 Connect the camera to the TV using the supplied audio/video cable.

Connect the yellow plug to the video-in jack and the white plug to the audio-in jack on the TV.

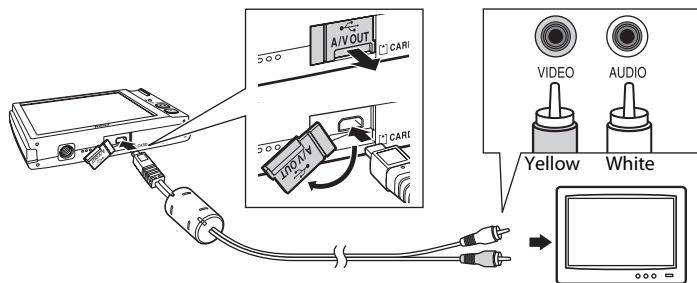

3 Tune the television to the video channel.

See the documentation provided with your television for details.

4 Hold down the button to turn on the camera.

The camera enters playback mode and pictures are displayed on the television.

The camera monitor turns off when pictures are displayed on the television.

See "Operations with TV Connection" ( 125) for more information.

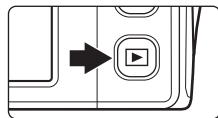

Operations with TV Connection

While pictures are displayed full-frame on the TV, the previous or subsequent picture can be viewed by dragging your finger across the camera monitor.

If the first frame of a movie is displayed, the movie can be played back by tapping the camera monitor.

- Tap the camera monitor to turn TV display off and display the picture in the camera monitor. When pictures are displayed in the camera monitor, tap the controls displayed to operate the camera.
- When the camera is connected to a TV, pictures cannot be displayed as thumbnails, picture display cannot be enlarged (playback zoom), and pictures cannot be cropped.
- Pictures will be automatically displayed on the TV in the following situations.
 - No operations are performed for a few seconds.
 - A slide show is played back.
 - A movie is played back.

Connecting the Audio/Video Cable

When connecting the audio/video cable, be sure that the camera connector is properly oriented. Do not use force when connecting the audio/video cable to the camera. When disconnecting the audio/video cable, do not pull the connector at an angle.

Video Mode

Be sure that the camera's video mode setting conforms to the standard used by your television. The video mode setting is specified from the **Video mode** (📖 151) option in the setup menu (📖 138).

Connecting to a Computer

Use the supplied USB cable to connect the camera to a computer, and copy (transfer) pictures to a computer with the supplied Nikon Transfer software.

Before Connecting the Camera

Install the Software

Before connecting the camera to a computer, software, including Nikon Transfer, ViewNX for displaying transferred pictures, and Panorama Maker for creating panorama photos, must be installed using the supplied Software Suite CD. For more information on installing the software, refer to the *Quick Start Guide*.

Compatible Operating Systems

Windows

- Windows 7 (Home Basic/Home Premium/Professional/Enterprise/Ultimate editions)
- Windows Vista Service Pack 2 (Home Basic/Home Premium/Business/Enterprise/Ultimate editions)
- 32-bit versions of Windows XP Service Pack 3 (Home Edition/Professional)

Macintosh

Mac OS X (version 10.4.11, 10.5.8, 10.6)

Refer to the Nikon website for the latest information on operating system compatibility.

Note on Computer Connection

Disconnect other USB devices such as commercial USB chargers from the computer. Simultaneous connection of the camera and other USB devices to the computer could result in operation malfunction or excessive supply of power to the camera, causing damage to the camera or memory card. Refer to the documentation supplied with other USB devices for more information.

Notes on Power Source

- When connecting the camera to a computer to transfer pictures, use a fully charged battery to prevent the camera from turning off unexpectedly.
- When the camera is connected to a computer via the supplied USB cable with **Auto** (default setting) selected for the **Charge by computer** option in the setup menu, the battery inserted into the camera is automatically charged using power supplied by the computer (📖 131, 152). Pictures can be transferred while the battery is charging.
- If the AC Adapter EH-62D (📖 160) (available separately) is used, COOLPIX S4000 can be powered from an electrical outlet. Do not use any other make or model of AC adapter as they may cause the camera to overheat or malfunction.

Transferring Pictures from a Camera to a Computer

- 1 Start the computer to which Nikon Transfer was installed.
- 2 Be sure that the camera is off.
- 3 Connect the camera to the computer using the supplied USB cable.

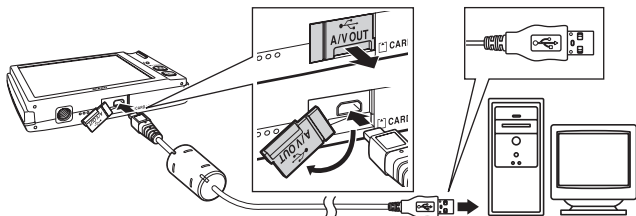

The camera is automatically turned on and the power-on lamp will light. The camera monitor will remain off.

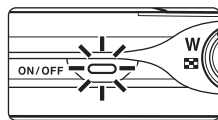

✓ Connecting the USB Cable

- Be sure that connectors are properly oriented. Do not attempt to insert connectors at an angle, and do not use force when connecting or disconnecting the USB cable.
- The connection may not be recognized if the camera is connected to the computer via a USB hub.

4 Start Nikon Transfer installed on the computer.

• Windows 7

When the **Devices and Printers ► S4000** screen is displayed, click **Change program** under **Import pictures and videos**. Select **Copy pictures to a folder on my computer** in the **Change program** dialog and click **OK**.

Double-click **Copy pictures to a folder on my computer** on the **Devices and Printers ► S4000** screen.

• Windows Vista

When the **AutoPlay** dialog is displayed, click **Copy pictures to a folder on my computer using Nikon Transfer**.

• Windows XP

When the action selection dialog is displayed, select **Nikon Transfer Copy pictures to a folder on my computer**, and click **OK**.

• Mac OS X

Nikon Transfer will start automatically when the camera is connected to the computer if **Yes** was selected in the Auto-Launch setting dialog when Nikon Transfer was first installed.

- If charge for the battery inserted into the camera is low, the computer may not recognize the camera. If the camera is not recognized, pictures will not be transferred. When battery charging starts automatically using power supplied by the computer, wait until battery charge has reached a sufficient level to begin transfer.
- If there are a large number of images on the memory card, it may take some time for Nikon Transfer to start.

5 Confirm that the source device is displayed in the transfer options **Source** panel and click **Start Transfer**.

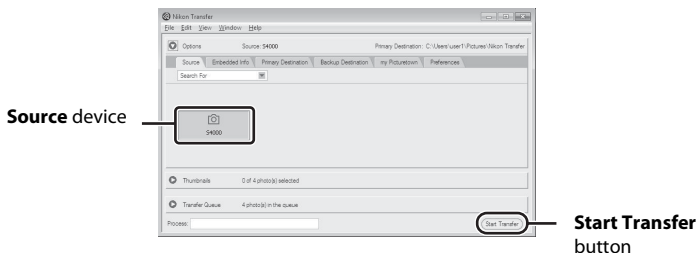

At the Nikon Transfer default settings, all pictures are transferred to the computer.

At the Nikon Transfer default settings, ViewNX starts automatically when transfer is complete and transferred pictures can be viewed.

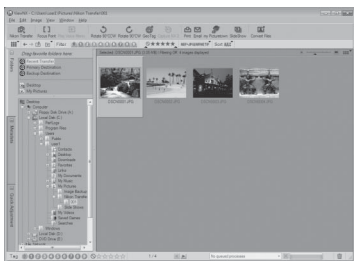

For more information on using Nikon Transfer or ViewNX, refer to help information contained in Nikon Transfer or ViewNX (📖 130).

Disconnecting the camera

Do not turn off the camera or disconnect the camera from the computer during transfer.

When transfer is complete, turn off the camera and disconnect the USB cable.

The camera turns off automatically if there is no communication with the computer for 30 minutes while the camera is connected via the USB cable.

✔ Charging the Battery

The charge lamp slowly blinks green while the battery inserted into the camera is charging (📖 131).

📄 Using a Card Reader

The pictures stored on the memory card inserted into a card reader or similar device can also be transferred to the computer using Nikon Transfer.

- If the memory card capacity is 2 GB or more, or if the memory card is SDHC-compliant, the card reader or similar device must support these memory card specifications.
- Insert a memory card into the card reader or similar device, and refer to the steps 4 and 5 (📖 128) to transfer pictures.
- To transfer pictures stored in the camera's internal memory to the computer, the pictures must first be copied to a memory card using the camera (📖 100).

Starting Nikon Transfer or ViewNX Manually

Windows

Choose **Start** menu>**All Programs**>**Nikon Transfer**>**Nikon Transfer** (or **All Programs**>**ViewNX**>**ViewNX**).

Double-clicking the Nikon Transfer or ViewNX shortcut icon on the desktop will also start Nikon Transfer or ViewNX.

Macintosh

Open **Applications** and double-click **Nikon Software**>**Nikon Transfer**>**Nikon Transfer** (or **Nikon Software**>**ViewNX**>**ViewNX**).

Clicking the Nikon Transfer or ViewNX icon on the Dock will also start Nikon Transfer or ViewNX.

Viewing Nikon Transfer and ViewNX Help Information

For more information on Nikon Transfer or ViewNX, start Nikon Transfer or ViewNX and select **Nikon Transfer Help** or **ViewNX Help** from the **Help** menu.

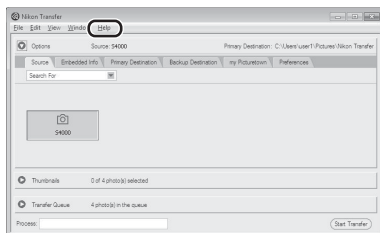

Panorama Creation with Panorama Maker

- Use a series of pictures taken in **Panorama assist** scene mode ( 70) to create a single panorama photo with Panorama Maker.
- Panorama Maker can be installed on a computer using the supplied Software Suite CD.
- After installation is complete, follow the procedure described below to start Panorama Maker.

Windows

Choose **Start** menu>**All Programs**>**ArcSoft Panorama Maker 5**>**Panorama Maker 5**.

Macintosh

Open **Applications** and double-click the **Panorama Maker 5** icon.

- For more information on using Panorama Maker, refer to the on-screen instructions and help information contained in Panorama Maker.

Image File Names and Folder Names

See "Image/Sound File and Folder Names" ( 162) for more information.

Charging While Connecting to a Computer

When connecting the camera to a computer via the supplied USB cable while **Auto** (default setting) is selected for the **Charge by computer** option (📖 152) in the setup menu, the battery inserted into the camera is automatically charged using power supplied by the computer.

See “Before Connecting the Camera” (📖 126) and “Transferring Pictures from a Camera to a Computer” (📖 127) for more information on connecting the camera to a computer.

Charge Lamp

The following chart explains charge lamp status when the camera is connected to a computer.

Charge lamp	Description
Blinks slowly (green)	Battery charging.
Off	Battery not charging. If the charge lamp changes from slow blinking (green) to off while the power-on lamp is lit, charging is complete.
Flickers (green)	<ul style="list-style-type: none"> • Charge the battery indoors with an ambient temperature of 5 °C to 35 °C (41 °F to 95 °F). • A USB cable is not correctly connected or the battery is faulty. Reconnect the USB cable correctly or replace the battery. • Computer is in sleep mode and does not supply power. Reboot a computer. • The battery cannot be charged as computer's specifications or settings does not support power supply to the camera.

✔ Notes on Charging with Connection to a Computer

- The battery cannot be charged, nor can data be transferred, when the camera is connected to a computer before the camera's date and time have been set (📖 22). If the camera's clock battery (📖 142) has been exhausted, the date and time must be reset before the battery can be charged or images can be transferred with connection to a computer. In this case, use the Charging AC Adapter EH-68P (📖 18) to charge the battery and then set the camera's date and time.
- If the camera is turned off, charging will also stop.
- If a computer enters sleep mode while charging, charging will stop and the camera may be turned off.
- When disconnecting the camera from a computer, turn the camera off and then disconnect the USB cable.
- It may take longer to charge the battery with connection to a computer than with charging using the Charging AC Adapter EH-68P. Charging time increases when images are transferred while the battery is charging.
- When the camera is connected to a computer, an application installed on the computer, such as Nikon Transfer, may start. If the camera was connected to the computer for the sole purpose of charging the battery, exit the application.
- The camera turns off automatically if there is no communication with the computer for 30 minutes after the battery has finished charging.
- Depending upon computer specifications, settings, and power supply and allocation, it may be impossible to charge the battery inserted into the camera via computer connection.

Connecting to a Printer

Users of PictBridge-compatible (📖 177) printers can connect the camera directly to the printer and print pictures without using a computer. Follow the procedures below to print pictures.

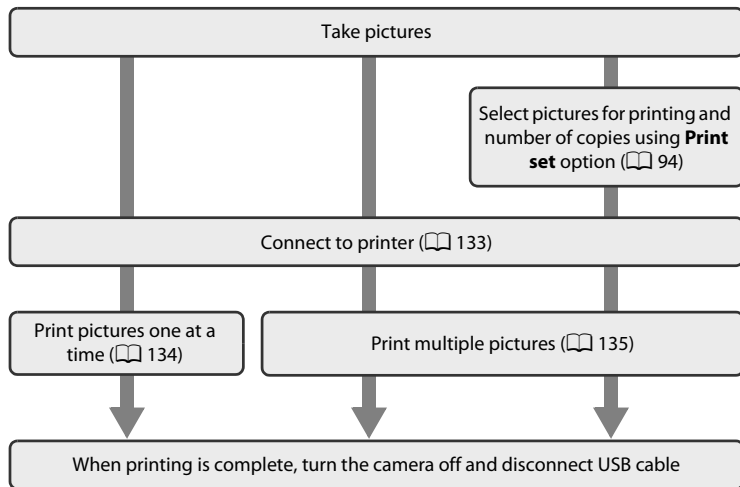

✔ **Note on Power Source**

When connecting the camera to a printer, use a fully charged battery to prevent the camera from turning off unexpectedly.

If the AC Adapter EH-62D (available separately) is used, COOLPIX S4000 can be powered from an electrical outlet. Do not use any other make or model of AC adapter as they may cause the camera to overheat or malfunction.

✔ **Note on Direct Printing**

To print pictures created in **Draw** scene mode (📖 69) over a direct camera-to-printer connection, first create a print order with **Print set** (📖 94) and then use the **DPOF printing** option (📖 137).

🔍 **Printing Pictures**

In addition to printing pictures transferred to a computer from your personal printer and printing over a direct camera-to-printer connection, the following options are also available for printing pictures:

- Inserting a memory card into a DPOF-compatible printer's card slot
- Taking a memory card to a digital photo lab

For printing using these methods, specify the pictures and the number of prints each to the memory card using the **Print set** option in the playback menu (📖 94).

Connecting the Camera to a Printer

- 1 Turn off the camera.

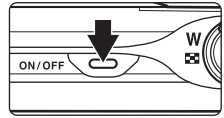

- 2 Turn on the printer.

Check printer settings.

- 3 Connect the camera to the printer using the supplied USB cable.

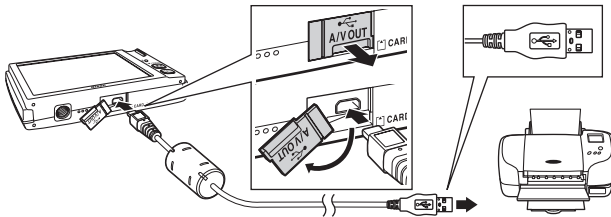

- 4 The camera automatically turns on.

When properly connected, the **PictBridge** startup screen (①) will be displayed in the camera monitor, followed by the **Print selection** screen (②).

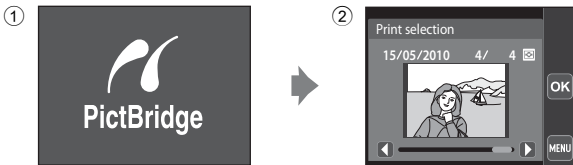
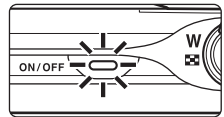

✓ Connecting the USB Cable

Be sure that connectors are properly oriented. Do not attempt to insert connectors at an angle, and do not use force when connecting or disconnecting the USB cable.

✓ If the PictBridge Screen is not Displayed

Turn the camera off and disconnect the USB cable. Set **Charge by computer** (📖 152) in the camera's setup menu to **Off** and reconnect the cable.

Printing Pictures One at a Time

After properly connecting the camera to the printer (📖 133), follow the procedure described below to print a picture.

- 1 Tap **◀** or **▶** to choose the desired picture and tap **OK**.

Previous or subsequent picture can also be viewed by tapping the scroll bar.

Tap **📐** or rotate the zoom control to **W** (**📐**) to switch to 6-thumbnail display. Tap **🔍** or rotate the zoom control to **T** (**🔍**) to switch back to full-frame playback.

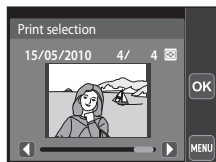

- 2 Tap **Copies**.

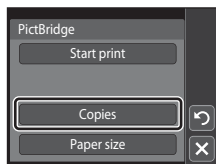

- 3 Tap the desired number of copies (up to nine).



- 4 Tap **Paper size**.

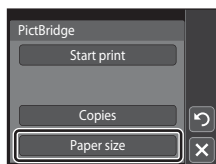

5 Tap the desired paper size.

To specify paper size using printer settings, choose **Default** in the paper size menu.

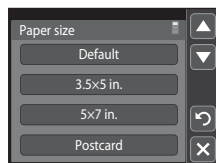
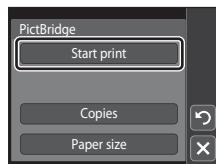
**6** Tap **Start print**.**7** Printing begins.

Monitor display returns to the print selection screen shown in step 1 when printing is complete.

To cancel printing before all copies have been printed, tap **Cancel**.

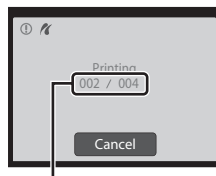

Current number of copies/
total number of prints

Printing Multiple Pictures

After properly connecting the camera to the printer (133), follow the procedure described below to print multiple pictures.

1 When the **Print selection** screen is displayed, tap **MENU**.

The **Print menu** screen is displayed.

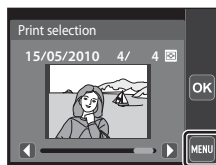
**2** Tap **Paper size**.

To exit the print menu, tap **X**.

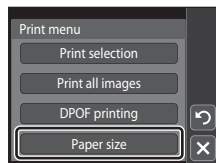

3 Tap the desired paper size.

To specify paper size using printer settings, choose **Default** in the paper size option.

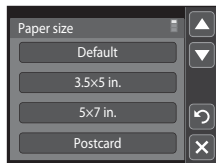
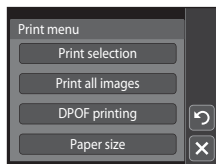
**4** Tap **Print selection**, **Print all images**, or **DPOF printing**.**Print selection**

Choose pictures (up to 99) and the number of copies (up to nine) of each.

- Tap the desired picture and tap **+** or **-** to specify the number of copies to be printed.
- Pictures selected for printing can be recognized by the check mark (✓) and the numeral indicating the number of copies to be printed. If no copies have been specified for pictures, the selection is canceled.
- Tap **Q** or rotate the zoom control to **T (Q)** to switch to full-frame playback. Tap **W** or rotate the zoom control to **W (W)** to switch back to 6-thumbnail display.
- Tap **OK** when setting is complete.
- When the screen shown at right is displayed, tap **Start print** to start printing. Tap **↺** to return to the print menu.

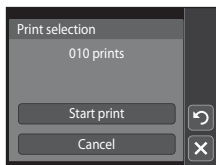
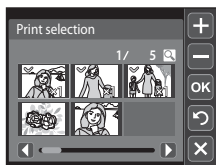



Print all images

One copy each of all pictures stored in the internal memory, or on the memory card, is printed.

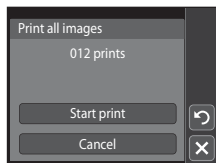
- When the screen shown at right is displayed, tap **Start print** to start printing. Tap  to return to the print menu.

**DPOF printing**

Print pictures for which a print order was created using the **Print set** option ( 94).

- When the screen shown at right is displayed, tap **Start print** to start printing. Tap  to return to the print menu.
- To view the current print order, tap **View images**. To print pictures, tap .

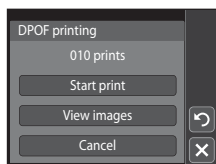
**5** Printing begins.

Monitor display returns to the print menu (step 2) when printing is complete.

To cancel printing before all copies have been printed, tap **Cancel**.

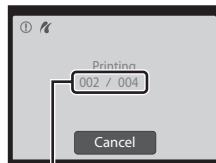















Current number of copies/
total number of prints

 **Paper Size**

The camera supports the following paper sizes: **Default** (the default paper size for the printer connected to the camera), **3.5x5 in.**, **5x7 in.**, **100x150 mm**, **4x6 in.**, **8x10 in.**, **Letter**, **A3**, and **A4**. Only sizes supported by the printer will be displayed. To specify paper size using printer settings, choose **Default** in the paper size option.

Setup Menu

The setup menu contains the following options.

Welcome screen	 140
Choose whether or not a welcome screen is displayed when camera is turned on.	
Date	 141
Set camera clock and choose home and destination time zones.	
Monitor settings	 144
Adjust photo information display and monitor brightness settings.	
Date imprint	 144
Imprint shooting date and time on pictures.	
Electronic VR	 145
Choose whether or not vibration reduction is enabled when taking still pictures.	
Motion detection	 146
Enable or disable motion detection, which reduces the effects of subject movement and camera shake in still pictures.	
AF assist	 147
Enable or disable AF-assist illuminator.	
Digital zoom	 148
Enable or disable digital zoom.	
Sound settings	 148
Adjust sound settings.	
Auto off	 149
Set time before camera enters standby mode for saving power.	
Format memory/Format card	 150
Format internal memory or memory card.	
Language	 151
Choose the language used for camera monitor display.	
Video mode	 151
Adjust settings necessary for connection to television.	
Charge by computer	 152
Choose whether or not to charge the camera battery when connecting to a computer via the USB cable.	
Blink warning	 152
Specify whether or not the camera detects human subjects that have blinked with shooting using face priority.	

Reset all

📖 154

Restore camera settings to default values.

Firmware version

📖 156

Display camera firmware version.

Displaying the Setup Menu

- 1 Tap **MENU** to display the menu screen.

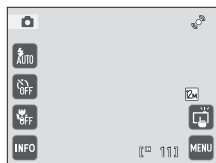



- 2 Tap the **Y** tab.



Setup menu items can be accessed.

Tap **X**, or another tab, to exit the setup menu.

Welcome Screen

Tap  →  (Setup menu) ( 139) → Welcome screen

Choose whether or not a welcome screen is displayed when the camera is turned on.

None (default setting)





The camera enters shooting or playback mode without displaying the welcome screen.

COOLPIX

The camera displays a welcome screen and enters shooting or playback mode.

Select an image

Displays a picture selected for the welcome screen. When the picture selection screen is displayed, select a picture ( 99) and tap .

- As the selected picture is stored by the camera, it will be displayed when the camera is turned on even if the original picture is deleted.
- Pictures taken at an **Image mode** setting ( 48) of  **3968×2232**, and copies created at a size of 320 × 240 or smaller using small picture ( 116) or the crop ( 118) function, cannot be used.

Date





Tap  →  (Setup menu) ( 139) → Date

Set the camera clock.



Date

Set camera clock to current date and time.

Tap an item (the order in which day, month and year are displayed, day, month, year, hour, or minute) in the date screen.

- Edit the highlighted item: tap  or .
- Apply the setting: tap  ( 23).

Time zone

 **Home time zone** can be specified and daylight saving is enabled or disabled from **Time zone** options. When the destination time zone () is selected, local time ( 143) is automatically calculated and the date and time in the selected region are recorded with pictures. Useful when traveling.

Selecting Travel Destination Time Zone

1 Tap **Time zone**.

The **Time zone** menu is displayed.

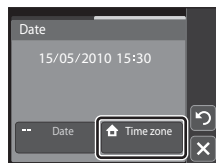

2 Tap **Travel destination**.

The date and time displayed in the monitor changes according to the region currently selected.

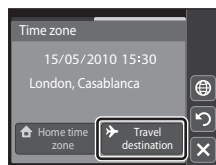

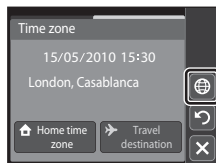

3 Tap .

The time zone selection screen is displayed.



4 Tap or to choose the travel destination time zone and tap **OK**.

If daylight saving time is in effect, tap  to enable daylight saving time function.  is displayed at the top of the monitor and the camera clock is advanced one hour. Tapping  again to disable the daylight saving time function.





While the travel destination time zone is selected, the  icon will be displayed in the monitor when the camera is in shooting mode.

Note on the Clock Battery

The camera clock is powered by the clock battery. The clock battery charges when the main battery is inserted or an AC adapter is connected, and can provide several days of backup power after about ten hours of charging.

Home Time Zone

- To switch to the home time zone, tap  **Home time zone** in step 2.
- To change the home time zone, tap  **Home time zone** in step 2 and complete steps 3 and 4.

Daylight Saving Time

When daylight saving time starts or ends, turn the daylight saving time option on or off from the time zone selection screen displayed in step 4.

Imprinting Date on Pictures

Enable date imprint from the **Date imprint** option ( 144) in the setup menu after the date and time have been set. When the **Date imprint** option is enabled, pictures will be recorded with shooting date imprinted on them.



 **Time Zones**

The camera supports the time zones listed below.

For time zones not listed below, set the camera clock to local time from the **Date** option.

UTC +/-	Location	UTC +/-	Location
-11	Midway, Samoa	+1	Madrid, Paris, Berlin
-10	Hawaii, Tahiti	+2	Athens, Helsinki, Ankara
-9	Alaska, Anchorage	+3	Moscow, Nairobi, Riyadh, Kuwait, Manama
-8	PST (PDT): Los Angeles, Seattle, Vancouver	+4	Abu Dhabi, Dubai
-7	MST (MDT): Denver, Phoenix	+5	Islamabad, Karachi
-6	CST (CDT): Chicago, Houston, Mexico City	+5.5	New Delhi
-5	EST (EDT): New York, Toronto, Lima	+6	Colombo, Dhaka
-4.5	Caracas	+7	Bangkok, Jakarta
-4	Manaus	+8	Beijing, Hong Kong, Singapore
-3	Buenos Aires, Sao Paulo	+9	Tokyo, Seoul
-2	Fernando de Noronha	+10	Sydney, Guam
-1	Azores	+11	New Caledonia
±0	London, Casablanca	+12	Auckland, Fiji

Monitor Settings

Tap  →  (Setup menu) ( 139) → Monitor settings

Set the options below.

Image review



On (default setting): Picture is automatically displayed in the monitor immediately after it is taken and the monitor display returns to shooting mode.

Off: Picture is not displayed after it is taken.

Brightness

Choose from five settings for monitor brightness. The default setting is **3**.

Date Imprint (Imprinting Date and Time)

Tap  →  (Setup menu) ( 139) → Date imprint

The shooting date and time can be imprinted on the pictures with shooting, allowing the information to be printed even from printers that do not support date printing ( 95).



Off (default setting)

Date and time are not imprinted on pictures.



Date

Date is imprinted on pictures.



Date and time

Date and time are imprinted on pictures.

At settings other than **Off**, the icon for the current setting is displayed in the monitor ( 11).



✓ Notes on Date Imprint

- Imprinted dates form a permanent part of image data and cannot be deleted. The date and time cannot be imprinted on pictures after they have been taken.
- The date is not imprinted in the following situations:
 - Pictures taken in **Panorama assist** scene mode
 - Movies
- Dates imprinted at an **Image mode** setting (📖 48) of **VR 640×480** may be difficult to read. Choose an **Image mode** setting of **PC 1024×768** or larger when using date imprint.
- The date is recorded using the format selected in the setup menu's **Date** item (📖 22, 141).

📎 Date Imprint and Print Set

When printing from DPOF-compatible printers that support the printing of shooting date and photo information, the date and information can be printed without imprinting this information on them, using settings in the **Print set** option (📖 94).

Electronic VR

Tap  →  (Setup menu) (📖 139) → Electronic VR

Choose whether or not electronic VR (vibration reduction) is used when taking still pictures.

Auto

Electronic VR is enabled and the effects of camera shake are reduced with shooting of still pictures when all of the following conditions are met.

- The flash is turned off or set to slow sync mode.
- A slow shutter speed is used.
- The **Continuous** setting is set to **Single**.
- The subject is dark.

Off (default setting)

Electronic VR is disabled.

When **Auto** is selected,  is displayed in the monitor (📖 11), and electronic VR is applied according to shooting conditions.

✓ Notes on Electronic Vibration Reduction

- Electronic VR does not function when the flash is used, except when slow sync mode is applied. Electronic VR does not function when slow sync with red-eye reduction (📖 63, 64) is used.
- Electronic VR does not function with exposures that exceed a certain length of time.
- Electronic VR is activated only when **ISO sensitivity** (📖 54) is set to **Auto**.
- Electronic VR does not function in the following scene modes.
 - **Sports** (📖 63)
 - **Night portrait** (📖 63)
 - **Dusk/dawn** (📖 65)
 - **Night landscape** (📖 65)
 - **Museum** (📖 66)
 - **Fireworks show** (📖 67)
 - **Backlight** (📖 67)
- Electronic VR does not function when **Blink proof** (📖 74) is set to **On**.
- The effectiveness of electronic VR decreases as camera shake increases.
- The pictures taken using electronic vibration reduction may be somewhat "grainy" in appearance.

🎬 Electronic VR for Movies

To compensate for camera shake with movie recording, enable **Electronic VR** (📖 122) from the movie menu (📖 121).

Motion Detection

Tap **MENU** → 🎬 (Setup menu) (📖 139) → Motion detection

Enable motion detection to reduce the effects of subject movement and camera shake when shooting still pictures.

Auto (default setting)

When the camera detects the subject movement or camera shake, the ISO sensitivity and shutter speed are automatically increased to reduce blurring. However, motion detection does not function in the following situations.

- **Subject tracking** is selected for the touch shooting setting
- When the flash fires
- When **ISO sensitivity** (📖 54) is set to **Fixed range auto**, or ISO sensitivity is fixed at a particular value in 🎬 (auto) mode
- When **Multi-shot 16** (📖 53) is selected
- When **Sports** (📖 63), **Night portrait** (📖 63), **Dusk/dawn** (📖 65), **Fireworks show** (📖 67), or **Backlight** (📖 67) scene mode is enabled
- When recording movies

Off



Motion detection is not enabled.

The current motion detection setting can be confirmed in the camera monitor with shooting (📖 11, 27). The motion detection icon turns green when the camera detects camera shake and increases shutter speed. When **Off** is selected, no icon is displayed.

✔ Notes on Motion Detection

- Motion detection may be unable to completely eliminate the effects of subject movement and camera shake in some situations.
- Motion detection may not function if the subject exhibits significant movement or is too dark.
- The pictures taken using motion detection may be somewhat “grainy” in appearance.

AF Assist

Tap  →  (Setup menu) (📖 139) → AF assist

Enable or disable AF-assist illumination, which assists autofocus operation when the subject is dimly lit.



Auto (default setting)

AF-assist illumination will be used to assist the focus operation when the subject is dimly lit. The illuminator has a range of about 1.9 m (6 ft. 2 in.) at the maximum wide-angle position and about 1.1 m (3 ft. 7 in.) at the maximum telephoto position. Note that for some scene modes or focus areas, AF-assist illuminator may not light.

Off

AF-assist illuminator does not light. The camera may be unable to focus under dim lighting.

Digital Zoom

Tap  →  (Setup menu) (📖 139) → Digital zoom

Enable or disable digital zoom.

On (default setting)

When the camera is zoomed in to the maximum optical zoom position, rotating the zoom control to **T** (📖) triggers digital zoom (📖 29).



Off

Digital zoom will not be activated (except when shooting movies).

✔ Notes on Digital Zoom

- When digital zoom is in effect, **AF area mode** is set to **Center** (📖 55).
- Digital zoom cannot be used in the following situations.
 - **Subject tracking** is selected for the touch shooting setting
 - When **Scene auto selector**, **Portrait**, or **Night portrait** is selected in scene mode
 - When smart portrait mode is selected
 - When **Multi-shot 16** (📖 53) is selected
 - Just before recording a movie (up to 2x zoom can be activated while recording movies)

Sound Settings

Tap  →  (Setup menu) (📖 139) → Sound settings

Adjust the following sound settings.

Button sound

Select **On** (default setting) or **Off**.



When **On** is selected, a beep will sound once when operations are completed successfully, twice when the camera acquires focus on the subject, and three times when an error is detected. Start-up sound will also play when the camera is turned on.

Shutter sound

Select **On** (default setting) or **Off**.

No sound is played with shutter release when some features such as continuous shooting or BSS (best shot selector) are enabled, or when recording movies, even if **On** is selected.

Auto Off

Tap  →  (Setup menu) ( 139) → Auto off

When the camera is on and a period of time passes without any operations having been performed, the monitor will be turned off and the camera will enter standby mode ( 21) to save power. Once the camera has entered standby mode, the power-on lamp will blink, and if no operations are performed for another three minutes, the camera will turn off.

Choose the time allowed to elapse before the camera enters standby mode if no operations are performed from **30 s**, **1 min** (default setting), **5 min**, and **30 min**.

Canceling Standby Mode

Cancel standby mode and reactivate the monitor by pressing any of the following buttons.



- the power switch
- the shutter-release button
- the  button
- the  button

Note on Auto Off

The time allowed to elapse before the camera enters standby mode is fixed in the following situations:

- When a menu is displayed: three minutes
- During slide show playback: up to 30 minutes
- When the AC adapter EH-62D is connected: 30 minutes

Format Memory/Format Card

Tap  →  (Setup menu)  139 → Format memory/ Format card

Use this option to format the internal memory or a memory card.

Formatting the Internal Memory

To format the internal memory, remove the memory card from the camera.

The **Format memory** option is displayed in the setup menu.

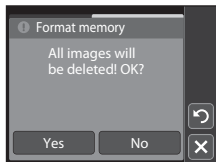

Formatting a Memory Card

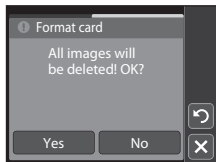

When a memory card is inserted in the camera, the **Format card** option is displayed in the setup menu.



Formatting Internal Memory and Memory Cards

- **Formatting the internal memory or memory cards permanently deletes all data.** Be sure to transfer important pictures to a computer before formatting.
- Formatting the internal memory or memory card restores album icon settings ( 86) to the default setting (displayed as number).
- Do not turn the camera off or open the battery-chamber/memory card slot cover during formatting.
- Be sure to use this camera to format memory cards previously used in other devices the first time they are inserted into the COOLPIX S4000.

Language



Tap  →  (Setup menu) (📖 139) → Language

Choose one of 24 languages for display of camera menus and messages.

Čeština	Czech
Dansk	Danish
Deutsch	German
English	(default setting)
Español	Spanish
Ελληνικά	Greek
Français	French
Indonesia	Indonesian
Italiano	Italian
Magyar	Hungarian
Nederlands	Dutch
Norsk	Norwegian

Polski	Polish
Português	Portuguese
Русский	Russian
Suomi	Finnish
Svenska	Swedish
Türkçe	Turkish
简体中文	Simplified Chinese
繁體中文	Traditional Chinese
日本語	Japanese
한글	Korean
ภาษาไทย	Thai
عربي	Arabic

Video Mode

Tap  →  (Setup menu) (📖 139) → Video mode

Adjust settings for connection to a television. Choose from **NTSC** and **PAL**.

Charge by Computer

Tap  →  (Setup menu) (📖 139) → Charge by computer

Choose whether or not the battery inserted into the camera is charged when the camera is connected to a computer via the USB cable (📖 131).

Auto (default setting)

When the camera is connected to a computer that is running, the battery inserted into the camera is automatically charged using power supplied by the computer.



Off

The battery inserted into the camera is not charged when the camera is connected to a computer.

✓ Notes on Connecting the Camera to a Printer

- The battery cannot be charged with connection to a printer, even if the printer complies with the PictBridge standard.
- When **Auto** is selected for **Charge by computer**, it may be impossible to print pictures with direct connection of the camera to some printers. If the **PictBridge** startup screen is not displayed in the monitor after the camera is connected to a printer and turned on, turn the camera off and disconnect the USB cable. Set **Charge by computer** to **Off** and reconnect the camera to the printer.

Blink Warning

Tap  →  (Setup menu) (📖 139) → Blink warning

Specify whether or not the camera detects human subjects that have blinked using face priority (📖 56) when shooting in the following modes.

-  (auto) mode (when **Face priority** (📖 55) is selected for AF area mode option).
- **Scene auto selector** (📖 60), **Portrait** (📖 62), or **Night portrait** (📖 63) is selected for the scene mode.

On

When the camera detects that one or more human subjects may have blinked in a picture taken using face priority, the blink warning screen is displayed in the monitor. The face of the human subject that may have blinked when the shutter was released is framed by a yellow border. Should this occur, check the picture and determine whether or not another picture should be taken. See "Operating the Blink Warning Screen" (📖 153) for more information.

Off (default setting)

Blink warning is not enabled.

Operating the Blink Warning Screen

When the blink warning screen shown at right is displayed in the monitor, the operations described below are available.

If no operations are performed within a few seconds, the camera automatically returns to shooting mode.



To	Use	Description
Enlarge the detected face that blinked	T (Q)	Rotate the zoom control to T (Q). If the camera detects that more than one human subject blinked, tap or to switch display to another face.
Switch to full-frame playback	W (checkered flag)	Rotate the zoom control to W (checkered flag).
Delete the picture		Tap .
Switch to shooting mode	OK	Tap the monitor, OK , or X . The shutter-release button can also be pressed to return to shooting mode.
	X	

Note on Blink Warning

The blink warning does not function at continuous settings of **Continuous**, **BSS**, or **Multi-shot 16**.

Reset All

Tap  →  (Setup menu) (📖 139) → Reset all

When **Reset** is selected, the camera's settings will be restored to their default values.

Basic Shooting Functions

Option	Default value
Touch shooting (📖 34, 37, 40)	Touch shutter
Flash mode (📖 42)	Auto
Self-timer (📖 44)	Off
Macro mode (📖 45)	Off

Shooting Menu

Option	Default value
Image mode (📖 48)	 4000×3000
White balance (📖 50)	Auto
Exposure comp. (📖 52)	0.0
Continuous (📖 53)	Single
ISO sensitivity (📖 54)	Auto
AF area mode (📖 55)	Face priority
Autofocus mode (📖 57)	Single AF

Scene Mode

Option	Default value
Scene mode setting in the shooting-mode selection menu (📖 59)	Scene auto selector
Hue adjustment in Food mode (📖 66)	Center

Smart portrait Menu

Option	Default value
Skin softening (📖 74)	Normal
Smile timer (📖 74)	On
Blink proof (📖 74)	Off

Movie Menu

Option	Default value
Movie options (📖 121)	 HD 720p
Autofocus mode (📖 122)	Single AF
Electronic VR (📖 122)	Off

Setup Menu

Option	Default value
Welcome screen (📖 140)	None
Image review (📖 144)	On
Brightness (📖 144)	3
Date imprint (📖 144)	Off
Electronic VR (📖 145)	Off
Motion detection (📖 146)	Auto
AF assist (📖 147)	Auto
Digital zoom (📖 148)	On
Button sound (📖 148)	On
Shutter sound (📖 148)	On
Auto off (📖 149)	1 min
Charge by computer (📖 152)	Auto
Blink warning (📖 152)	Off

Others

Option	Default value
Paper size (📖 134, 135)	Default
Frame interval for Slide show (📖 97)	3 s

Setup Menu

- Selecting **Reset** also clears the current file number (📖 162) from memory. Numbering will continue from the lowest number available. To reset file numbering to “0001”, delete all pictures stored in the internal memory or on the memory card (📖 98) before selecting **Reset**.
- The following menu settings will remain unaffected when menus are reset with **Reset all**.
Shooting menu: Preset manual data (📖 51) acquired for **White balance**
Setup menu: Picture selected for **Welcome screen** (📖 140), **Date** (📖 141), **Language** (📖 151), and **Video mode** (📖 151)

Firmware Version

Tap **MENU** → 📏 (Setup menu) (📖 139) → Firmware version

View the current camera firmware version.



Maximizing Camera Life and Performance

To ensure continued enjoyment of this Nikon product, observe the following precautions when using or storing the device.

Keep dry

The device will be damaged if immersed in water or subjected to high humidity.

Do not drop

The product may malfunction if subjected to strong shock or vibration.

Handle the lens and all moving parts with care

Do not apply force to the lens, lens cover, monitor, memory card slot or battery chamber. These parts are easily damaged. Applying force to the lens cover could result in camera malfunction or damage to the lens. Should the monitor break, care should be taken to avoid injury caused by broken glass and to prevent the liquid crystal from the display touching the skin or entering the eyes or mouth.

Do not point the lens at strong light sources for extended periods

Avoid pointing the lens at the sun or other strong light sources for extended periods when using or storing the camera. Intense light may cause deterioration of the CCD image sensor, producing a white blur effect in photographs.

Keep away from strong magnetic fields

Do not use or store this device in the vicinity of equipment that generates strong electromagnetic radiation or magnetic fields. Strong static charge or the magnetic fields produced by equipment such as radio transmitters could interfere with the monitor, damage data stored on the memory card, or affect the product's internal circuitry.

Avoid sudden changes in temperature

Sudden changes in temperature, such as when entering or leaving a heated building on a cold day, can cause condensation to form inside the device. To prevent condensation, place the device in a carrying case or a plastic bag before exposing it to sudden changes in temperature.

Turn the product off before removing or disconnecting the power source

Do not remove the battery while the product is on, or while images are being recorded or deleted. Forcibly cutting power in these circumstances could result in loss of data or in damage to product memory or internal circuitry.

The Battery

- Check the battery level before using the camera and replace or charge the battery if necessary. Do not continue charging once the battery is fully charged as this will result in reduced battery performance. Whenever possible, carry a fully charged spare battery when taking pictures on important occasions.
- Do not use the battery at ambient temperatures below 0 °C (32 °F) or above 40 °C (104 °F).
- Charge the battery indoors with an ambient temperature of 5 °C to 35 °C (41 °F to 95 °F) before use.
- When charging the COOLPIX S4000 using the Charging AC adapter EH-68P or a computer, the battery is not charged at ambient temperatures below 0 °C (32 °F) or above 45 °C (113 °F).
- Note that the battery may become hot during use; wait for the battery to cool before charging. Failure to observe these precautions could damage the battery, impair its performance, or prevent it from charging normally.
- On cold days, the capacity of batteries tends to decrease. Be sure that the battery is fully charged before heading outside to take pictures in cold weather. Keep spare batteries in a warm place and exchange as necessary. Once warmed, a cold battery may recover some of its charge.
- Dirt on the battery terminals can prevent the camera from functioning. Should the battery terminals become dirty, wipe them off with a clean, dry cloth before use.
- If the battery will not be used for some time, insert it in the camera and run it flat before removing it for storage. The battery should be stored in a cool location with an ambient temperature of 15 to 25 °C (59 to 77 °F). Do not store the battery in hot or extremely cold locations.
- Always remove the battery from the camera or optional battery charger when it is not being used. When inserted, minute amounts of current are drawn from the battery even when not in use. This may result in excessive draining of the battery and complete loss of function. Turning the camera on or off while the battery is exhausted can result in reduced battery life.
- Recharge the battery at least once every six months and completely exhaust it before returning it to storage.
- After removing the battery from the camera or optional battery charger, return the battery to the battery case and store in a cool place.
- A marked drop in the time a fully-charged battery retains its charge, when used at room temperature, indicates that the battery needs to be replaced. Purchase a new EN-EL10 battery.
- Replace the battery when it no longer holds a charge. Used batteries are a valuable resource. Please recycle used batteries in accordance with local regulations.

Cleaning

Lens	Avoid touching glass parts with your fingers. Remove dust or lint with a blower (typically a small device with a rubber bulb attached to one end that is pumped to produce a stream of air out the other end). To remove fingerprints or other stains that cannot be removed with a blower, wipe the lens with a soft cloth, using a spiral motion that starts at the center of the lens and working toward the edges. If this fails, clean the lens using a cloth lightly dampened with commercial lens cleaner.
Monitor	Remove dust or lint with a blower. To remove fingerprints and other stains, clean the monitor with a soft, dry cloth, being careful not to apply pressure.
Body	Use a blower to remove dust, dirt or sand, then wipe gently with a soft, dry cloth. After using the camera at the beach or other sandy or dusty environment, wipe off any sand, dust, or salt with a dry cloth lightly dampened with fresh water and dry thoroughly. Note that foreign matter inside the camera could cause damage not covered by the warranty.

Do not use alcohol, thinner, or other volatile chemicals.

Storage

Turn the camera off when not in use. Be sure that the power-on lamp is off before putting the camera away. Remove the battery if the camera will not be used for an extended period. Do not store the camera with naphtha or camphor moth balls, or in any of the following locations:

- Next to equipment that produces strong electromagnetic fields, such as televisions or radios
- Exposed to temperatures below -10°C (14°F) or above 50°C (122°F)
- Places that are poorly ventilated or subject to humidity of over 60%

To prevent mold or mildew, take the camera out of storage at least once a month. Turn the camera on and release the shutter a few times before putting the camera away again.

Notes on the Monitor

- The monitor may contain a few pixels that are always lit or that do not light. This is a characteristic common to all TFT LCD displays, and does not indicate a malfunction. Images recorded using the product will not be affected.
- White or colored streaks may be visible when bright subjects are framed in the monitor. This phenomenon, known as “smear,” occurs when extremely bright light strikes the image sensor; it is characteristic of image sensors and does not indicate a malfunction. Smear may also take the form of partial discoloration in the monitor during shooting. It does not appear in images recorded with the camera except in the cases of movies and of images recorded with **Multi-shot 16** selected for **Continuous**. When shooting in these modes, we recommend that you avoid bright subjects such as the sun, reflected sunlight, and electric lights.
- Images in the monitor may be difficult to see under bright lighting.
- The monitor is lit by an LED backlight. Should the monitor begin to dim or flicker, contact your Nikon-authorized service representative.

Optional Accessories

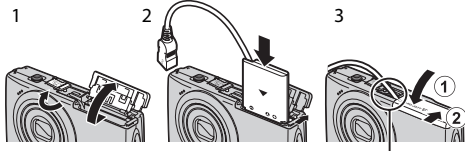
Rechargeable battery	Rechargeable Li-ion Battery EN-EL10
Charging AC Adapter	Charging AC Adapter EH-68P*, EH-68P (AR)*
Battery charger	Battery Charger MH-63
AC adapter	<p>AC Adapter EH-62D</p> <p>Connecting the EH-62D</p>  <p>Check that the AC adapter cord has been inserted correctly into the battery chamber before closing the battery-chamber/memory card slot cover. If part of the cord has not been inserted into the chamber the cover may be damaged during closure.</p>
USB cable	USB Cable UC-E6
Audio/video cable	Audio Video Cable EG-CP14

* When using in other countries, use a plug adapter (available commercially) as necessary. For more information about plug adapters, consult your travel agency.

Approved Memory Cards

The following Secure Digital (SD) memory cards have been tested and approved for use in this camera.

Memory cards with an SD Speed Class¹ rating of 6 or faster are recommended for recording movies. Movie recording may stop unexpectedly when memory cards with a lower Speed Class rating are used.

SanDisk	2 GB ² , 4 GB ³ , 8 GB ³ , 16 GB ³ , 32 GB ³
TOSHIBA	2 GB ² , 4 GB ³ , 8 GB ³ , 16 GB ³ , 32 GB ³
Panasonic	2 GB ² , 4 GB ³ , 8 GB ³ , 12 GB ³ , 16 GB ³ , 32 GB ³
Lexar	2 GB ² , 4 GB ³ , 8 GB ³

¹ Specification defining minimum data transfer speeds for SD and SDHC memory cards.

² If the memory card will be used with a card reader or similar device, be sure that the device supports 2 GB cards.

³  SDHC compliant.

If the memory card will be used with a card reader or similar device, be sure that the device is SDHC compliant.

Contact the manufacturer for details on the above cards.

Image/Sound File and Folder Names



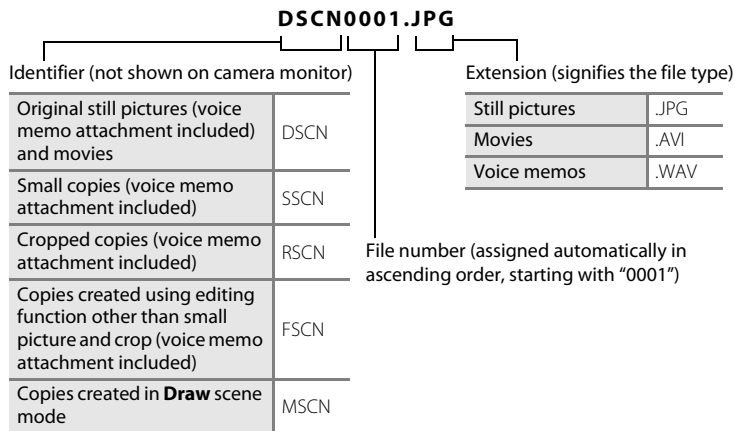







Pictures, movies, or voice memos are assigned file names as follows.









- Files are stored in folders named with a folder number followed by an identifier: "P_" plus a three-digit sequence number for pictures taken using **Panorama assist** scene mode (e.g. "101P_001"; 📖 70) and "NIKON" for all other pictures (e.g. "100NIKON"). When the number of files within a folder reaches 9999, a new folder will be created. File numbers will be assigned automatically starting with "0001."
- Voice memo file names have the same identifier and file number as the picture to which the voice memo is attached.
- Files copied using **Copy>Selected images** are copied to the current folder, where they are assigned new file numbers in ascending order starting from the largest file number in memory. **Copy>All images** copies all folders from the source medium; file names do not change but new folder numbers are assigned in ascending order, starting from the largest folder number on the destination medium (📖 100).
- A single folder can hold up to 200 pictures; if the current folder already contains 200 pictures, a new folder, named by adding one to the current folder name, will be created the next time a picture is taken. If the current folder is numbered 999 and contains 200 pictures, or a picture is numbered 9999, no further pictures can be taken until the internal memory or memory card is formatted (📖 150), or a new memory card is inserted.











Error Messages

The following table lists the error messages and other warnings displayed in the monitor, as well as the solutions for dealing with them.











Display	Problem	Solution	
 (blinks)	Clock not set.	Set date and time.	141
	Battery running low.	Prepare to charge or replace battery.	16, 18
 Battery exhausted.	Battery exhausted.	Charge or change battery.	16, 18
 Battery temperature high	Battery temperature is high.	Turn off camera, and allow battery to cool down before resuming use. After five seconds, this message will disappear, the monitor will turn off, and the power-on lamp will blink rapidly. After the lamps blink for three minutes, the camera will turn off automatically. Pressing the power switch also turns off the camera.	21
 ● (● blinks red)	Camera cannot focus.	<ul style="list-style-type: none"> • Refocus. • Focus on another subject positioned at the same distance from the camera as the intended subject. 	30, 31 39
 Please wait for the camera to finish recording.	Camera cannot perform other operations until recording is complete.	Wait until message clears from display automatically when recording is complete.	–
 Memory card is write protected.	Write-protect switch is in “lock” position.	Slide write-protect switch to “write” position.	25
 This card cannot be used.	Error accessing memory card.	<ul style="list-style-type: none"> • Use approved card. • Check that connectors are clean. • Confirm that memory card is correctly inserted. 	161 24
 This card cannot be read.			24

Error Messages

Display	Problem	Solution	
<p> Card is not formatted. Format card? Yes No</p>	Memory card has not been formatted for use in COOLPIX S4000.	Formatting deletes all data stored on the memory card. Be sure to tap No and make copies of any pictures which need to be kept before formatting the memory card. Tap Yes to format the memory card.	25
<p> Out of memory.</p>	Memory card is full.	<ul style="list-style-type: none"> Choose smaller image size. Delete pictures. Insert new memory card. Remove memory card and use internal memory. 	48 33, 98, 123 24 24
<p> Image cannot be saved.</p>	Error occurred while recording picture.	Format internal memory or memory card.	150
	Camera has run out of file numbers.	Insert new memory card or format internal memory or memory card.	162
	Picture cannot be used for welcome screen.	<p>The following pictures cannot be registered as welcome screen.</p> <ul style="list-style-type: none"> Pictures taken at an Image mode setting of  3968x2232 Pictures reduced to 320 x 240 size or smaller with cropping or small picture editing 	140
	Insufficient space to save a copy.	Delete pictures from destination.	98
<p> Album is full. No further pictures can be added.</p>	Over 200 pictures have already been added to album.	<ul style="list-style-type: none"> Remove some pictures from album. Add to other albums. 	84 81
<p> A blink was detected in the picture just taken.</p>	One or more portrait subjects may have blinked when the picture was taken.	Check the picture in playback mode.	74, 75

Display	Problem	Solution	
 Image cannot be modified.	Cannot edit selected picture.	<ul style="list-style-type: none"> Select pictures that support editing function. Movies cannot be edited. 	105 –
 Cannot record movie.	Time out error while recording movie.	Choose memory card with faster write speed.	24
 Memory contains no images.	No pictures in the internal memory or memory card.	<ul style="list-style-type: none"> Remove the memory card from the camera to play back pictures stored in the camera's internal memory. To copy picture from internal memory to memory card, tap . The copy screen will be displayed and pictures in the internal memory can be copied to memory card. 	24 100
			The picture has not been added to album.
	No pictures are contained in the category selected in auto sort mode.	Select the category containing the sorted pictures.	89
	 File contains no image data.	File not created with this camera.	File cannot be viewed on this camera. View file using a computer or the device used to create or edit this file.
 This file cannot be played back.			
 All images are hidden.	No pictures are available for a slide show.	–	97
 This image cannot be deleted.	Picture is protected.	Disable protection.	100
 Travel destination is in the current time zone.	Destination in same time zone as home.	–	143

Error Messages





Display	Problem	Solution	
Lens error 	Lens error.	Turn camera off and then on again. If error persists, contact retailer or Nikon-authorized service representative.	26
 Communications error	USB cable disconnected during data transfer to printer.	Turn camera off and reconnect cable.	133
System error 	Error has occurred in camera's internal circuitry.	Turn camera off, remove and reinsert battery, and turn camera on. If error persists, contact retailer or Nikon-authorized service representative.	17, 21
 Printer error: check printer status.	Printer error.	Check printer. After solving the problem, tap Resume to resume printing.*	–
 Printer error: check paper	Specified size of paper is not loaded in printer.	Load the specified paper, tap Resume to resume printing.*	–
 Printer error: paper jam	Paper has jammed in printer.	Eject the jammed paper, tap Resume to resume printing.*	–
 Printer error: out of paper	No paper is loaded in printer.	Load the specified paper, tap Resume to resume printing.*	–
 Printer error: check ink	Ink error.	Check ink, tap Resume to resume printing.*	–
 Printer error: out of ink	Running out of ink or ink cartridge is empty.	Replace ink, tap Resume to resume printing.*	–
 Printer error: file corrupt	An error caused by the image file has occurred.	Tap Cancel to cancel printing.	–

* See the documentation provided with your printer for further guidance and information.

Troubleshooting

If the camera fails to function as expected, check the list of common problems below before consulting your retailer or Nikon-authorized service representative.

Display, Settings and Power Supply





Problem	Cause/Solution	
Monitor is blank.	<ul style="list-style-type: none">• Camera is off.	21
	<ul style="list-style-type: none">• Battery is exhausted.	26
	<ul style="list-style-type: none">• Standby mode for saving power: press the power switch, the shutter-release button,  button, or  button.	21, 149
	<ul style="list-style-type: none">• When flash lamp blinks, wait until flash has charged.	43
	<ul style="list-style-type: none">• Camera and computer are connected via USB cable.	127
	<ul style="list-style-type: none">• Camera and TV are connected via audio/video cable.	124
Monitor is hard to read.	<ul style="list-style-type: none">• When connecting to an electrical outlet using a Charging AC Adapter, the camera cannot be turned on.	18
	<ul style="list-style-type: none">• Adjust monitor brightness.• Monitor is dirty. Clean monitor.	144 159
Camera turns off without warning.	<ul style="list-style-type: none">• Battery is exhausted.	26
	<ul style="list-style-type: none">• Camera has turned off automatically to save power.	149
	<ul style="list-style-type: none">• Battery is cold.	158
	<ul style="list-style-type: none">• The camera turns off if the Charging AC Adapter is connected while the camera is on.	18
	<ul style="list-style-type: none">• The camera turns off if the USB cable connecting it to a computer or printer is disconnected. Reconnect the USB cable.	127, 129, 133
Date and time of recording are not correct.	<ul style="list-style-type: none">• If camera clock has not been set, "Date not set" indicator blinks with shooting and movie recording. Pictures and movies recorded before clock is set are dated "00/00/0000 00:00" or "01/01/2010 00:00" respectively. Set the correct time and date from the Date option in the setup menu.	22, 141
	<ul style="list-style-type: none">• Check camera clock regularly against more accurate timepieces and reset as required.	141
No indicators displayed in monitor.	Tap  to change the information displayed in the monitor.	10, 12
Date imprint not available.	Camera clock has not been set.	22, 141



Problem	Cause/Solution	
Date not appearing on pictures even when Date imprint is enabled.	The current shooting mode is one that does not support Date imprint .	145
Camera settings reset.	Clock battery is exhausted; all settings were restored to their default values.	142
Monitor turns off, and the power-on lamp blinks rapidly.	Battery temperature is high. Turn off camera and allow battery to cool down before resuming use. After the lamp blinks for three minutes, the camera will turn off automatically. Pressing the power switch also turns off the camera.	21
Battery inserted into the camera is not charged when the camera is connected to a computer.	<ul style="list-style-type: none"> • The battery is not charged when the camera is turned off. • Charging stops if the computer enters sleep mode while the battery is charging. The camera may be turned off. • Depending upon computer specifications, settings, and status, it may be impossible to charge the battery inserted into the camera via computer connection. 	131







Electronically Controlled Cameras

In extremely rare instances, unusual characters may appear in the monitor and the camera may stop functioning. In most cases, this phenomenon is caused by a strong external static charge. Turn the camera off, remove and replace the battery, then turn the camera on again. In the event of continued malfunction, contact your retailer or Nikon-authorized service representative. Note that disconnecting the power source as described above may result in the loss of any data not recorded to internal memory or the memory card at the time the problem occurred. Data already recorded will not be affected.

Shooting



Problem	Cause/Solution	
No picture taken when shutter-release button is pressed.	<ul style="list-style-type: none"> • When camera is in playback mode, press the  button or the shutter-release button. • When menus are displayed, tap . • Battery is exhausted. • When flash lamp blinks, flash is charging. 	6, 32 14 26 43
Camera cannot focus.	<ul style="list-style-type: none"> • The intended subject is one with which autofocus does not perform well. • Set AF assist in the setup menu to Auto. • Turn camera off and then on again. 	31 147 21
Pictures are blurred.	<ul style="list-style-type: none"> • Use flash. • Increase the ISO sensitivity value. • Enable electronic vibration reduction or motion detection. • Use BSS (best shot selector). • Use tripod and self-timer. 	42 54 145, 146 53 44
Streaks of light or partial discoloration are visible in the monitor.	Smear occurs when extremely bright light strikes the image sensor. When shooting with Continuous set to Multi-shot 16 and when recording movies, avoiding bright objects, such as the sun, reflections of the sun, and electric lights is recommended.	159
Bright specks appear in pictures taken with flash.	Flash is reflecting off particles in air. Set the flash mode setting to  (off).	43
Flash does not fire.	<ul style="list-style-type: none"> • The flash mode is set to  (off). • Scene mode with which the flash does not function is selected. • On is selected for Blink proof in smart portrait menu. • Movie is selected for shooting mode. • Another function that restricts flash is enabled. 	42 59-67 74 119 58
Optical zoom cannot be used.	Optical zoom cannot be used while recording movies.	120

Problem	Cause/Solution	
Digital zoom cannot be used.	<ul style="list-style-type: none"> • Digital zoom is set to Off in the setup menu. • Digital zoom is not available in the following situations. 	148
	<ul style="list-style-type: none"> - Subject tracking is selected for the touch shooting setting. - When Scene auto selector, Portrait, or Night portrait scene mode is selected. - When shooting in smart portrait mode - When Continuous is set to Multi-shot 16. - Just before recording a movie (up to 2x can be applied while recording movies). 	40 60, 62, 63 72 53 119
Image mode not available.	Another function that restricts the Image mode option is enabled.	58
No sound when shutter is released.	<ul style="list-style-type: none"> • Off is selected for Sound settings>Shutter sound in setup menu. No sound is heard with some shooting modes and settings, even when On is selected. 	148
	<ul style="list-style-type: none"> • The speaker is being blocked. Do not cover the speaker. 	5, 28
AF-assist illuminator does not light.	Off is selected for the AF assist option in the setup menu. AF-assist illuminator may not light depending on the position of the focus area or the current scene mode, even when Auto is selected.	62-68, 147
Pictures appear smeared.	Lens is dirty. Clean lens.	159
Colors are unnatural.	White balance does not match light source.	50
Randomly spaced bright pixels ("noise") appear in image.	Shutter speed too slow or ISO sensitivity is high as the subject is dark. Noise can be reduced by:	
	<ul style="list-style-type: none"> • Using flash. • Specifying a lower ISO sensitivity setting. 	42 54
Pictures are too dark (underexposed).	<ul style="list-style-type: none"> • The flash mode is set to  (off) 	42 28
	<ul style="list-style-type: none"> • Flash window is blocked. • Subject is beyond flash range. • Adjust exposure compensation. • Increase ISO sensitivity. • Subject is backlit. Select Backlight scene mode or set the flash mode setting to  (fill flash). 	42 52 54 42, 67
Pictures are too bright (overexposed).	Adjust exposure compensation.	52

Problem	Cause/Solution	
Unexpected results when flash set to  (auto with red-eye reduction).	When taking pictures with  (auto with red-eye reduction) or fill flash with slow sync and red-eye reduction in Night portrait scene mode, In-Camera Red-Eye Fix may be applied to areas not affected by red-eye. Use any scene mode other than Night portrait , and change the flash mode to any setting other than  (auto with red-eye reduction) and try shooting again.	42, 63
Skin tones are not softened.	<ul style="list-style-type: none"> In some shooting conditions, facial skin tones may not be smoothed. Select  (skin softening) in the retouch menu for pictures containing four or more faces. 	73 112
Saving images takes time.	It may take more time to save images in the following situations. <ul style="list-style-type: none"> When the noise reduction function is in operation When flash mode is set to  (auto with red-eye reduction) When the skin softening function is applied while shooting 	43 43 62, 63, 74

Playback

Problem	Cause/Solution	
File cannot be played back.	<ul style="list-style-type: none"> File or folder was overwritten or renamed by computer or other make of camera. The COOLPIX S4000 is not able to playback movies recorded with another make or model of digital camera. 	– 123
Cannot zoom in on picture.	Playback zoom cannot be used with movies, small pictures, or pictures that have been cropped to a size of 320 × 240 or smaller.	–
Cannot record or play back voice memos.	<ul style="list-style-type: none"> Voice memos cannot be attached to movies. Voice memos cannot be attached to images taken with other cameras. Voice memos attached to images using another camera cannot be played back on this camera. 	123 103

Problem	Cause/Solution	
Cannot edit pictures.	<ul style="list-style-type: none"> • These options cannot be used with movies. • These options cannot be used with pictures taken at an Image mode setting of  3968x2232. • Select pictures that support editing functions. • Camera is unable to edit pictures taken with other cameras. 	<p>123 48</p> <p>105 105</p>
Pictures not displayed on television.	<ul style="list-style-type: none"> • Choose correct Video mode. • Memory card contains no pictures. Replace the memory card. Remove the memory card to play back pictures from the internal memory. • TV display is turned off and pictures are displayed in the camera monitor. 	<p>151 24</p> <p>125</p>
Album icon restored to default settings, or pictures added to album not displayed in favorite pictures playback.	Data on the memory card may not be played back correctly if overwritten by a computer.	–
The recorded pictures are not displayed in auto sort mode.	<ul style="list-style-type: none"> • The desired picture was sorted to a category other than the category currently displayed. • Pictures recorded by a camera other than the COOLPIX S4000 and pictures copied using the Copy option cannot be displayed in auto sort mode. • Pictures recorded in the internal memory or on the memory card may not be played back correctly if overwritten by a computer. • Up to 999 pictures and movies in total can be added to each category. If the desired category already contains 999 pictures or movies in total, new pictures or movies cannot be added. 	<p>88</p> <p>89</p> <p>–</p> <p>89</p>
Nikon Transfer does not start when camera is connected.	<ul style="list-style-type: none"> • Camera is off. • Battery is exhausted. • USB cable is not correctly connected. • Camera is not recognized by the computer. • Confirm system requirements. • Computer is not set to start Nikon Transfer automatically. <p>For more information on Nikon Transfer, refer to help information contained in Nikon Transfer.</p>	<p>21 26 127 – 126 130</p>

Problem	Cause/Solution	
The PictBridge startup screen is not displayed when the camera is connected to a printer.	With some PictBridge-compatible printers, the PictBridge startup screen may not be displayed and it may be impossible to print pictures when Auto is selected for the Charge by computer option in the setup menu. Set the Charge by computer option to Off and reconnect the camera to the printer.	152
Pictures to be printed are not displayed.	<ul style="list-style-type: none"> • Memory card contains no pictures. Replace the memory card. • Remove the memory card to print pictures from the internal memory. • To print pictures created in Draw scene mode over a direct camera-to-printer connection, first create a print order with Print set and then use the DPOF printing option. 	24 24 69, 94, 137
Cannot select paper size with camera.	Paper size cannot be selected from the camera in the following situations, even when printing from a PictBridge-compatible printer: <ul style="list-style-type: none"> • The printer does not support the paper sizes specified by the camera. • The printer automatically selects the paper size. 	134, 135 –

Specifications

Nikon COOLPIX S4000 Digital Camera

Type	Compact digital camera
Effective pixels	12.0 million
Image sensor	$\frac{1}{2}$ -in. CCD; total pixels: approx. 12.39 million
Lens	4x optical zoom, NIKKOR lens
Focal length	4.9-19.6mm (angle of view equivalent to that of 27-108mm lens in 35mm [135] format)
f/-number	f/3.2-5.9
Construction	6 elements in 5 groups
Digital zoom	Up to 4x (angle of view equivalent to that of approx. 432mm lens in 35mm [135] format)
Vibration reduction	Electronic VR
Autofocus (AF)	Contrast-detect AF
Focus range (from lens)	<ul style="list-style-type: none">• Approx. 50 cm (1 ft. 8 in.) to ∞• Macro mode: Approx. 8 cm (3.2 in.) to ∞ (wide-angle position)
Focus-area selection	Face priority, auto (9-area automatic selection), center, manual (focus area can be selected using the touch panel)
Monitor	7.5 cm/3-in., approx. 460k-dot, TFT LCD (touch panel) with anti-reflection coating and 5-level brightness adjustment
Frame coverage (shooting mode)	Approx. 97% horizontal and 97% vertical (Compared to actual picture)
Frame coverage (playback mode)	Approx. 100% horizontal and 100% vertical (Compared to actual picture)
Storage	
Media	<ul style="list-style-type: none">• Internal memory (approx. 45 MB)• SD (Secure Digital) memory cards
File system	DCF, Exif 2.2, and DPOF compliant
File formats	Still pictures: JPEG Sound files (Voice Memo): WAV Movies: AVI (Motion-JPEG compliant)
Image size (pixels)	<ul style="list-style-type: none">• 12M (High) [4000 × 3000★]• 12M [4000 × 3000]• 8M [3264 × 2448]• 5M [2592 × 1944]• 3M [2048 × 1536]• PC [1024 × 768]• VGA [640 × 480]• 16:9 [3968 × 2232]
ISO sensitivity (Standard output sensitivity)	<ul style="list-style-type: none">• ISO 80, 100, 200, 400, 800, 1600, 3200• Auto (auto gain from ISO 80 to 1600)• Fixed range auto (ISO 80 to 400, 80 to 800)

Exposure	
Metering	256-segment matrix, center-weighted (digital zoom less than 2x), spot (digital zoom 2x or more)
Exposure control	Programmed auto exposure with motion detection and exposure compensation (-2.0 to +2.0 EV in steps of 1/3 EV)
Range (📷 auto mode)	[W]: -0.6 to +17.2 EV [T]: 1.2 to 19 EV (exposure values achieved with automatic ISO sensitivity adjustment converted to ISO 100 values)
Shutter	Mechanical and charge-coupled electronic shutter
Speed	1/2000-1 s 4 s (when scene mode is set to Fireworks show)
Aperture	Electronically-controlled ND filter (-2.6 AV) selection
Range	2 steps (f/3.2 and f/8 [W])
Self-timer	Can be selected from 10 and 2 second duration
Built-in flash	
Range (approx.) (ISO sensitivity: Auto)	[W]: 0.5 to 4.5 m (1 ft. 8 in. to 14 ft.) [T]: 0.5 to 2.4 m (1 ft. 8 in. to 7 ft.10 in.)
Flash control	TTL auto flash with monitor preflashes
Interface	Hi-Speed USB
Data Transfer Protocol	MTP, PTP
Video output	Can be selected from NTSC and PAL
I/O terminal	Audio video output/digital I/O (USB)
Supported languages	Arabic, Chinese (Simplified and Traditional), Czech, Danish, Dutch, English, Finnish, French, Greek, German, Hungarian, Indonesian, Italian, Japanese, Korean, Polish, Portuguese, Norwegian, Russian, Spanish, Swedish, Thai, Turkish
Power sources	One EN-EL10 Rechargeable Li-ion Battery (supplied) AC Adapter EH-62D (available separately)
Charging time	Approx. 2 hours and 10 minutes (when using Charging AC Adapter EH-68P/EH-68P (AR) and when no charge remains)
Battery life*	Approx. 190 shots (EN-EL10)
Dimensions (W × H × D)	Approx. 94.5 × 56.5 × 20.4 mm (3.8 × 2.3 × 0.8 in.) (excluding projections)
Weight	Approx. 131 g (4.7 oz.) (including battery and SD memory card)
Operating environment	
Temperature	0 to 40 °C (32 to 104 °F)
Humidity	Less than 85% (no condensation)

Specifications

- Unless otherwise stated, all figures are for a camera with a fully-charged Rechargeable Li-ion Battery EN-EL10 operated at an ambient temperature of 25 °C (77 °F).
- * Based on Camera and Imaging Products Association (CIPA) standards for measuring the life of camera batteries. Measured at 23 (±2) °C (73 (±4) °F); zoom adjusted with each shot, flash fired with every other shot, image mode set to  **4000×3000**. Battery life may vary depending on shooting interval and length of time menus and images are displayed.

Rechargeable Li-ion Battery EN-EL10

Type	Rechargeable lithium-ion battery
Rated capacity	DC 3.7 V, 740 mAh
Operating temperature	0 to 40 °C (32 to 104 °F)
Dimensions (W × H × D)	Approx. 31.5 × 39.5 × 6 mm (1.2 × 1.6 × 0.2 in.) (excluding projections)
Weight	Approx. 15 g (0.5 oz) (excluding battery case)

Charging AC Adapter EH-68P/EH-68P (AR)

Rated input	AC 100-240 V, 50/60 Hz, 0.065-0.04 A
Rated capacity	6.5-9.6 VA
Rated output	DC 5.0 V, 0.5 A
Operating temperature	0 to 40 °C (32 to 104 °F)
Dimensions (W × H × D)	EH-68P: Approx. 55 × 22 × 65 mm (2.2 × 0.9 × 2.6 in.) EH-68P (AR): Approx. 55 × 51.6 × 66 mm (2.2 × 2.0 × 2.6 in.)
Weight	EH-68P: Approx. 60 g (2.1 oz) EH-68P (AR): Approx. 65 g (2.3 oz)

Specifications













Nikon will not be held liable for any errors this manual may contain. The appearance of this product and its specifications are subject to change without notice.

Supported Standards

- **DCF:** Design Rule for Camera File System is a standard widely used in the digital camera industry to ensure compatibility among different makes of camera.
- **DPOF:** Digital Print Order Format is an industry-wide standard that allows pictures to be printed from print orders stored on memory card.
- **Exif version 2.2:** This camera supports Exchangeable Image File Format for Digital Still Cameras (Exif) version 2.2 for digital still cameras, a standard that allows information stored with photographs to be used for optimal color reproduction when images are output from Exif-compliant printers.
- **PictBridge:** A standard developed cooperatively by the digital camera and printer industries, allowing photographs to be output directly to a printer without connecting the camera to a computer.

Index

Symbols

-  Auto mode 26
-  Scene mode 59
-  Smart portrait mode 72
-  Movie 119
-  Playback mode 32
-  Favorite pictures mode 81
-  Auto sort mode 88
-  List by date mode 91
-  Setup menu 138
- T** (Tele) 4
- W** (Wide) 4
-  Playback zoom 4, 79
-  Thumbnail playback 4, 79
-  Shooting mode button 5, 6
-  Playback button 5, 6, 32
- AE/AF-L** 71

A



- AC adapter 160
- AF area 30
- AF area mode 55
- AF assist 147
- Album 83
- Aperture 30
- Audio/video cable 124, 160
- Audio/video-in jack 124
- Auto flash 42
- Auto mode 26
- Auto off 149
- Auto sort menu 90
- Auto sort mode 88
- Autofocus 45
- Autofocus mode 57, 122
- AVI 162

B

- Back light  67
- Battery 16, 18, 142
- Battery charger 18, 160
- Battery latch 5, 16
- Battery level 26









- Battery-chamber 5
- Battery-chamber/memory card slot cover 5, 16, 24
- Beach/snow  64
- Best Shot Selector 53
- Black-and-white 117
- Blink proof 74
- Brightness 144
- BSS 53
- Built-in flash 4, 42
- Built-in microphone 4, 103
- Button sound 148



C

- Charge by computer 152
- Charge lamp 5, 19, 131
- Charger 18
- Charging AC Adapter 18, 160
- Close-up  65
- Cloudy 50
- Color options 117
- Compression ratio 48
- Computer 126, 126–129
 - copying pictures to 126–129
- Connector cover 5
- Continuous 53
- Copy  67
- Copying pictures 100
- Crop 118
- Cyanotype 117

D

- Date 22, 141
- Date imprint 96, 144
- Daylight 50
- Daylight saving time 22, 142
- Delete 33, 98, 104, 123
- Digital zoom 29, 148
- Direct print 132
- D-Lighting 105, 111
- DPOF 177
- DPOF print 137

- Drag 8
- Draw  67, 69
- DSCN 162
- Dusk/dawn  65
- E**
- EH-68P/EH-68P (AR) 18
- Electronic VR 122, 145
- EN-EL10 16, 18
- Exposure comp. 52
- Extension 162
- Eyelet for camera strap 4
- E**
- Face priority 55, 56
- Favorite pictures mode 85
- File names 162
- Fill flash 42
- Fireworks show  67
- Firmware version 156
- Fixed range auto 54
- Flash 42, 43
- Flash lamp 5, 43
- Flash off 42
- Fluorescent 50
- Focus 7, 30, 55
- Folder name 162
- Food  66
- Format 25, 150
- Format memory card 25, 150
- Formatting internal memory 150
- FSCN 162
- Full-frame playback 75
- Full-time AF 57, 122
- H**
- Halfway 7
- Help 15
- I**
- Identifier 162
- Image mode 27, 48, 74
- Image review 144
- Incandescent 50
- Indicator lamp 5
- Internal memory 24
- Internal memory indicator 27
- ISO sensitivity 43, 54
- J**
- JPG 162
- L**
- Landscape  62
- Language 151
- Lens 4, 174
- Lens cover 4
- Li-ion rechargeable battery 16, 18
- List by date menu 92
- List by date mode 91
- M**
- Macro mode 45
- Memory capacity 26
- Memory card 24, 161
- Memory card slot 5, 24
- Menus 140
- Monitor 5, 10, 159
- Monitor settings 144
- Motion detection 146
- Movie length 121
- Movie menu 121
- Movie playback 123
- Movie settings 121
- Multi-shot 16 53
- Museum  66
- N**
- Night landscape  65
- Night portrait  63
- Nikon Transfer 126, 127
- Number of exposures remaining 26, 49
- O**
- Optional accessories 160
- P**
- Paint 107
- Panorama assist  68, 70
- Panorama Maker 126, 130

Paper size 134, 135
Party/indoor  64
Perspective control 115
PictBridge 132, 177
Playback 32, 33, 75, 77, 79, 104, 123
Playback menu 93
Playback mode 80
Portrait  62
Power 22, 26
Power switch 4, 26
Power-on lamp 4, 26
Preset manual 51
Press halfway 7
Print 134, 135
Print set (Date) 95
Printer 132
Protect 100

Q



Quick retouch 110

R

Rechargeable battery 160
Rechargeable Li-ion battery 16
Recording movies 119
Red-eye reduction 42, 43
Reset all 154
Rotate image 102
RSCN 162

S

Scene auto selector  60
Scene mode 59, 62
Self-timer 44
Self-timer lamp 4, 44
Sepia 117
Setup menu 138
Shooting 26, 28, 30
Shooting menu 47
Shooting mode 46
Shutter sound 148
Shutter speed 30
Shutter-release button 4, 30

Single 53
Single AF 57, 122
Skin softening 74, 112
Slide show 97
Slow Sync 42
Small picture 116
Smart portrait menu 74
Smart portrait mode 72
Smile timer 74
Software Suite 126
Sound settings 148
Speaker 5
Sports  63
SSCN 162
Strap 7
Stretch 114
Stylus 9
Subject tracking 40
Sunset  64

T

Tap 8
Thumbnail playback 77
Time zone 22, 141, 143
Touch AF/AE 37
Touch shooting 10
Touch shutter 34
Tripod socket 5
TV 124
TV movie 121

U

USB cable 127, 133
USB/audio/video output connector 5,
124, 126, 132

V

Video mode 125, 151
ViewNX 126
Vivid color 117
Voice memo 103
Volume 104, 123

W

WAV 162

Welcome screen 140

White balance 50

Z

Zoom control 4, 29, 123



A series of horizontal dashed lines spanning the width of the page, intended for handwriting practice.

Nikon

No reproduction in any form of this manual, in whole or in part (except for brief quotation in critical articles or reviews), may be made without written authorization from NIKON CORPORATION.

