

Nikon

DIGITAL CAMERA

COOLPIX S550

User's Manual



En

Trademark Information

- Microsoft, Windows and Windows Vista are either registered trademarks or trademarks of Microsoft Corporation in the United States and/or other countries.
- Macintosh, Mac OS, and QuickTime are trademarks of Apple Inc.
- Adobe and Acrobat are registered trademarks of Adobe Systems Inc.
- The SD logo is a trademark of the SD Card Association.
- PictBridge is a trademark.
- D-Lighting technology is provided by  Apical Limited.
- All other trade names mentioned in this manual or the other documentation provided with your Nikon product are trademarks or registered trademarks of their respective holders.

Introduction

First Steps



Basic Photography and Playback: Auto Mode



High Sensitivity Mode



Shooting Suited for the Scene



Smile Mode



More on Playback



Movies



Voice Recordings

Connecting to Televisions, Computers and Printers

MENU

Shooting, Playback and Setup Menus

Technical Notes

For Your Safety

To prevent damage to your Nikon product or injury to yourself or to others, read the following safety precautions in their entirety before using this equipment. Keep these safety instructions where all those who use the product will read them. The consequences that could result from failure to observe the precautions listed in this section are indicated by the following symbol:



This icon marks warnings, information that should be read before using this Nikon product, to prevent possible injury.

WARNINGS

Turn off in the event of malfunction

Should you notice smoke or an unusual smell coming from the camera or AC adapter, unplug the AC adapter and remove the battery immediately, taking care to avoid burns. Continued operation could result in injury. After removing or disconnecting the power source, take the equipment to a Nikon-authorized service representative for inspection.

Do not disassemble

Touching the internal parts of the camera or AC adapter could result in injury. Repairs should be performed only by qualified technicians. Should the camera or AC adapter break open as the result of a fall or other accident, take the product to a Nikon-authorized service representative for inspection, after unplugging the product and/or removing the battery.

Do not use the camera or AC adapter in the presence of flammable gas

Do not use electronic equipment in the presence of flammable gas, as this could result in explosion or fire.

Handle the camera strap with care

Never place the strap around the neck of an infant or child.

Keep out of reach of children

Particular care should be taken to prevent infants from putting the battery or other small parts into their mouths.

Observe caution when handling the battery

The battery may leak or explode if improperly handled. Observe the following precautions when handling the battery for use in this product:

- Before replacing the battery, turn the product off. If you are using the AC adapter, be sure it is unplugged.
- Only use a Rechargeable Li-ion Battery EN-EL11 (supplied). Charge the battery by inserting it in a Battery Charger MH-64 (supplied).
- When inserting the battery, do not attempt to insert it upside down or backwards.
- Do not short or disassemble the battery or attempt to remove or break the battery insulation or casing.
- Do not expose the battery to flame or to excessive heat.
- Do not immerse in or expose to water.
- Return the battery to the battery case for transportation. Do not transport or store with metal objects such as necklaces or hairpins.
- The battery is prone to leakage when fully discharged. To avoid damage to the product, be sure to remove the battery when no charge remains.
- Discontinue use immediately should you notice any change in the battery, such as discoloration or deformation.
- If liquid from the damaged battery comes in contact with clothing or

skin, rinse immediately with plenty of water.

Observe the following precautions when handling the battery charger

- Keep dry. Failure to observe this precaution could result in fire or electric shock.
- Dust on or near the metal parts of the plug should be removed with a dry cloth. Continued use could result in fire.
- Do not handle the power cable or go near the battery charger during lightning storms. Failure to observe this precaution could result in electric shock.
- Do not damage, modify, forcibly tug or bend the power cable, place it under heavy objects, or expose it to heat or flames. Should the insulation be damaged and the wires become exposed, take it to a Nikon-authorized service representative for inspection. Failure to observe these precautions could result in fire or electric shock.
- Do not handle the plug or battery charger with wet hands. Failure to observe this precaution could result in electric shock.

For Your Safety

Use appropriate cables

When connecting cables to the input and output jacks, use only the cables provided or sold by Nikon for the purpose, to maintain compliance with product regulations.

Handle moving parts with care

Be careful that your fingers or other objects are not pinched by the lens cover or other moving parts.

CD-ROMs

The CD-ROMs supplied with this device should not be played back on audio CD equipment. Playing CD-ROMs on an audio CD player could cause hearing loss or damage the equipment.

Observe caution when using the flash

Using the flash close to your subject's eyes could cause temporary visual impairment. Particular care should be observed if photographing infants, when the flash should be no less than one meter (39 in.) from the subject.

Do not operate the flash with the flash window touching a person or object

Failure to observe this precaution could result in burns or fire.

Avoid contact with liquid crystal

Should the monitor break, care should be taken to avoid injury caused by broken glass and to prevent liquid crystal from the monitor touching the skin or entering the eyes or mouth.

Notices

Notice for Customers in the U.S.A.

Federal Communications Commission (FCC) Radio Frequency Interference Statement

This equipment has been tested and found to comply with the limits for a Class B digital device, pursuant to Part 15 of the FCC rules. These limits are designed to provide reasonable protection against harmful interference in a residential installation. This equipment generates, uses, and can radiate radio frequency energy and, if not installed and used in accordance with the instructions, may cause harmful interference to radio communications. However, there is no guarantee that interference will not occur in a particular installation. If this equipment does cause harmful interference to radio or television reception, which can be determined by turning the equipment off and on, the user is encouraged to try to correct the interference by one or more of the following measures:

- Reorient or relocate the receiving antenna.
- Increase the separation between the equipment and receiver.
- Connect the equipment into an outlet on a circuit different from that to which the receiver is connected.
- Consult the dealer or an experienced radio/television technician for help.



Nikon
COOLPIX S550

CAUTIONS

Modifications

The FCC requires the user to be notified that any changes or modifications made to this device that are not expressly approved by Nikon Corporation may void the user's authority to operate the equipment.

Interface Cables

Use the interface cables sold or provided by Nikon for your equipment. Using other interface cables may exceed the limits of Class B Part 15 of the FCC rules.

Notice for customers in the State of California

WARNING

Handling the cord on this product will expose you to lead, a chemical known to the State of California to cause birth defects or other reproductive harm.

Wash hands after handling.

Nikon Inc.,
1300 Walt Whitman Road
Melville, New York 11747-3064
USA
Tel: 631-547-4200

Notice for customers in Canada

CAUTION

This Class B digital apparatus complies with Canadian ICES-003.

ATTENTION

Cet appareil numérique de la classe B est conforme à la norme NMB-003 du Canada.

Symbol for Separate Collection in European Countries

This symbol indicates that this product is to be collected separately.



The following apply only to users in European countries:

This product is designated for separate collection at an appropriate collection point. Do not dispose of as household waste.

For more information, contact the retailer or the local authorities in charge of waste management.

Table of Contents









For Your Safety	ii
WARNINGS.....	ii
Notices.....	v
Introduction	1
About This Manual	1
Information and Precautions	2
Parts of the Camera	4
The Camera Body	4
The Monitor.....	6
Basic Operations.....	8
The  (Shooting/Playback) Button.....	8
The MODE (Mode) Button	8
The Multi Selector.....	9
The MENU Button.....	10
Help Displays.....	11
Attaching the Camera Strap	11
Shutter-release Button	11
First Steps	12
Charging the Battery	12
Inserting the Battery	14
Removing the Battery	15
Turning On and Off the Camera.....	15
Setting Display Language, Date and Time	16
Inserting Memory Cards	18
Removing Memory Cards.....	19
 Basic Photography and Playback: Auto Mode	20
Step 1 Turn the Camera On and Select  (Auto) Mode	20
Indicators Displayed in  (Auto) Mode	21
Step 2 Frame a Picture	22
Using the Zoom.....	22
Step 3 Focus and Shoot	24
Step 4 Viewing and Deleting Pictures	26
Viewing Pictures (Playback Mode)	26
Deleting Pictures.....	26
Using the Flash.....	28
Setting the Flash Mode	28

Table of Contents

Taking Pictures with the Self-timer	30
Macro Mode	31
Exposure Compensation	32
<hr/>	
 High Sensitivity Mode	33
Shooting in the High Sensitivity Mode	33
<hr/>	
 Shooting Suited for the Scene	34
Shooting in the Scene Mode	34
Setting the Scene Mode	34
Features	35
Taking Pictures for a Panorama	41
<hr/>	
 Smile Mode	43
Shooting in the Smile Mode	43
The Smile Menu	45
Adding to List	45
<hr/>	
 More on Playback	46
Viewing Multiple Pictures: Thumbnail Playback	46
Taking a Closer Look: Playback Zoom	47
Pictures taken in Face Priority	47
Editing Pictures	48
Enhancing Brightness and Contrast: D-Lighting	49
Compensating Blurring After Shooting: Electronic VR	50
Creating a Cropped Copy: Crop	51
 Resizing Pictures: Small Picture	52
Voice Memos: Recording and Playback	53
Recording Voice Memos	53
Playing Voice Memos	54
Deleting Voice Memos	54
Viewing Pictures by Date	55
Selecting a Date in Calendar Mode	55
Selecting a Date in List by Date Mode	56
Using Calendar Mode and List by Date Mode	57
Calendar and List by Date Menus	58
Viewing Smile Pictures	59
Viewing Pictures Shooting in the Smile Mode	59
Smile Menu in Playback Mode	60































 Movies	61
Recording Movies	61
The Movie Menu	62
Selecting Movie Options.....	62
Electronic VR.....	63
Autofocus mode	63
Time-Lapse Movies	64
Movie Playback	66
Deleting Movie Files.....	66
<hr/>	
 Voice Recordings	67
Making Voice Recordings.....	67
Playing Voice Recordings.....	69
Deleting Sound Files.....	70
Copying Voice Recordings.....	71
<hr/>	
Connecting to Televisions, Computers and Printers	72
Connecting to a TV.....	72
Connecting to a Computer.....	73
Before Connecting the Camera.....	73
Transferring Pictures from a Camera to a Computer	74
Connecting to a Printer.....	77
Connecting the Camera and Printer.....	78
Printing Pictures One at a Time.....	79
Printing Multiple Pictures	80
Creating a DPOF Print Order: Print Set.....	83
<hr/>	
MENU Shooting, Playback and Setup Menus	85
Shooting Options: The Shooting Menu	85
Displaying the Shooting Menu and High sensitivity Menu	86
 Image Mode	87
 White Balance	89
 Continuous	91
 ISO Sensitivity.....	93
 Color Options	93
 AF Area Mode	94
 Distortion Control	97
Restrictions on Camera Settings	98

Table of Contents

Playback Options: The Playback Menu	99
Displaying the Playback Menu	99
 Slide Show	101
 Delete	102
 Protect	102
 Rotate Image	103
 Copy	104
Basic Camera Setup: The Setup Menu	105
Displaying the Setup Menu	106
 Menus	106
 Welcome Screen	107
 Date	108
 Monitor Settings	111
 Date Imprint	112
 Electronic VR	114
 AF Assist	115
 Digital Zoom	115
 Sound Settings	116
 Auto Off	116
 Format Memory/  Format Card	117
 Language	118
 Video Mode	118
 Blink Warning	118
 Reset All	120
 Firmware Version	122
Technical Notes	123
Optional Accessories	123
Approved Memory Cards	123
Image/Sound File	124
Image/Sound File and Folder Names	124
Cropped Image Size	125
Caring for the Camera	126
Cleaning	128
Storage	129
Error Messages	130
Troubleshooting	134
Specifications	140
Supported Standards	143
Index	144

About This Manual

Thank you for your purchase of a Nikon COOLPIX S550 digital camera. This manual was written to help you enjoy taking pictures with your Nikon digital camera. Read this manual thoroughly before use, and keep it where all those who use the product will read it.

Symbols and Conventions

To make it easier to find the information you need, the following symbols and conventions are used:



This icon marks cautions, information that should be read before use, to prevent damage to the camera.



This icon marks tips, additional information that may be helpful when using the camera.



This icon marks notes, information that should be read before using the camera.



This icon indicates that more information is available elsewhere in this manual or in the *Quick Start Guide*.

Notations

- A Secure Digital (SD) memory card is referred to as a “memory card.”
- The setting at the time of purchase is referred to as the “default setting.”
- The names of menu items displayed in the camera monitor, and the names of buttons or messages displayed in the computer monitor appear in bold.

Screen Samples

In this manual, images are sometimes omitted from monitor display samples so that monitor indicators can be more clearly shown.

Illustrations and Screen Display

Illustrations and text displays shown in this manual may differ from actual display.

Memory Cards

Pictures taken with this camera can be stored in the camera’s internal memory or on removable memory cards. If a memory card is inserted, all new pictures will be stored on the memory card and delete, playback and format operations will apply only to the pictures on the memory card. The memory card must be removed before the internal memory can be formatted or used to store, delete or view pictures.

Information and Precautions

Life-Long Learning

As part of Nikon's "Life-Long Learning" commitment to ongoing product support and education, continually updated information is available online at the following sites:

- For users in the U.S.A.: <http://www.nikonusa.com/>
- For users in Europe and Africa: <http://www.europe-nikon.com/support/>
- For users in Asia, Oceania, and the Middle East: <http://www.nikon-asia.com/>

Visit these sites to keep up-to-date with the latest product information, tips, answers to frequently asked questions (FAQs), and general advice on digital imaging and photography. Additional information may be available from the Nikon representative in your area. See the URL below for contact information:

<http://nikonimaging.com/>

Use Only Nikon Brand Electronic Accessories

Nikon COOLPIX cameras are designed to the highest standards and include complex electronic circuitry. Only Nikon brand electronic accessories (including battery chargers, batteries and AC adapters) certified by Nikon specifically for use with this Nikon digital camera are engineered and proven to operate within the operational and safety requirements of this electronic circuitry.

THE USE OF NON-NIKON ELECTRONIC ACCESSORIES COULD DAMAGE THE CAMERA AND MAY VOID YOUR NIKON WARRANTY.

For more information about Nikon brand accessories, contact a local authorized Nikon dealer.

Holographic seal: Identifies this device as an authentic Nikon product.



Rechargeable Li-ion
Battery EN-EL11

Before Taking Important Pictures

Before taking pictures on important occasions (such as at weddings or before taking the camera on a trip), take a test shot to ensure that the camera is functioning normally. Nikon will not be held liable for damages or lost profits that may result from product malfunction.

About the Manuals

- No part of the manuals included with this product may be reproduced, transmitted, transcribed, stored in a retrieval system, or translated into any language in any form, by any means, without Nikon's prior written permission.
- Nikon reserves the right to change the specifications of the hardware and software described in these manuals at any time and without prior notice.
- Nikon will not be held liable for any damages resulting from the use of this product.
- While every effort was made to ensure that the information in these manuals is accurate and complete, we would appreciate it were you to bring any errors or omissions to the attention of the Nikon representative in your area (address provided separately).

Notice Concerning Prohibition of Copying or Reproduction

Note that simply being in possession of material that was digitally copied or reproduced by means of a scanner, digital camera or other device may be punishable by law.

- **Items prohibited by law from being copied or reproduced**

Do not copy or reproduce paper money, coins, securities, government bonds or local government bonds, even if such copies or reproductions are stamped "Sample." The copying or reproduction of paper money, coins, or securities which are circulated in a foreign country is prohibited. Unless the prior permission of the government was obtained, the copying or reproduction of unused postage stamps or post cards issued by the government is prohibited. The copying or reproduction of stamps issued by the government and of certified documents stipulated by law is prohibited.

- **Cautions on certain copies and reproductions**

The government has issued cautions on copies or reproductions of securities issued by private companies (shares, bills, checks, gift certificates, etc.), commuter passes or coupon tickets, except when a minimum of necessary copies are to be provided for business use by a company. Also, do not copy or reproduce passports issued by the government, licenses issued by public agencies and private groups, ID cards and tickets, such as passes and meal coupons.

- **Comply with copyright notices**

The copying or reproduction of copyrighted creative works such as books, music, paintings, woodcut prints, maps, drawings, movies and photographs is governed by national and international copyright laws. Do not use this product for the purpose of making illegal copies or to infringe copyright laws.

Disposing of Data Storage Devices

Please note that deleting images or formatting data storage devices such as memory cards or built-in camera memory does not completely erase the original image data. Deleted files can sometimes be recovered from discarded storage devices using commercially available software, potentially resulting in the malicious use of personal image data. Ensuring the privacy of such data is the user's responsibility.

Before discarding a data storage device or transferring ownership to another person, erase all data using commercial deletion software, or format the device and then completely refill it with images containing no private information (for example, pictures of empty sky). Be sure to also replace any pictures selected for the welcome screen (📷 107). Any pictures registered in **Add to list** (📷 45) will be completely removed using **Remove from list**. Care should be taken to avoid injury or damage to property when physically destroying data storage devices.

Parts of the Camera

The Camera Body

Introduction

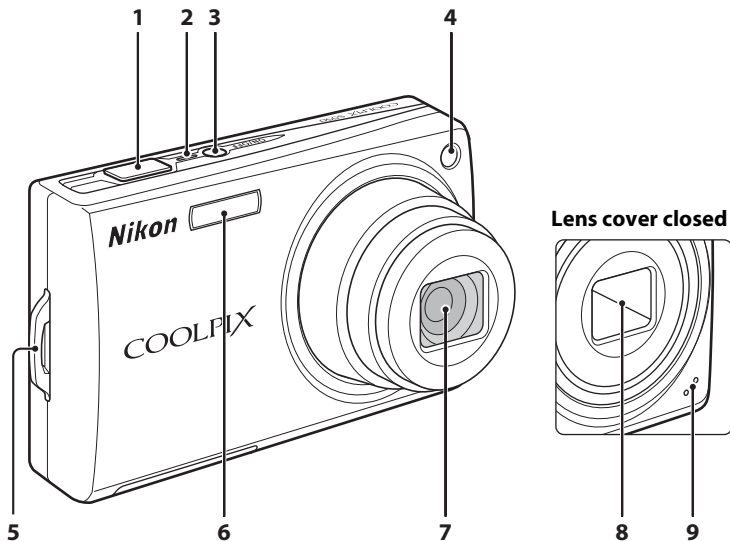

1	Shutter-release button.....	24	6	Built-in flash.....	28
2	Power-on lamp.....	20, 116	7	Lens.....	128, 140
3	Power switch.....	20	8	Lens cover.....	126
4	Self-timer lamp.....	30, 127	9	Built-in microphone.....	53, 61, 67
	AF-assist illuminator.....	25, 115, 127			
5	Eyelet for camera strap.....	11			

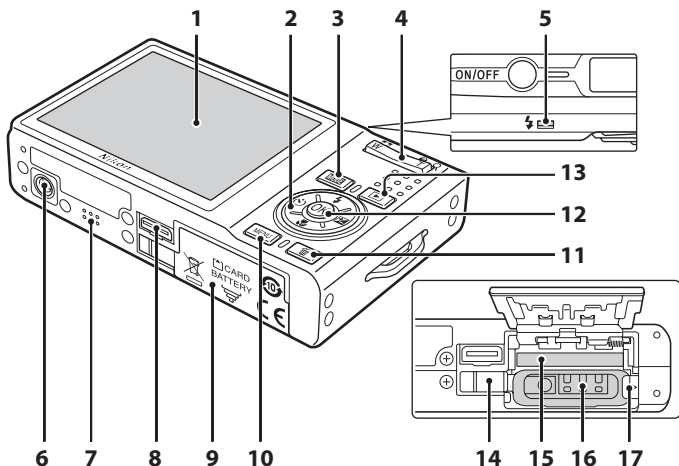

1	Monitor	6	8	Multi connector	72, 74, 78
2	Multi selector	9	9	Battery-chamber/ memory card slot cover	14, 18
3	MODE (mode) button	8	10	MENU button	10, 34, 62, 86, 99
4	Zoom buttons	22	11	(delete) button	26, 27, 54, 66, 70
	W : wide	22	12	OK (apply selection) button	9
	T : tele	22	13	(shooting/playback) button	
	: thumbnail playback	46		8, 26
	: playback zoom	47	14	Power connector cover	123
	: help	11	15	Memory card slot	18
5	Indicator lamp	67	16	Battery-chamber	14
	Flash lamp	29	17	Battery latch	14, 15
6	Tripod socket				
7	Speaker	54, 66, 69			

The Monitor

The following indicators may appear in the monitor during shooting and playback (actual display varies with current camera settings).

The information on indicators in the monitor during shooting and playback will display only for a few seconds (📷 111).

Shooting

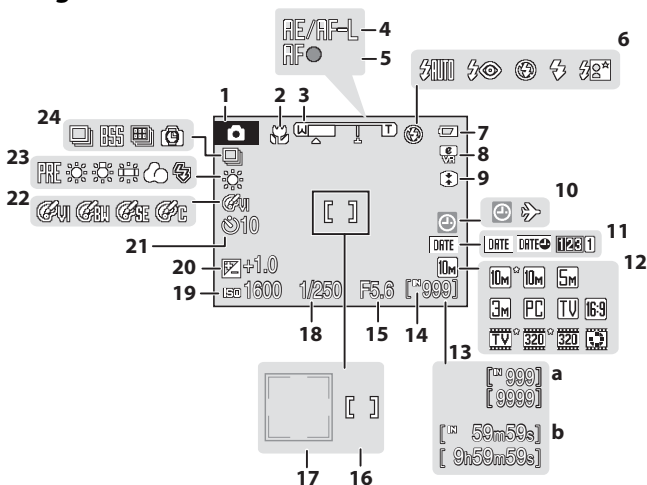

1	Shooting mode*	20, 33, 34, 61	a	Number of exposures remaining (still pictures).....	20
2	Macro mode.....	31	b	Movie length.....	61
3	Zoom indicator.....	22, 31	13	Internal memory indicator.....	21
4	Exposure lock.....	42	14	Aperture	24
5	Focus indicator	24	15	Focus area	24, 94
6	Flash mode.....	28	16	Focus area (Face Priority).....	24, 94
7	Battery level indicator.....	20	17	Shutter speed	24
8	Electronic VR icon	114	18	ISO sensitivity.....	29, 93
9	Distortion control.....	97	19	Exposure compensation value	32
10	"Date not set" indicator	130	20	Self-timer indicator.....	30
11	Time zone indicator.....	108	21	Color options	93
12	Date imprint	112	22	White balance mode.....	89
	Image mode.....	87	23	Continuous shooting mode.....	91
	Movie options	62			

* Differs according to the current shooting mode. Refer to the sections on each mode for details.

Playback

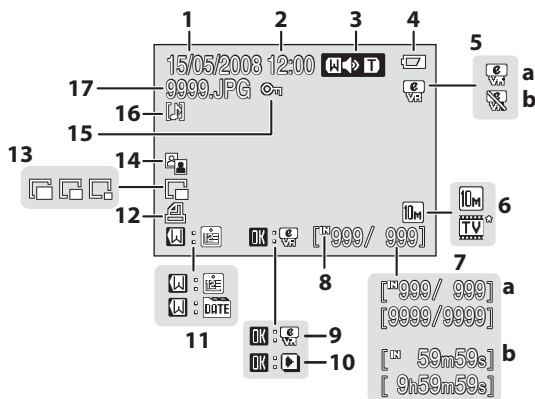





1	Date of recording.....	16	9	Electronic VR guide.....	50
2	Time of recording.....	16	10	Movie playback indicator.....	66
3	Volume indicator.....	53, 66, 69	11	Calendar/List by Date guide.....	55, 56
4	Battery level indicator.....	20	12	Print-order icon.....	83
5	a Compensated image		13	Small picture.....	52
	b Electronic VR not available.....	50, 114	14	D-Lighting icon.....	49
6	Image mode*.....	87	15	Protect icon.....	102
	Movie options*.....	62	16	Voice memo icon.....	53
7	a Current frame number/ total number of frames.....	26	17	File number and type.....	124
	b Movie length.....	66			
8	Internal memory indicator.....	26			

* The displayed icons vary with the settings in shooting mode.

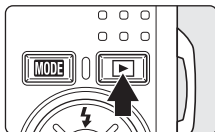
Basic Operations

The (Shooting/Playback) Button



Press  once in shooting mode to enter playback mode; press again to switch back to shooting mode. Pressing the shutter-release button halfway in playback mode ( 26) will also activate shooting mode. If the camera is turned off, hold down  to turn the camera on in playback mode ( 26).

The **MODE** (Mode) Button

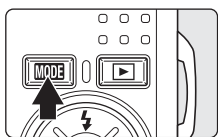

Press **MODE** during shooting to display the shooting-mode selection menu, or during playback to display the playback-mode selection menu. Use the multi selector ( 9) to choose the desired mode.

- Press  to switch between the mode-selection menus for shooting mode and playback mode.

Shooting-mode Selection Menu

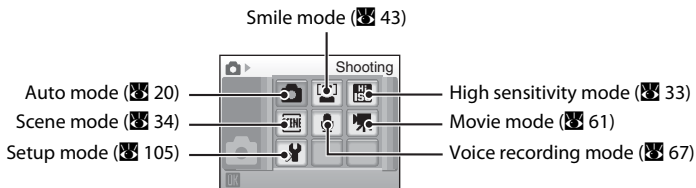

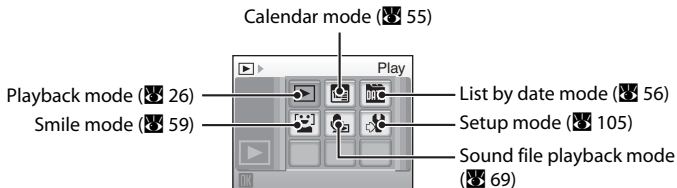

Playback-mode Selection Menu





The Multi Selector



This section describes standard uses of the multi selector to select modes, select menu options and to apply selection.

For Shooting

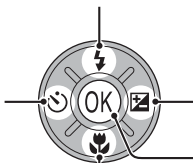

Display  (flash mode) ( 28) menu or move cursor up.

Display  (self-timer) ( 30) menu.



Display  (exposure compensation) ( 32) menu.

Apply selection.

Display  (macro mode) ( 31) menu or move cursor down.

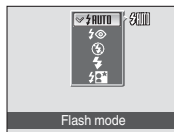

For Playback

Display the previous picture.

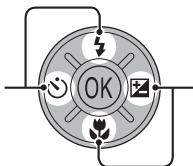

Display the next picture.



For the Menu Screen

Move cursor up.

Move cursor to left or return to the previous screen.

Move cursor down.

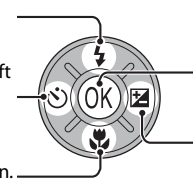



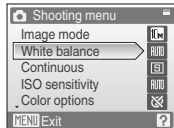

Apply selection (Go to the next screen).

Move cursor to right or go to the next screen (Apply selection).



Notes on the Multi Selector

Multiple operations are available with the multi selector but no detailed operation is described here. In the manual, the button indicating up, down, left and right of the multi selector is shown as , ,  and .

The MENU Button

Press **MENU** to display the menu for the selected mode. Use the multi selector to navigate the menus ( 9).

To exit the menu display, press **MENU** again.

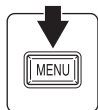

Displayed when there are one or more menu items to follow

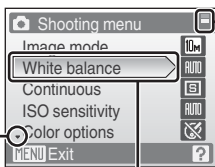



Displayed when the menu contains two or more pages

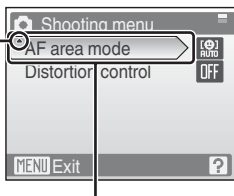

The selected option

Displayed when there are more previous menu items

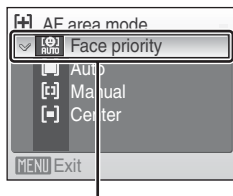

Press the multi selector  or  to proceed to the next set of options.



Press the multi selector  or  to apply selection.

Help Displays

Press **T** (?) when (?) is displayed at the lower right of the menu screen to view a description of the currently selected menu option.

To return to the original menu, press **T** (?) again.

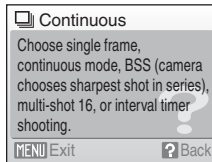
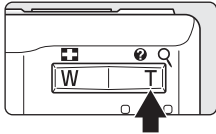

Attaching the Camera Strap

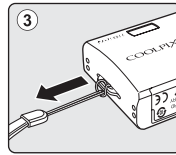
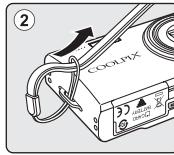
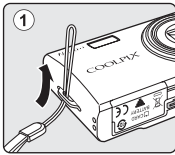

Shutter-release Button

The camera features a two-stage shutter-release button. To set focus and exposure, press the shutter-release button halfway, stopping when you feel resistance. Focus and exposure lock while the shutter-release button is held in this position. To release the shutter and take a picture, press the shutter-release button the rest of the way down. Do not use force when pressing the shutter-release button, as this may result in camera shake and blurred pictures.



Press the shutter-release button halfway to set focus and exposure.

Press the shutter-release button the rest of the way down to take picture.

Charging the Battery

The camera uses a Rechargeable Li-ion Battery EN-EL11 (supplied).

Charge the battery with the Battery Charger MH-64 (supplied) before first use or when the battery is running low.

It is recommended to charge the battery within six months after it was used.

1 Connect the power cable.

Connect the power cable to the battery charger ① and insert the wall plug into a power outlet ②. The CHARGE lamp will light to show that the charger is on ③.

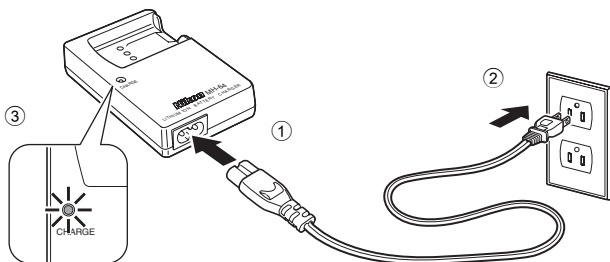

2 Charge the battery.

Insert the battery ① to set it to the battery charger ②.

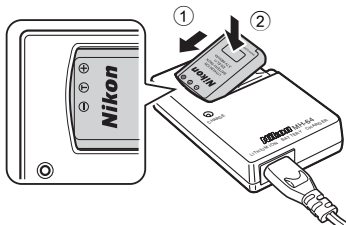

CHARGE lamp starts blinking when battery is inserted ③. Charging is complete when lamp stops blinking ④.

About 120 minutes are required to charge a fully depleted battery.

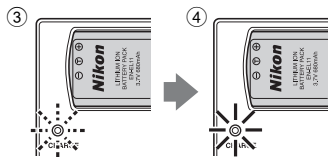

CHARGE lamp	Description
Blinks	Battery charging.
On	Battery fully charged.
Flickers	<ul style="list-style-type: none"> Battery is incorrectly inserted. Remove and reinsert battery at a low angle as shown in Figure 2-①. If ambient temperature is not 5 to 35 °C (41 to 95 °F), wait until temperature is in this range before charging. Battery error. Unplug charger and remove battery immediately and take both devices to retailer or Nikon-authorized service representative.

3 Unplug the charger.

Remove the battery and unplug the charger.

Note on the Battery Charger

Be sure to read and follow the warnings for the battery charger on pages iii and iv before using the battery charger.

The supplied battery charger is for use only with a Rechargeable Li-ion Battery EN-EL11. Do not use with incompatible batteries.

When recharging, the ambient temperature should be in the vicinity of 5 to 35 °C (41 to 95 °F).

The battery will not charge if its temperature is below 0 °C (32 °F) or above 60 °C (140 °F). Charging times may increase at battery temperatures from 0 °C to 10 °C (32 °F to 50 °F) and from 45 °C to 60 °C (113 °F to 140 °F).

Note on the Battery

Be sure to read and follow the warnings for the battery on page iii and the section, “The Battery” (📖 127), before using the battery.

Note on AC power supply

To power the camera continuously for extended periods, use an AC Adapter EH-62E (available separately from Nikon) (📖 123) Do not, under any circumstances, use another make or model of AC adapter. Failure to observe this precaution could result in overheating or in damage to the camera.

Inserting the Battery

Insert a Rechargeable Li-ion Battery EN-EL11 (supplied) that has been fully charged, using the Battery Charger MH-64 (supplied), into your camera.

- 1 Open the battery-chamber/memory card slot cover.

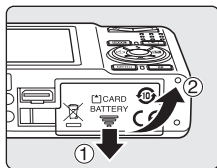

- 2 Insert the battery.

Confirm that the positive (+) and negative (-) terminals are oriented correctly as described on the label at the entrance of the battery chamber, and insert the battery.

The orange battery latch is pushed aside as the battery is inserted.

The battery is fully inserted when the battery latch clicks back into place.

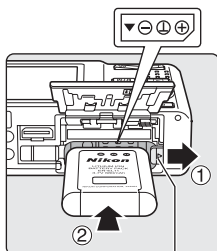

Battery latch

Inserting the Battery

Inserting the battery upside down or backwards will not set the power supply to ON. Be sure to check the battery is in the correct orientation.

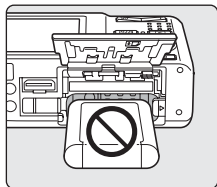

- 3 Close the battery-chamber/memory card slot cover.

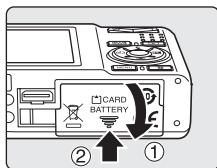

Removing the Battery

Turn the camera off and make sure that the power-on lamp and the monitor have gone out before opening the battery-chamber/memory card slot cover.

To eject the battery, open the battery-chamber/memory card slot cover and slide the battery latch in the direction shown ①. The battery can then be removed by hand ②.

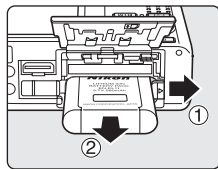

- Note that the battery may become hot during use; observe due caution when removing the battery.

Turning On and Off the Camera

To turn on the camera, press the power switch. The power-on lamp (green) will light for a moment and the monitor will turn on.

To turn off the camera, press the power switch again.

When the camera turns off, both the power-on lamp and monitor will turn off.

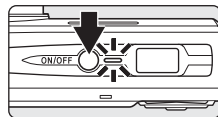

If the camera is turned off, hold down  to turn the camera on in playback mode.

Auto Power-Off in (Auto) Mode (Standby Mode)

The monitor will dim to reduce the drain on the battery if no operations are performed for about five seconds. The monitor will brighten when camera controls are used. At default settings, the monitor will turn off altogether if no operations are performed for about a minute during shooting and playback. The camera will turn off automatically if no operations are performed for another three minutes ( 116).

Setting Display Language, Date and Time

A language-selection dialog is displayed the first time the camera is turned on.

1 Press the power switch to turn on the camera.

The power-on lamp (green) will light for a moment and the monitor will turn on.

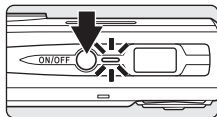

2 Use the multi selector to choose the desired language and press **OK**.

For information on using the multi selector, see “The Multi Selector” (9).



3 Choose **Yes** and press **OK**.

If **No** is selected, the date and time will not be set.

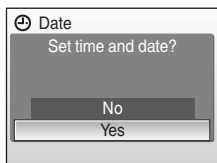

4 Press **OK**.

The home time zone menu is displayed.

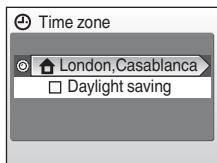

Daylight Saving Time

If daylight saving time is in effect, turn on **Daylight saving** in the **Time zone** menu in Step 4 and set the date.

- 1 Before pressing **OK**, press the multi selector ▼ to choose **Daylight saving**.
- 2 Press **OK** to enable daylight saving time (✓). Pressing **OK** toggles the daylight saving time option on and off.
- 3 Press the multi selector ▲, and then press **OK** to proceed to step 5.

5 Select your home time zone (F110) and press **OK**.

The **Date** menu is displayed.

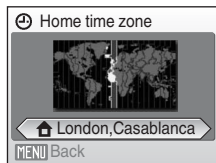

6 Change the date and time.

- Press **▲** or **▼** to edit the highlighted item.
- Press **▶** to move the cursor in the following order.
D -> M -> Y -> Hour -> Minute -> D M Y
- Press **◀** to return to the previous cursor.

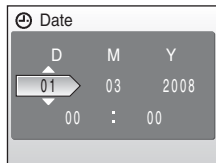

7 Choose the order in which the day, month and year are displayed and press **OK** or press **▶**.

The settings are applied and monitor display returns to shooting mode.

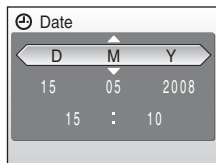

Changing the date and time

- To change the date and time, select **Date** from **Date** (F108) in the setup menu (F105) and follow the instructions starting from the above step 6.
- To change the time zone and the daylight saving settings, select **Time zone** from **Date** in the setup menu (F108, 109).

Inserting Memory Cards

Pictures are stored in the camera's internal memory (approximately 50 MB) or on removable Secure Digital (SD) memory cards (available separately) (123).

If a memory card is inserted in the camera, pictures are automatically stored on the memory card and pictures recorded to the memory card can be played back, deleted or transferred. Remove the memory card to store pictures in the internal memory, or play back, delete or transfer pictures from the internal memory.

1 Turn the camera off and open the battery-chamber/memory card slot cover.

Make sure that the camera is off (the power-on lamp and the monitor are off) before opening the battery-chamber/memory card slot cover.

Make sure that the camera is off (power-on lamp is off) before inserting or removing the memory card.

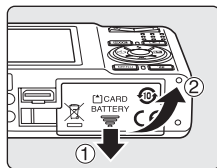

2 Insert the memory card.

Slide the memory card in correctly until it clicks into place.

Close the battery-chamber/memory card slot cover.

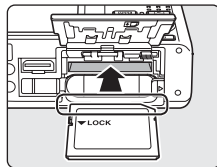

Inserting Memory Cards

Inserting the memory card upside down or backwards could damage the camera or the memory card. Make sure that the memory card is correctly oriented.

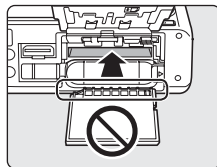

Removing Memory Cards

Before removing memory cards, **turn the camera off** and confirm that the power-on lamp and the monitor are off. Open the battery-chamber/memory card slot cover and press the card in ① to partially eject the card ②. The card can then be removed by hand.

✓ Formatting Memory Cards

If the message at right is displayed, the memory card must be formatted before use (☰ 117). Note that **formatting permanently deletes all pictures and other data on the memory card**. Be sure to make copies of any pictures you wish to keep before formatting the memory card.

Use the multi selector to choose **Yes** and press **OK**. The confirmation dialog will be displayed. To start formatting, choose **Format** and press **OK**.

- **Do not turn the camera off or open the battery-chamber/memory card slot cover until formatting is complete.**
- The first time you insert the memory cards used in other devices into the COOLPIX S550, be sure to format them using this camera (☰ 117).

✓ The Write Protect Switch

SD memory cards are equipped with a write protect switch. Pictures cannot be recorded or deleted and the memory card cannot be formatted when this switch is in the "lock" position. Unlock by sliding the switch to the "write" position.

✓ Memory Cards

- Use only Secure Digital memory cards.
- Do not perform the following during formatting, while data is being written to or deleted from the memory card, or during data transfer to a computer. Failure to observe this precaution could result in the loss of data or in damage to the camera or memory card:
 - Take out the battery or memory card
 - Turn off the camera
 - Disconnect the AC adapter
- Do not format the memory card using a computer.
- Do not disassemble or modify.
- Do not drop, bend, or expose to water or strong physical shocks.
- Do not touch the metal terminals with your fingers or metal objects.
- Do not affix labels or stickers to the memory card.
- Do not leave in direct sunlight, closed vehicles or areas exposed to high temperatures.
- Do not expose to humidity, dust, or to corrosive gases.

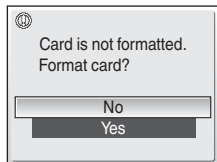
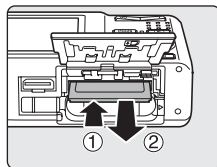

Write protect switch

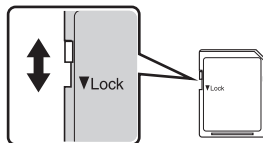

Step 1 Turn the Camera On and Select (Auto) Mode

This section describes how to take pictures in  (auto) mode, an automatic, “point-and-shoot” mode recommended for first-time users of digital cameras.

1 Press the power switch to turn on the camera.

The power-on lamp (green) will light for a moment and the monitor will turn on. In this step, the lens will also open.

Proceed to step 4 when  is displayed.

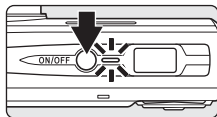

2 Press **MODE**.

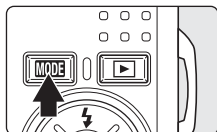



3 Press the multi selector or to choose and press **OK**.

The camera enters  (auto) mode.



4 Check the battery level and number of exposures remaining.

Battery Level

Monitor	Description
NO INDICATOR	Battery fully charged.
	Battery low; prepare to charge or replace the battery.
 Battery exhausted.	Cannot take pictures. Recharge or replace with a fully charged battery.

Battery level indicator

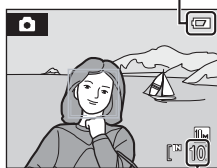

Number of exposures remaining

Number of Exposures Remaining

The number of pictures that can be stored depends on the capacity of the memory or memory card and image mode setting ( 88).

Indicators Displayed in (Auto) Mode

Shooting mode

 displayed in  (auto) mode.

Internal memory indicator

Pictures will be recorded to internal memory (approximately 50 MB). When memory card is inserted,  is not displayed and pictures will be recorded to memory card.

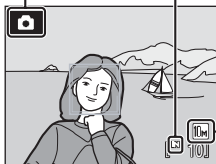

















Image mode





Display image size and quality set in the image mode menu. The default setting is  Normal (3648 × 2736).



The information on indicators in the monitor during shooting and playback will display only for a few seconds ( 111).

Available Functions in (Auto) Mode

In  (auto) mode, macro mode ( 31) and exposure compensation ( 32) can be applied and pictures can be taken using the flash mode ( 28) and self-timer ( 30). Pressing **MENU** in  (auto) mode displays the shooting menu. This menu allows you to specify the image mode ( 87), white balance setting ( 89), and to apply continuous shooting ( 91), ISO sensitivity ( 93), color options ( 93), AF area ( 94) and Distortion control ( 97), to suit shooting conditions or your own preferences.

Electronic VR

When the **Electronic VR** option ( 114) of the Set up menu is set to **Auto** (default setting) and the flash mode ( 28) is set to  (off) or  (slow sync),  may be displayed in the monitor.

When  is displayed, Electronic VR can be applied to effectively reduce blur caused by slight hand movement in shooting, and record the image. Even if the **Electronic VR** can be set to **Off**, a blurred image with  displayed during playback will be compensated after shooting ( 50).

Step 2 Frame a Picture

1 Ready the camera.

Hold the camera steadily in both hands, keeping your fingers and other objects away from the lens, flash and self-timer lamp.

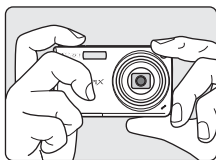

When taking pictures in "tall" orientation, turn the camera so that the built-in flash is above the lens.

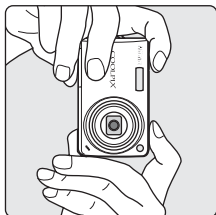

2 Frame the picture.

When the camera recognizes a face (front view), that face will be framed by a yellow double border (by default). If more than one face is recognized, the face nearest to the camera will be framed by a double border and the rest by a single border.

Focus area will not appear when shooting non-human subjects or when no faces are recognized.



Using the Zoom

Use the zoom buttons to activate optical zoom. Press **W** (📐) to zoom out, increasing the area visible in the frame, or **T** (🔍) to zoom in so that the subject fills a larger area of the frame.

Zoom indicator displayed when the zoom buttons are pressed.

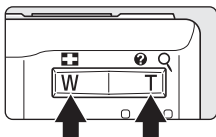

Zoom out Zoom in

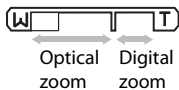

Digital Zoom

When the camera is zoomed in to the maximum magnification (5x), holding down **T** (Q) triggers digital zoom. The subject is magnified up to 4x, for a total magnification of 20x.

The focus area is not displayed when digital zoom is in effect, and focus will be in the center of the screen.

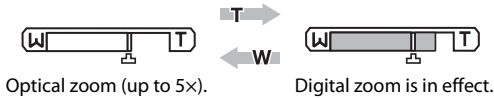

In the digital zoom which is different from the optical zoom, an image is enlarged using the digital processing, creating slightly grainy image.

U is displayed in the zooming position of the maximum ratio without interpolation in the zoom indicator on the monitor.

The zoom indicator will be yellow when the zooming operation goes beyond **U**, and the picture quality in digital zoom begins to degrade.

Maximum zoom ratio without interpolation

The **U** position displayed in the zoom indicator will move to the Zoom in side if the image size in the image mode (87) becomes smaller, and the picture quality won't degrade due to the digital zoom until the magnification reaches the values shown in the table below.

If the magnification at which picture quality in digital zoom begins to degrade, the zooming operation will stop temporarily. In addition, if the **T** (Q) is continuously pressed to increase the magnification, the picture quality in digital zoom begins to degrade.

Image Mode	Zoom rate
04 , 0M	5x (maximum optical zoom)
5M	7x (1.4 digital zoom)

Image Mode	Zoom rate
3M , 16:9	9x (1.8 digital zoom)
PC	18x (3.6 digital zoom)
TV	20x (4 digital zoom)

Digital zoom can be turned off (115)

Step 3 Focus and Shoot

1 Press the shutter-release button halfway.

When people's faces (front view) are recognized:

Camera will focus on the face surrounded by a double border.

Once focus has been locked the double border will glow green.

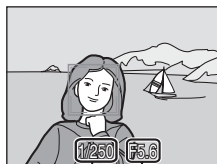
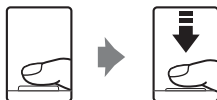

Shutter speed
Aperture

When shooting non-human subjects or when no faces are recognized:

Camera automatically selects the focus area (one of nine) containing the subject closest to the camera.

When the subject is in focus, the active focus area glows green.

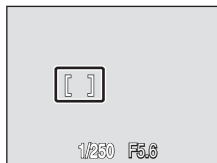

- When the digital zoom is used, the focus indicator (📷 6) glows green once the focus has been locked in the center of the monitor.
- The shutter speed and aperture are displayed when the shutter-release button is pressed halfway.
- The focus and exposure remain locked while the shutter-release button is pressed halfway.
- When the shutter-release button is pressed halfway, and then the double border blinks in Face Priority, or the focus area or the focus indicator blinks red, the camera is unable to focus. Change the composition and press the shutter-release button halfway down again.
- See **AF area mode** (📷 94) or "Face Priority" (📷 96) for more information about Face Priority.

2 Press the shutter-release button the rest of the way down.

The picture will be recorded to the memory card or internal memory.



During Recording

While pictures are being recorded, the  (wait) icon will be displayed and the number of exposures remaining or movie length will blink. Do not turn the camera off, open the battery-chamber/memory card slot cover, or remove or disconnect the power source while these icons are displayed. Cutting power or removing the memory card in these circumstances could result in loss of data or in damage to the camera or card.

Autofocus

Autofocus may not perform as expected in the following situations. In some rare cases, the subject may not be in focus despite the fact that the focus area or the focus indicator glows green:



- Subject is very dark
- Objects of sharply differing brightness are included in the scene (e.g. the sun is behind the subject and is in deep shadow)
- No contrast between the subject and surroundings (e.g. when the subject is standing in front of a white wall, wearing a white shirt)
- Several objects are at different distances from the camera (e.g. the subject is inside a cage)
- Subject is moving rapidly

In the situations noted above, try pressing the shutter-release button halfway to refocus several times, or focus on another subject and use focus lock ( 95). When using focus lock, be sure that the distance between the camera and the subject with which focus was locked is the same as that for the actual subject.

Blink Warning

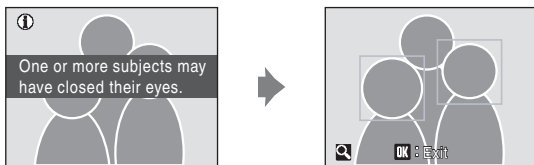
When the screen below is displayed shortly after the picture is taken in Face Priority mode, a picture of human subjects with eyes closed may be shot ( 118).



- Human subjects with eyes closed will be framed by a yellow border in view images mode.
- To return to the shooting mode, press  or press the shutter-release button halfway ( 119).

AF-assist Illuminator and Flash

If the subject is poorly lit, the AF-assist illuminator may light by pressing the shutter-release button halfway, or the flash may fire by pressing the shutter-release button all the way down.

The illuminator has a range of about 1.9 m (6 ft.) at the maximum wide-angle position and 1.1 m (3 ft. 7 in.) at the maximum telescopic position. The AF-assist illuminator can be set to **Off** manually ( 115), although in this case the camera may not focus when lighting is poor.

Step 4 Viewing and Deleting Pictures

Viewing Pictures (Playback Mode)

Press .



The last picture taken will be displayed in full-frame playback mode.

Use the multi selector , ,  or  to view additional pictures.

Pictures may be displayed briefly at low resolution while being read from the memory card or internal memory.

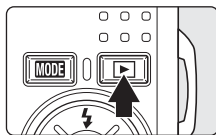
Press  or the shutter-release button to switch to shooting mode.



When  is displayed, pictures stored in the internal memory will be displayed. When memory card is inserted,  is not displayed and pictures stored on the memory card will be displayed.

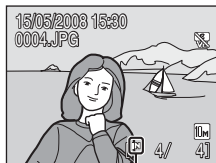



Internal memory indicator

Deleting Pictures

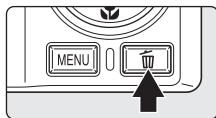
- 1 Press  to delete the picture currently displayed in the monitor.







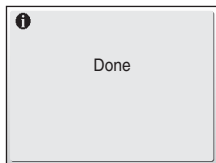
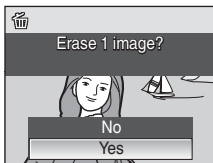



- 2 Use the multi selector to select **Yes** and press .

To exit without deleting the picture, choose **No** and press .





Playback Mode

The following options are available in full-frame playback mode.

Option	Use	Description	
Playback zoom	T (Q)	Press T (Q) to enlarge view of picture currently displayed in monitor up to about 10x. Press OK to return to full-frame playback.	47
View thumbnails	W 	Press W  to display 4, 9, 16 picture thumbnails.	46
Electronic VR	OK	Press OK to compensate a blurred image with  displayed in the monitor.	50
Switch to shooting mode	  	Press  or the shutter-release button to switch to the shooting mode selected in the shooting-mode selection menu.	26

Power on by pressing

If the  is pressed continuously while the power is OFF, the power will be switched ON and playback mode will be started up. However, if the last mode selected before the power was switched OFF was Voice recording mode ( 67) or Voice playback mode ( 69), Voice playback mode will be started up instead.

Viewing Pictures

- Pictures stored in the internal memory can only be viewed if no memory card is inserted.
- Pictures taken in Face Priority, while in full-frame playback, will be rotated (if necessary) and displayed.

Deleting the Last Picture Taken

In shooting mode, press  to delete the last picture taken. When the confirmation dialog shown at right is displayed, use the multi-selector to choose **Yes** and press **OK**.

To exit without deleting the picture, choose **No** and press **OK**.



Using the Flash

The flash has a range of 0.3-4.7 m (1-15.4 ft.) when the camera is zoomed out all the way. With maximum optical zoom applied, the range is 0.6-3.1 m (2-10.2 ft.) (in high sensitivity mode). The following flash modes are available.

AUTO Auto (default setting for (auto) mode)

Flash fires automatically when lighting is poor.

Auto with red-eye reduction

Reduces “red-eye” in portraits ( 29).

Off

Flash will not fire even when lighting is poor.

Fill flash

Flash fires when a picture is taken. Use to “fill-in” (illuminate) shadows and back-lit subjects.

Slow sync

 **AUTO** (auto) is combined with slow shutter speed.

Flash illuminates main subject; slow shutter speeds are used to capture background at night or under dim light.

Setting the Flash Mode



1 Press (flash mode).

The flash menu is displayed.



2 Use the multi selector to choose the desired flash mode and press .

The icon for the selected flash mode is displayed at the top of the monitor.

When  **AUTO** (auto) is applied, regardless of **Photo Info** ( 111),  will go out for a few seconds.

If a setting is not applied by pressing  within a few seconds, the selection will be cancelled.

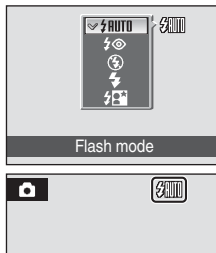

✔ The (Off) Indicator

Note the following when lighting is poor and the flash is **OFF** (⊖):

- Place the camera on a flat, level surface or use a tripod (recommended).
- The **ISO** is displayed when the camera automatically increases sensitivity to minimize blur caused by slow shutter speed. Pictures taken when **ISO** is displayed may be slightly mottled.

✔ Note on Using the Flash

When using the flash at a wide-angle zoom position, reflections from dust particles in the air may appear as bright spots in pictures. To reduce these reflections, set the flash to (Off) or zoom in on the subject.

✍ The Flash Lamp

The flash lamp indicates flash status when the shutter-release button is pressed halfway.

- **On:** Flash will fire when picture is taken.
- **Blinks:** Flash charging. Wait a few seconds and try again.
- **Off:** Flash will not fire when picture is taken.

If remaining battery level is low after using the flash to shoot, the monitor will turn off and the flash lamp will blink until the flash has finished charging.

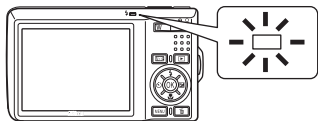

✍ The Flash Mode Setting

The default setting is **SAUTO** (auto) (except for smile mode and some modes in scene mode).

When flash mode is applied in Smile or Scene mode, turning the camera off or switching to another shooting mode changes the flash mode back to the default.

✍ Red-eye Reduction

The COOLPIX S550 is equipped with an advanced red-eye reduction system. Pre-flashes are fired several times at low intensity before the main flash, to reduce "red-eye." If the camera detects "red-eye" after a picture is taken, Nikon's own In-Camera Red Eye Fix processes the image as it is recorded. Therefore, there is a slight delay before the shutter-release button operates normally to take another picture. Note the following when using red-eye reduction:

- Not recommended when shutter-release timing is essential.
- Red-eye reduction may not always produce the desired results.
- In some rare cases, other portions of pictures may be affected.

Use flash modes other than auto with red-eye reduction in above cases.

Taking Pictures with the Self-timer

The camera is equipped with a ten-second and two-second timer for self-portraits. When using the self-timer, use of a tripod is recommended.

1 Press (self-timer).

The self-timer menu is displayed.



2 Use the multi selector to choose **10s** or **2s** and press .

10s (ten seconds): Suited for important occasions (such as weddings)

2s (two seconds): Suited for preventing camera shake

The mode selected for self-timer is displayed.

If a setting is not applied by pressing  within a few seconds, the selection will be cancelled.



3 Frame the picture and press the shutter-release button halfway.

Focus and exposure will be set.

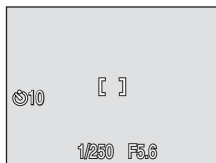

4 Press the shutter-release button the rest of the way down.

The self-timer starts and the self-timer lamp will be displayed in the monitor for a few seconds until the shutter is released. The self-timer lamp is blinking while the self-timer is operating, and the lamp lights up about one second before the shutter is released.

When the shutter is released, the self-timer will be set to **OFF**.

To stop the timer before a picture is taken, press the shutter-release button again.

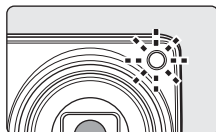
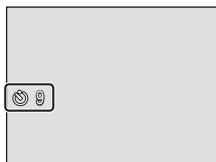

Macro Mode

Macro mode is used for taking pictures of objects as close as 10 cm (3.9 in.). Note that the flash may be unable to light entire subject at distances of less than 30 cm (11.8 in.).

1 Press (macro mode).

The macro menu is displayed.





2 Use the multi selector to choose **ON** and press .

The macro mode icon () is displayed.

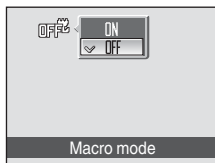
The monitor will return to the normal display for the current mode if the setting is not applied by pressing  within a few seconds.



3 Press **T** () or **W** () to frame the picture.

The camera can focus at distances as close as 10 cm (3.9 in.) when the  and the zoom indicator glows green (zoom indicator is positioned in the left side of .

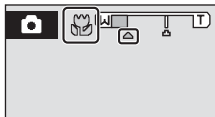

Macro Mode

In macro mode, the camera focuses continuously, even when the shutter-release button is not pressed halfway to lock focus.

The Macro Mode Setting

When macro mode is applied in Scene mode, turning the camera off or switching to another shooting mode changes the macro mode back to the default.

Exposure Compensation

Exposure compensation is used to alter exposure from the value suggested by the camera to make pictures brighter or darker.

1 Press the multi selector (exposure compensation).

The exposure compensation guide is displayed.



2 Use the multi selector to adjust exposure.

- When the picture is too dark: adjust the exposure compensation to "+" side.
- When the picture is too bright: adjust the exposure compensation to "-" side.
- Exposure compensation can be set to values between -2.0 and +2.0 EV.
- If a setting is not applied by pressing **OK** within a few seconds, the selection will be cancelled.

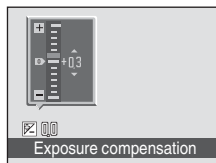

3 The setting is applied.

- The  icon is displayed in the monitor.



Exposure Compensation Value

When exposure compensation is adjusted in Smile or Scene mode, turning the camera off or switching to another shooting mode returns exposure compensation to **0.0**.

Using Exposure Compensation

The camera tends to lower exposure when the frame is dominated by brightly lit objects and to increase exposure when the frame is mostly dark. *Positive* compensation may therefore be required to capture the brilliancy of very bright objects that fill the frame (for example, sunlit expanses of water, sand, or snow) or when the background is much brighter than the main subject. *Negative* compensation may be called for when large areas of the frame contain very dark objects (for example, a swath of dark green leaves) or when the background is much darker than the main subject.

Shooting in the High Sensitivity Mode

In high sensitivity mode, sensitivity is increased when shooting under low lighting, to reduce blurring caused by camera shake or subject movement, allowing you to capture the atmosphere of the scene. ISO sensitivity will be automatically increased to a maximum of 1600, depending upon the brightness of the subject.

- 1 Enter high sensitivity mode by pressing **MODE** in shooting mode, selecting **HI ISO** (use the multi selector), and then pressing **OK**.

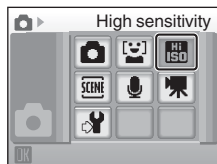
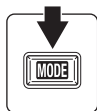

- 2 Frame the subject and shoot.

When people's faces (front view) are recognized the camera will focus on the face surrounded by a double focus area.

When shooting non-human subjects or when no faces are recognized the camera automatically selects the focus area (one of nine) containing the subject closest to the camera.



See **AF area mode** (📷 94) or "Face Priority" (📷 96) for more information about Face Priority.

✓ Notes on High Sensitivity Mode

- This mode reduces effects of camera shake even for shooting under low lighting; however, when shooting without the flash, use of a tripod is recommended.
- Pictures taken in this mode may become somewhat grainy.
- Focus may not be precisely fixed in extremely dark places.

📷 Options that can be used in High Sensitivity

Settings can be changed for Flash mode (📷 28), Self-timer (📷 30), Macro mode (📷 31) and Exposure Compensation (📷 32).

Pressing the **MENU** in high sensitivity mode allows you to change the settings for all options in shooting menu (except **ISO Sensitivity**) (📷 85).

Shooting in the Scene Mode

Camera settings are automatically optimized for the selected subject type. The following scene modes are available.

Portrait	Party/indoor	Night landscape	Copy
Landscape	Beach/snow	Close-up	Back light
Sports	Sunset	Museum	Panorama assist
Night portrait	Dusk/dawn	Fireworks show	

Setting the Scene Mode

- 1 Enter scene mode by pressing **MODE** in shooting mode, selecting **SCENE** (use the multi selector), and then pressing **OK**.

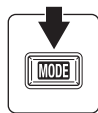

- 2 Press **MENU** to display the scene menu screen, choose the desired scene and press **OK**.

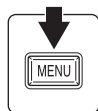

- 3 Frame the subject and shoot.



Image Mode

Image mode (87) can be set in the Scene menu. Changes made to these settings apply to all shooting modes (except for movie menu).

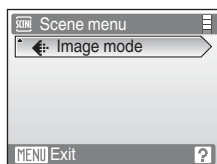

Features

Portrait

Use this mode for portraits in which the main subject stands out clearly. Portrait subjects exhibit smooth, natural-looking skin tones.

- Focus will be set on people's faces if it recognizes people's faces (front view). See "Face Priority" ( 96) for more information.
- If the camera detects a smiling face of the subject, the smile indicator increases or decreases.
- If the camera detects multiple smiling faces, the smiling face positioned at the nearest center of the screen will be detected and come in focus.
- If no faces are recognized, focus will be on the center of the screen.
- Digital zoom is not available.

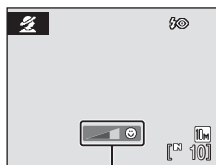

Smile indicator



* Other settings can be selected.

Landscape











Use this mode for vivid landscapes and cityscapes.

- Camera focuses at infinity. The focus area or focus indicator ( 6) always glows green when the shutter-release button is pressed halfway. Note, however, that objects in the foreground may not always be in focus.



* Other settings can be selected.

Icons Used for Descriptions

The following icons are used for descriptions in this section: , flash mode ( 28); , self-timer ( 30); , macro mode ( 31); , exposure compensation ( 32); , AF-assist illumination ( 115).

Scene Mode Settings

Adjustments to the flash mode setting, self-timer setting, macro mode setting, and exposure compensation value are cancelled and these settings return to their default scene values whenever another shooting mode is selected or the camera is turned off.

Shooting in the Scene Mode

Sports

Use this mode for dynamic action shots that freeze the action in a single shot and record motion in a series of pictures.

- While the shutter-release button is pressed halfway, the camera focuses continuously until focus is acquired and locked.
- While shutter-release button is held down, pictures are taken at a rate of about 1.0 frames per second (fps) when image mode is set to **Normal (3648)**. This rate is maintained for up to 8 pictures.
- The maximum frame rate with continuous shooting may vary depending upon the current image mode setting and the memory card used.
- **Electronic VR** (📷 114) is set to **OFF**.



* Other settings can be selected.

Night portrait



Use this mode to achieve a natural balance between the main subject and background lighting in portraits taken at night.

- Focus will be set on people's faces if it recognizes people's faces (front view). See, "Face Priority" (📷 96) for more information.
- If more than one face is recognized, focus will be on the face nearest to the camera.
- If no faces are recognized, focus will be on the center of the screen.
- Digital zoom is not available.



¹ Fill flash with slow sync and red-eye reduction.

² Other settings can be selected.

Party/indoor

Captures the effects of candlelight and other indoor background lighting.

- Camera focuses on subject in center of frame.
- As pictures are easily affected by camera shake, hold the camera steadily. In a dark place, the use of a tripod is recommended.



¹ Slow sync with red-eye reduction. Other settings can be selected.

² Other settings can be selected.

📷: For those scene modes with 📷, use of a tripod is recommended.

NR: For those scene modes with NR, noise reduction is carried out automatically so the time taken to save an image will be longer than usual.

Beach/snow

Captures the brightness of such subjects as snowfields, beaches, or sunlit expanses of water.

- Camera focuses on subject in center of frame.



* Other settings can be selected.

Sunset

Preserves the deep hues seen in sunsets and sunrises.

- Camera focuses at the center of the screen.



* Other settings can be selected.

Dusk/dawn



Preserves the colors seen in the weak natural light before sunrise or after sunset.

- Camera focuses at infinity. When the shutter-release button is pressed halfway, the focus area or focus indicator ( 6) always glows green; however, focus may not be set for near subjects, while the camera focuses at infinity.



* Other settings can be selected.

: For those scene modes with , use of a tripod is recommended.

: For those scene modes with , noise reduction is carried out automatically so the time taken to save an image will be longer than usual.

Shooting in the Scene Mode

Night landscape



Slow shutter speeds are used to produce stunning night landscapes.



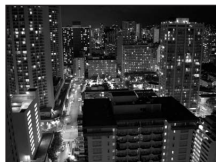

- Camera focuses at infinity. When the shutter-release button is pressed halfway, the focus area or focus indicator () always glows green; however, focus may not be set for near subjects, while the camera focuses at infinity.



* Other settings can be selected.

Close-up

Photograph flowers, insects and other small objects at close range.

- Macro mode () 31) will be changed to **ON** and the zoom will automatically move to the closest possible shooting position.
- The camera can focus at distances as close as 10 cm (3.9 in.) when the  and the zoom indicator glows green. (zoom position is positioned in the left side of ) The closest possible shooting position may vary according to the zoom position.
- **AF area mode** is set to **Manual** () 94). When  is pressed, camera focuses on subject in active focus area.
- While the shutter-release button is pressed halfway, the camera focuses continuously until focus is acquired and locked.
- As pictures are easily affected by camera shake, hold the camera steadily.



* Other settings can be selected. Note that the flash may be unable to light entire subject at distances of less than 30 cm (11.8 in.)

: For those scene modes with , use of a tripod is recommended.

: For those scene modes with , noise reduction is carried out automatically so the time taken to save an image will be longer than usual.

Museum

Use indoors where flash photography is prohibited (for example, in museums and art galleries) or in other settings in which you do not want to use the flash.

- Camera focuses on subject in center of frame.
- BSS (best shot selector) can be used to shoot. (📷 91)
- As pictures are easily affected by camera shake, hold the camera steadily.



* Other settings can be selected.

Fireworks show



Slow shutter speeds are used to capture the expanding burst of light from a firework.

- Camera focuses at infinity. When the shutter-release button is pressed halfway, the focus indicator (📷 6) always glows green; however, focus may not be set for near subjects, while the camera focuses at infinity.
- **Electronic VR** (📷 114) is set to **OFF**.



Copy

Provides clear pictures of text or drawings on a white board or in print.

- Camera focuses on subject in center of frame.
- Use macro mode (📷 31) to focus at short ranges.
- Colored text and drawings may not show up well.

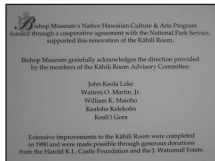

* Other settings can be selected.

📷: For those scene modes with 📷, use of a tripod is recommended.

Shooting in the Scene Mode

Back light

Use when light is coming from behind your subject, throwing features or details into shadow. The flash fires automatically to “fill in” (illuminate) shadows.

- Camera focuses on subject in center of frame.



* Other settings can be selected.

Panorama assist



Use when taking a series of pictures that will later be joined to form a single panorama using the supplied Panorama Maker software.



* Other settings can be selected.

Taking Pictures for a Panorama





The camera focuses on the subject in the center of the frame. Use a tripod for best results.

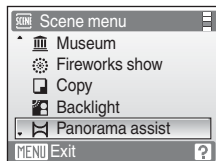





- 1 Use the multi selector to choose  **Panorama assist** in the scene menu and press **OK**.

The panorama direction icon () is displayed to show the direction in which pictures will be joined.



- 2 Use the multi selector to choose the direction and press **OK**.

Select how pictures will be joined together in the completed panorama; right () , left () , up () or down () .

The yellow panorama direction icon () is displayed to the direction pressed and the direction is fixed when **OK** is pressed. The fixed direction  is displayed. Apply flash mode () 28, self-timer () 30, macro mode () 31 and exposure compensation () settings with this step, if necessary. Press **OK** to reselect the direction.



- 3 Shoot the first picture.

The first picture is superimposed in the first third of the monitor.



- 4 Shoot the second picture.

Compose the next picture so that it overlaps the first picture.

Repeat until you have taken the necessary number of pictures to complete the scene.



5 Press **OK** when shooting is completed.

The camera returns to step 2.

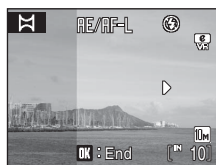
**✔ Panorama Assist**

Flash mode (28), self-timer (30), macro mode (31) and exposure compensation (32) settings cannot be adjusted after the first picture is taken. Pictures cannot be deleted, nor can zoom or image-mode setting (87) be adjusted until the series is finalized.

The panorama series is terminated if the camera enters standby mode with the auto off function (116) during shooting. Setting the time allowed to elapse before the auto off function is enabled to a longer setting is recommended.

🔒 Exposure Lock

AE/AF-L is displayed to indicate that white balance, exposure, and focus have been locked at the values set with the first shot. All pictures taken in a panorama series have the same white balance, exposure, and focus settings.

🔒 Panorama Maker

Install Panorama Maker from the supplied Software Suite CD. Transfer pictures to a computer (73) and use Panorama Maker (76) to join them in a single panorama.

**🔒 More Information**

See, "Image/Sound File and Folder Names" (124) for more information.

Shooting in the Smile Mode

The camera detects a smiling face to shoot the face automatically.

- 1 Enter smile mode by pressing **MODE** in shooting mode, selecting  (use the multi selector), and then pressing **OK**.

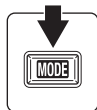

- 2 Frame a picture.

- Point the camera at the subject.
- If the camera recognizes the people's face (front face), the face will be framed by a double yellow border in the focus area, and when the face comes into focus, the double border will instantly be green and the focus will be locked.
- When the faces of the multiple peoples are recognized, the people positioned at the nearest center of the screen will be framed by a double border in the focus area and the other faces will be framed by a single border. Up to three faces will be recognized.
- If the face of the people registered in **Add to list** () 45) is recognized, the border color will be blue.

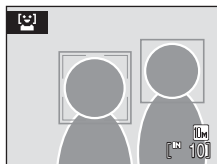

- 3 The shutter is automatically released.

- If the camera detects the smiling face of the people framed by a double border, the shutter is automatically released.
- When the face registered in the **Add to list** is recognized and the blue border frame is displayed, the shutter is automatically released by detecting the smiling face of the people framed by the blue border. If 2 or more blue border frames are observed, the shutter is released by detecting the people's face positioned at the nearest center of the screen.
- Each time the shutter is released, the camera automatically shoot pictures using the recognizing face and the detecting smiling face features repeatedly.

- 4 Exit smile mode by pressing **MODE**.

- Change to the other shooting mode.
- The auto power off will be effective and monitor will turn off if the shutter is not released and no operations are performed for about five minutes. The camera will turn off automatically if no operations are performed for another three minutes. ( 116)
- The shooting is terminated if the internal memory or removal Secure Digital (SD) memory card has no capacity.

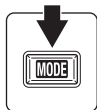

Face Priority and Smiling Face Detection features

When the camera is pointed at a people's face (front face) in the smile mode, the face is automatically recognized and the smiling face of the recognized one is detected.

- In some shooting conditions, face priority will not take effect and smiling face cannot be detected.
- See "Face Priority" (📖 96) for more information about Face Priority.

Operation of Shutter-Release Button

Press the shutter-release button to shoot pictures.

- When the Face priority takes effect, the focus is locked to the recognized face and the shutter-release button is automatically released.
- When the Face priority doesn't take effect, the camera focuses on a subject in the same way as the **AF area mode** is set to **Auto** (📖 94). The camera focuses on one of the 9 focus areas which captures the nearest subject.
- When the shutter-release button is pressed halfway and released in Face priority mode, the camera will recognize the face again. Pressing  will also recognize the face again.

Recognition of Add to List

- When two people are framed with a single border and only one of them is registered in **Add to list**, the single border color does not become blue. Also in this case, if the double border is yellow and the smiling face recognized as a registered people is detected, the shutter is released.
- When people are registered in **Add to list** and **Face recognition** is set to **ON** (📖 45), the registered people may not be recognized and the AF area display frame may not be blue.

Available Functions in Smile Mode

- The default setting of the flash mode in smile mode is  (Auto with red-eye reduction).
- Settings can be changed for Flash mode (📖 28) and Exposure Compensation (📖 32).
- Digital zoom is not available.

Playing Back Pictures where Smiling Faces Are Detected

When  is selected from the playback mode menus, the pictures shot by detecting smiling faces in the smile mode can be played back. See "Viewing Smile Pictures" (📖 59) for more information on using this function.

The Smile Menu

The following item can be set in the smile menu.

For displaying the smile menu, press **MENU** in the smile mode.



Image mode

Choose an image size and quality (87).

Changes made to the settings in the image mode apply to all shooting modes.



Face recognition

When **ON** (default setting) is selected, the camera gives priority to the smiling face of the people registered in **Add to list** to detect and the shutter is released. The registered peoples' faces framed by a blue border when the camera recognizes faces.



Add to list

The people you want to give priority for detecting in smile mode will be registered.



Remove from list

Any image registered in **Add to list** will be selected in the selecting multiple pictures (100) and removed. You can also check the registered pictures.

Adding to List

The people you want to give priority for detecting smiling face will be registered. If you set the **Face recognition** to **ON** and shoot the picture, the camera detects the smiling face of the registered people and the shutter is automatically released.

1 Use the multi selector to choose **Add to list** in the smile menu and press **OK**.

- The camera enters the display for registration.

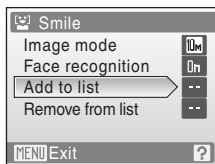

2 Take a picture of the human face you want to register so that the face's eyes and mouth are positioned in the frame displayed on the monitor.

- Flash will not fire.
- When the shot pictures are registered, **Added to list** will appear.
If you failed to register the pictures, **Could not add to list** will appear. Refit to the guide and shoot again.
- It is unnecessary to shoot the smiling face in registering the face.
- To exit the display for registration, press **OK**.



Viewing Multiple Pictures: Thumbnail Playback

Press **W** (📷) in full-frame playback mode (📷 26) to display pictures in “contact sheets” of thumbnail images. The following operations can be performed while thumbnails are displayed.



To	Use	Description	📷
Choose pictures		Press the multi selector ▲, ▼, ◀ or ▶.	9
Change number of pictures displayed	W (📷) T (📷)	When W (📷) is pressed, display picture thumbnails in the following order: 4 → 9 → 16 When T (📷) is pressed, the number of thumbnails changes reversely.	–
Cancel thumbnail playback		Press OK .	26
Switch to shooting mode	 	Press or the shutter-release button to return to the last shooting mode selected.	26

Thumbnail Playback Mode Display

While pictures selected for printing (📷 83) and protected pictures (📷 102) are chosen, the icons shown at right are displayed with them. Movies are displayed as film frames.

Print-order icon Protect icon

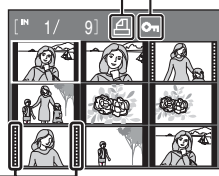

Film frames

Smile mode icon

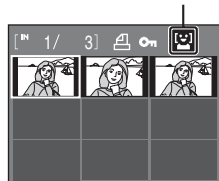

Thumbnail Smile Mode Display

While the pictures are played back in the smile mode (📷 43, 59), the icon shown at right are displayed.

Taking a Closer Look: Playback Zoom

Pressing **T** (Q) during full-frame playback mode (26) zooms the current picture in 3x, with the center of the picture displayed in the monitor.

- The guide displayed in the right bottom in the monitor will show which part of the image is currently displayed.



The following operations can be performed while pictures are zoomed in.

To	Use	Description	26
Zoom in	T (Q)	Press T (Q) to enlarge view of picture currently displayed in monitor, up to about 10x.	-
Zoom out	W (Z)	Press W (Z). When the magnification ratio reaches 1x, the display returns to full-frame playback mode.	-
View other areas of picture		Press the multi selector ▲ , ▼ , ◀ or ▶ to scroll to areas of the picture not visible in the monitor.	9
Switch to full-frame playback	OK	Press OK .	26
Crop picture	MENU	Press MENU to crop current picture to contain only the portion visible in the monitor.	51
Switch to shooting mode		Press or the shutter-release button to return to the last shooting mode selected.	26

Pictures taken in Face Priority

When pressing **T** (Q) during full-frame playback mode, the picture taken in Face Priority (96) will be enlarged using the face (which was focused on during shooting time) as the centralized point.

- If several faces are recognized, the picture will be enlarged using the face (which was focused on during shooting time) as the centralized point, and pressing the multi selector **▲**, **▼**, **◀** or **▶** will enable you to switch between the people's faces.
- Further pressing **T** (Q) or **W** (Z) can change the magnification ratio and the pictures will be zoomed in as usual.

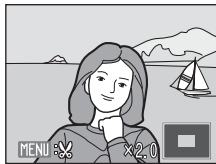

Editing Pictures

Use the COOLPIX S550 to edit pictures in-camera and store them as separate files (📷 124). The editing features described below are available.

Editing function	Description
D-Lighting (📷 49)	Create a copy of the current picture with enhanced brightness and contrast, brightening dark portions of the picture.
Electronic VR (📷 50)	Compensate blurring, caused by slight hand movement during shooting, after pictures are shot.
Crop (📷 51)	Enlarge the image or refine the composition and create a copy containing only the portion visible in the monitor.
Small picture (📷 52)	Create a small copy of pictures suitable for use on web pages or as e-mail attachments.

Picture Editing

- Pictures taken at an **Image mode** setting of **16:9 (1920)** (📷 87) cannot be edited except Electronic VR.
- The COOLPIX S550 editing functions are not available for pictures taken with non-COOLPIX S550 digital cameras.
- If a copy created using the COOLPIX S550 is viewed on a different digital camera, the picture may not be displayed or may not be transferred to a computer.
- Editing functions are not available when there is not enough free space in the internal memory or on the memory card.

Restrictions on Picture Editing

(✓: available, -: not available)

1st editing	2nd editing			
	D-Lighting	Electronic VR	Crop	Small picture
D-Lighting	-	✓	✓	✓
Electronic VR	✓	-	✓	✓
Crop	-	-	-	-
Small picture	-	-	-	-

- Pictures cannot be edited twice with the same editing function.
- The D-Lighting or Electronic VR should be done first while the restricted use of combination exists.

Original Pictures and Edited

- Copies created with editing functions are not deleted if the original pictures are deleted. The original pictures are not deleted if copies created with editing functions are deleted.
- Edited copies are stored with the same recording date and time as the original.
- Edited copies have the same transfer marking as the original but are not marked for printing (📷 83) or protecting (📷 102).

Enhancing Brightness and Contrast: D-Lighting

D-Lighting can be used to create copies with enhanced brightness and contrast, brightening dark portions of a picture. Enhanced copies are stored as separate files.

- 1 Select the desired picture from full-frame (📄 26) or thumbnail (📄 46) playback mode and press **MENU**.

The playback menu will be shown.

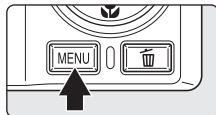

- 2 Use the multi selector to choose **D-Lighting** and press **OK**.

The original version will be shown on the left and the edited version will be shown on the right.



- 3 Choose **OK** and press **OK**.

A new copy with enhanced brightness and contrast is created.

To cancel D-Lighting, choose **Cancel** and press **OK**.



D-Lighting copies can be recognized by the 📄 icon displayed during playback.





More Information

See, "Image/Sound File and Folder Names" (📄 124) for more information.

Compensating Blurring After Shooting: Electronic VR

Blurring in pictures shot without electronic VR enabled, and marked with  (electronic VR guide) in full-frame playback mode, can be compensated with electronic VR after shooting. When electronic VR is applied to pictures after they are shot, compensated copies are stored as separate files.

- 1 Choose the desired picture in full-frame playback ( 26) and press .

Blurring compensation can only be applied to pictures marked with .



- 2 Use the multi selector to choose **OK** and press .

Compensated image is created.



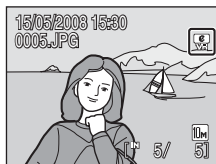
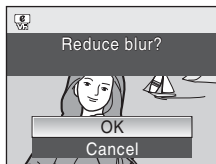

To cancel vibration reduction, choose **Cancel** and press .

For compensated images, the  indicator is displayed in the monitor during playback.



Notes on Electronic VR

In addition to the restrictions described in "Restrictions on Picture Editing" ( 48), electronic VR cannot be used for the following pictures:

- Pictures marked with  that were compensated
- Pictures marked with  that were not compensated
 - Pictures shot with Multi-shot 16 ( 91) or with slow shutter speeds
 - Pictures with date imprint ( 84)
 - Pictures with minor blur, or pictures that are badly blurred.

More Information

See "Electronic VR" ( 114) and "Image/Sound File and Folder Names" ( 124) for more information.

Creating a Cropped Copy: Crop



This function is only available when **MENU**  is displayed in the monitor with playback zoom  47) enabled. Cropped copies are stored as separate files.

1 Press **T** () in full-frame playback mode to zoom in on the image.

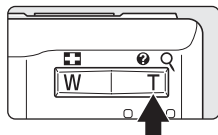
- The image displayed in full-frame playback mode and in “tall” orientation can be cropped if the image is enlarged to fill the horizontal screen or larger. To crop the image in “tall” orientation, use **Rotate image** ( 103) to display the image vertically before the image is enlarged.



2 Refine copy composition.

Press **T** () or **W** () to adjust the zoom ratio.

Press the multi selector , ,  or  to scroll the picture until only the portion you want to copy is visible in the monitor.

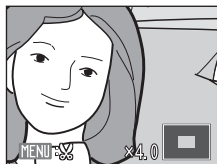

3 Press **MENU**.

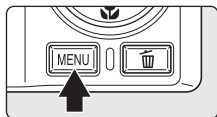



4 Use the multi selector to choose **Yes** and press **OK**.

A new picture, containing only the portion visible in the monitor, is created.



The size of the cropped copies varies depending on the zoom ratio in effect at the time the copy was created ( 125).



When the image-mode setting for cropped copies is 320 × 240 or 160 × 120, these pictures are framed with a gray border in playback mode, and Small Picture icon  or  is displayed in the left side of the monitor.



More Information

See, “Image/Sound File and Folder Names” ( 124) for more information.

Resizing Pictures: Small Picture

Create a small copy of the current picture. Small copies are stored as JPEG files with a compression ratio of 1:16. The following sizes are available.

Option	Description
 640×480	Suited to television playback.
 320×240	Suited to display on web pages.
 160×120	Suitable for e-mail attachments.

- 1 Select the desired picture from full-frame () 26) or thumbnail () 46) playback mode and press **MENU**.

The playback menu is displayed.

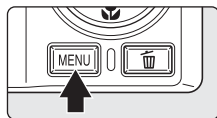

- 2 Use the multi selector to choose **Small pic.** and press **OK**.

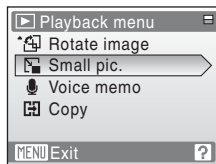

- 3 Choose the desired copy size and press **OK**.

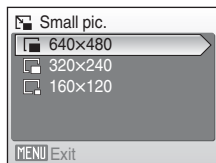

- 4 Choose **Yes** and press **OK**.

A new, smaller copy is created.

The copy is displayed with a gray frame.



More Information

See, "Image/Sound File and Folder Names" () 124) for more information.

Voice Memos: Recording and Playback

Use the camera's built-in microphone to record voice memos for pictures.

Recording Voice Memos

- 1 Select the desired picture from full-frame playback mode (📷 26) and press **MENU**.

The playback menu is displayed.

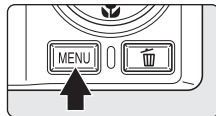

- 2 Use the multi selector to choose **Voice memo** and press **OK**.

The screen for recording a voice memo will be displayed.

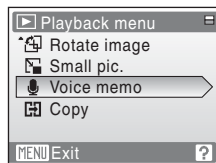

- 3 Press and hold **OK** to record a voice memo.

Recording ends after 20 seconds or when **OK** is released.

Do not touch the built-in microphone during recording.

During recording, **REC** and **[M]** blink in the monitor.

When recording ends, the voice memo playback screen is displayed. Follow the instructions in step 3 of "Playing Voice Memos" (📷 54) to play the voice memo.

Press **MENU** before or after recording a voice memo to return to full-frame playback mode.



More Information

See "Image/Sound File and Folder Names" (📷 124) for more information.

Playing Voice Memos

Pictures for which voice memos have been recorded are indicated with  in fullframe playback mode.

- 1 Select the desired picture from full-frame playback mode ( 26) and press **MENU**.

The playback menu is displayed.

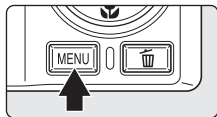
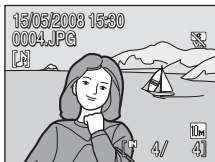

- 2 Use the multi selector to choose **Voice memo** and press **OK**.

The screen for playing a voice memo will be displayed.

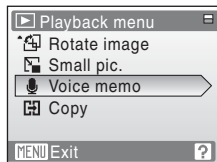

- 3 Press **OK** to listen to the voice memo.



Playback ends when the voice memo ends or **OK** is pressed again.

Press the zoom buttons to adjust the volume.

Press **MENU** before or after playing a voice memo to return to full-frame playback mode.



Deleting Voice Memos

Select a picture with a voice memo and press . Use the multi selector to choose  and press **OK**. Only the voice memo will be deleted.



Voice Memos

- When a picture with a voice memo attached is deleted, both the picture and its voice memo are deleted.
- If a voice memo already exists for the current picture, it must be deleted before a new voice memo can be recorded.
- The COOLPIX S550 cannot be used to attach voice memos to pictures shot with cameras other than the COOLPIX S550.

Viewing Pictures by Date

In calendar mode or list by date mode, pictures taken on a specified date can be displayed. In full-frame playback mode, just as with playback mode, picture display can be enlarged, pictures can be edited, voice memos can be recorded or played back, and movies can be played back. When **MENU** is pressed, the calendar menu or the list by date menu is displayed, and all pictures taken on a specified date can be selected for deletion, printing, protection and transfer.

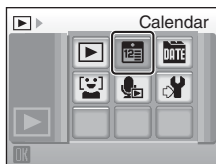
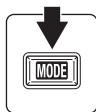

Selecting a Date in Calendar Mode

- 1 Enter calendar mode by pressing **MODE** in playback mode, selecting  (use the multi selector), and then pressing **OK**.



- 2 Choose the desired date and press **OK**.

Dates for which pictures exist are underlined in yellow.

Press **W**  to view the previous month, or press **T**  to view the following month.

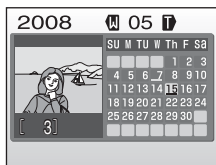

The first picture for that date will be displayed full-frame.

Press **W**  in full-frame playback mode to return to calendar mode.

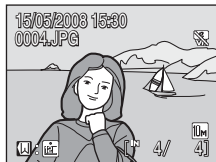

Selecting a Date in List by Date Mode

- 1 Enter list by date mode by pressing **MODE** in playback mode, selecting **DATE** (use the multi selector), and then pressing **OK**.

Dates for which pictures exist will be listed.

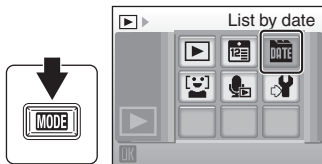

- 2 Choose the desired date and press **OK**.

Camera lists up to 29 dates. If pictures exist for more than 29 dates, all pictures recorded earlier than most recent 29 dates will be listed together as **Others**.

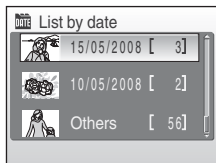



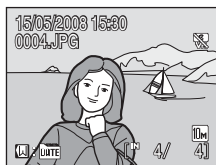











The first picture for that date will be displayed full-frame. Press **W** () in full-frame playback mode to return to the date list.



Using Calendar Mode and List by Date Mode

The following operations are possible from the date selection screen.









To	Use	Description	
Select date		Use the multi selector to select a date.	9
Select month (calendar mode only)	W  T 	Press W  to view the previous month, or press T  to view the following month.	–
Switch to full-frame playback		Press  to display the first picture taken on the selected date. Press W  in full-frame playback to return to the calendar or list by date mode selected before viewing in full-frame playback.	26
Delete picture		Press  to delete all pictures taken on the selected date. Choose Yes on the confirmation dialog to be displayed.	26
View calendar or list by date menu	MENU	Press MENU to display the calendar or list by date menu.	58
View playback-mode menu	MODE	Press MODE to display the playback-mode selection menu.	8
Switch to shooting mode	  	Press  or the shutter-release button to return to the last shooting mode selected.	26

Notes on Calendar Mode and List by Date Mode

- Up to 9,000 pictures can be displayed in calendar mode or in list by date mode. If more pictures exist, “**” is displayed next to the number.
- Pictures taken with no date stamp are not listed in these modes.

Calendar and List by Date Menus

Press **MENU** in either mode to display the following menus for only the pictures taken on the specified date.

D-Lighting*	 49
Print set	 83
Slide show	 101
Delete	 102
Protect	 102
Rotate image*	 103
Small pic.*	 52
Voice memo*	 53

* During full-frame playback only

When **MENU** is pressed in the date selection screen ( 55, 56), options can be applied to all pictures taken on the same date, or all pictures taken on the same date can be deleted. To apply options to individual pictures, or to select individual pictures for deletion, display a picture full-frame and press **MENU**.

Print Set

When print marking already exists for pictures taken on dates other than that specified, a confirmation dialog **Save print marking for other dates?** will be displayed. Select **Yes** to add the new print to the existing marking. Select **No** to remove the existing print and leave only the new marking.

Viewing Smile Pictures

Only the pictures shot in the smile mode ( 43) will be played back.

Viewing Pictures Shooting in the Smile Mode

1 Enter smile mode by pressing **MODE** in playback mode, selecting  (use the multi-selector), and then pressing **OK**.

- The pictures shot by detecting the smiling faces in the smile mode are displayed.
- The icon shown at right will be displayed while the pictures are played back in the smile mode.

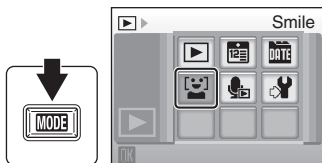



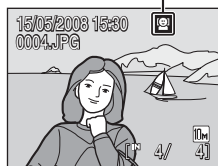







Smile mode icon during playing back







Smile Mode during Playing back

The following options are available in the Smile Mode during playing back.

Option	Use	Description	
Playback zoom	T ()	Press T () to enlarge view of picture currently displayed in monitor, up to about 10x. Press OK to return to full-frame playback.	47
		Press MENU to crop the picture which is being enlarged.	51
View thumbnails	W ()	Press W () to display 4, 9, 16 picture thumbnails.	46
Delete picture		Delete all or selected pictures.	26
View Smile menu in playback mode	MENU	Press MENU to display the Smile menu in playback mode.	60
View playbackmode menu	MODE	Press MODE to display the playback-mode selection menu.	8
Switch to shooting mode	  	Press  or the shutter-release button to return to the last shooting mode selected.	26

Smile Menu in Playback Mode

Press **MENU** while the pictures are played back in the smile mode to display the following menu.

D-Lighting	 49
Print set	 83
Slide show	 101
Rotate image	 103

Notes on Smile Mode during Playing back

Up to 999 pictures from that shot in the oldest day can be displayed in smile playback mode.

Recording Movies

To shoot movies with sound recorded via the built-in microphone, select shooting mode and follow the steps below.

- 1 Enter movie mode by pressing **MODE** in shooting mode, selecting  (use the multi selector), and then pressing **OK**.

The maximum length of the movie that can be recorded and the movie options ( 62) icon are displayed in the monitor.

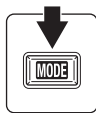

- 2 Press the shutter-release button all the way down to start recording.



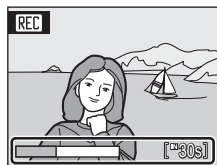

Camera focuses on subject in center of frame.

A progress bar at the bottom of the monitor shows the amount of recording time remaining.



To end recording, press the shutter-release button all the way down a second time.



Recording Movies

- Flash mode ( 28) and exposure compensation ( 32) can only be used for time-lapse ( 64) movie. Macro mode ( 31) is available in all modes. Self-timer ( 30) cannot be used.
- Flash mode, macro mode, and exposure compensation settings cannot be applied or changed while movies are being recorded. Apply or change settings as necessary before movie recording begins.
- Optical zoom cannot be applied while movies are recorded. Digital zoom cannot be used just before recording a movie, but up to 2x digital zoom can be applied while movies are recorded (except for time lapse movie).

Changing Movie Settings





- **Movie options**, **Electronic VR** or **Autofocus mode** can be changed ( 62).
- When **Movie options** is set to **Time-lapse movie** , movies are recorded without sound.

The Movie Menu





Movie options, Electronic VR or Autofocus mode (📷 63) settings can be changed from the movie menu. Press **MENU** in movie mode to display the movie menu and use the multi selector to modify and apply settings.

Selecting Movie Options

The movie menu offers the options shown below.

Option	Image size and frame rate
 TV movie 640★ (default setting)	Image size: 640 × 480 pixels Frame rate: 30 frames per second
 Small size 320★	Image size: 320 × 240 pixels Frame rate: 30 frames per second
 Small size 320	Image size: 320 × 240 pixels Frame rate: 15 frames per second
 Time-lapse movie★ (📷 64)	The camera automatically takes pictures at intervals and joins them into a silent movie. Image size: 640 × 480 pixels Frame rate: 30 frames per second

Movie Options and Maximum Movie Length and Frames

Option	Internal memory (approx. 50 MB)	Memory card (256 MB)
 TV movie 640★ (default setting)	45 sec.	3 min. 40 sec.
 Small size 320★	1 min. 30 sec.	7 min. 20 sec.
 Small size 320	2 min. 57 sec.	14 min. 20 sec.
 Time-lapse movie★ (📷 64)	534 frames	1,800 frames per movie

* Movies can be as long as free space in the internal memory or on the memory card allows. All figures are approximate. Maximum movie length or frames varies with make of memory card. The maximum file size for movies is 2 GB. Even if the memory card has a capacity greater than 4 GB, the camera displays the maximum movie length for the file size of 2 GB.

More Information

Electronic VR



Enable or disable electronic VR for movie recording.

Option	Description
 On (default setting)	Reduce the effects of camera shake in all movie modes except Time-lapse movie ★.
OFF Off	Electronic VR is not enabled.

At settings other than **Off**, the electronic vibration reduction icon is displayed in the monitor ( 6).

Autofocus mode

Choose how the camera focuses in movie mode.

Option	Description
 Single AF (default setting)	Camera focuses when shutter-release button is pressed halfway and locks at this position during shooting.
 Full-time AF	Camera focuses continuously until focus is acquired and locked. To prevent sound of camera focusing from interfering with recording, use of Single AF is recommended.

Time-Lapse Movies

Record flowers opening or butterflies emerging from cocoons.

- 1** Use the multi selector to choose **Movie options** from the movie menu and press **OK**.

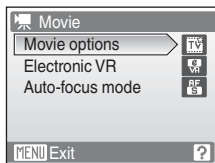

- 2** Choose **Time-lapse movie** and press **OK**.

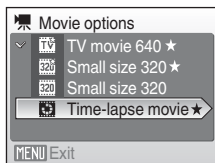

- 3** Choose the interval between shots and press **OK**.

Choose from intervals between 30 seconds and 60 minutes.

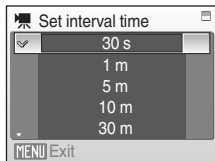

- 4** Press **MENU**.

The camera returns to shooting mode.



- 5** Press the shutter-release button all the way down to start recording.

Monitor turns off and power-on lamp blinks between shots.
Monitor reactivates automatically for the next shot.

- 6** Press the shutter-release button all the way down a second time to end recording.

Recording will automatically stop if the internal memory or memory card becomes full, or when 1,800 frames have been recorded. A 1,800-frame movie has a playback time of 60 seconds.

✓ Time-Lapse Movie

- Flash mode (📷 28), macro mode (📷 31), and exposure compensation (📷 32) cannot be adjusted after the first picture is taken. Apply the appropriate settings before shooting begins.
- To prevent the camera from turning off unexpectedly during recording, use a fully charged battery or the AC Adapter EH-62E (sold separately).

Movie Playback

In full-frame playback mode (F26), movies are recognized by the Movie options icon (F62). To play a movie, display it in full-frame playback mode and press **OK**.



Use the zoom buttons to adjust playback volume. Playback controls appear at the top of the monitor. Press the multi selector ◀ or ▶ to choose a control, then press **OK** to perform the selected operation. The following operations are available.

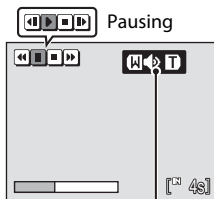

Volume indicator
During playback

To	Press	Description	
Rewind	◀	Rewind movie. Playback resumes when OK is released.	
Advance	▶	Advance movie. Playback resumes when OK is released.	
Pause	⏸	Pause playback. While paused, use the multi selector to advance or rewind the movie. The following operations can be performed while playback is paused.	
		◀	Rewind movie by one frame. Rewind continues while OK is pressed.
		▶	Advance movie by one frame. Advance continues while OK is pressed.
	▶	Resume playback.	
End	■	End playback and return to full-frame playback.	

Deleting Movie Files

Press **⏏** when playing a movie, or when displayed in full-frame playback mode (F26), or when selected in thumbnail (F46) playback mode. A confirmation dialog is displayed. Choose **Yes** and press **OK** to delete the movie, or choose **No** and press **OK** to return to the normal playback display without deleting the movie.



Making Voice Recordings

Audio voice recordings can be recorded over the built-in microphone and played back over the built-in speaker.

- 1 Enter voice recording mode by pressing **MODE** in shooting mode, selecting  (use the multi selector), and then pressing **OK**.

The length of recording that can be made will be displayed.

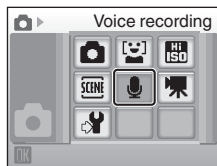
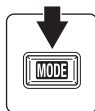

- 2 Press the shutter-release button all the way down to start recording.

The indicator lamp lights during recording. After about 30 seconds, the camera's auto off function is enabled and the monitor turns off.

See, "Operations During Recording" (📖 68) for more information.

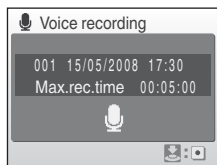

- 3 Press the shutter-release button all the way down a second time to end recording.





Recording will end automatically if the internal memory or memory card becomes full, or after five hours of recording on the memory card.

More Information

See, "Image/Sound File and Folder Names" (📖 124) for more information.

Operations During Recording





To	Press	Description
Reactivate the monitor		If the monitor has turned off, press  to reactivate.
Pause/resume recording		Press once to pause recording; indicator lamp will blink.
Create index*		During recording, press the multi selector to create index. Camera can skip to any index during playback. Start of recording is index number one; other numbers are assigned in ascending order, to a maximum of 98.
End recording		Press the shutter-release button all the way down a second time to end recording.

* The copied files can be played back using QuickTime or any other WAV-compatible audio player. Note that index points created with the camera cannot be used when voice recordings are played back on computers.

Playing Voice Recordings

- 1 Enter sound file playback mode by pressing **MODE** in playback mode, selecting  (use the multi selector), and then pressing **OK**.

Voice recordings can also be played back by pressing  in voice recording mode ( 67) to display the select sound file screen.

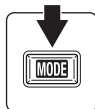

- 2 Choose the desired file and press **OK**.

The selected file will be played back.

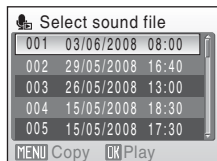

Operations During Playback

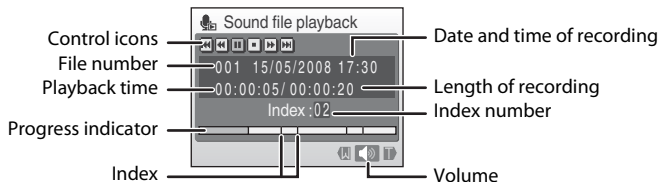

Use the zoom buttons to adjust playback volume.

Playback controls appear at the top of the monitor. Press the multi selector ◀ or ▶ to choose a control, then press **OK** to perform the selected operation. The following operations are available.

To	Press	Description
Rewind	◀◀	Rewind voice recording. Playback resumes when OK is released.
Advance	▶▶	Advance voice recording. Playback resumes when OK is released.
Skip to previous index	◀◀◀	Skip to previous index.
Skip to next index	▶▶▶	Skip to next index.
Pause	⏸	Pause playback.
	▶	The following operations can be performed while playback is paused: Resume playback.
End	◻	End playback and return to the sound file selection screen.

Deleting Sound Files

Press **Del** during playback or after selecting a sound file (use the multi selector). A confirmation dialog will be displayed. To delete the file, choose **Yes** and press **OK**. To cancel deletion, choose **No** and press **OK**.

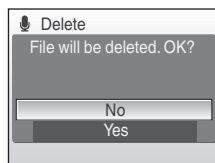

Copying Voice Recordings

Copy voice recordings between the internal memory and a memory card. This option is available only when a memory card is inserted.

- 1 Press **MENU** in the select sound file screen (☒ 69, step 2).

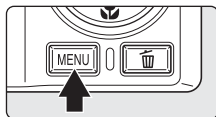

- 2 Use the multi selector to choose the option and press **OK**.

IN → **OUT**: Copy recordings from internal memory to memory card

OUT → **IN**: Copy recordings from memory card to internal memory

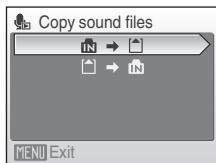

- 3 Choose the copy option and press **OK**.

Selected files: Proceed to step 4

Copy all files: Proceed to step 5

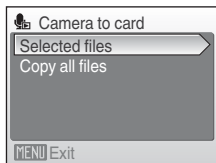

- 4 Choose the desired file.

Press the multi selector **▶** to select the file (☑). Press the multi selector **▶** again to cancel the selection.

- Multiple files can be selected.
- Press **OK** to finalize file selection.

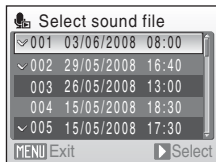

- 5 When a confirmation dialog is displayed, choose **Yes** and press **OK**.

Copying starts.

Voice Recordings

The COOLPIX S550 may be unable to play or copy sound files created with another make of camera.

No sound file. Message

If there are no sound files stored on the memory card when **IN** is selected (☒ 69, step 1), the message **No sound file.** will be displayed. Press **MENU** to display the copy sound files screen, and copy the sound files stored in the camera's internal memory to the memory card.

Connecting to a TV

Connect the camera to a television using the supplied audio video/USB cable to play back pictures on the television.

1 Turn off the camera.

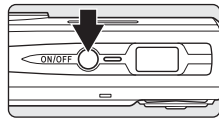

2 Connect the camera to the TV using the supplied audio video/USB cable.

Connect the yellow plug to the video-in jack on the TV, and the white plug to the audio-in jack.

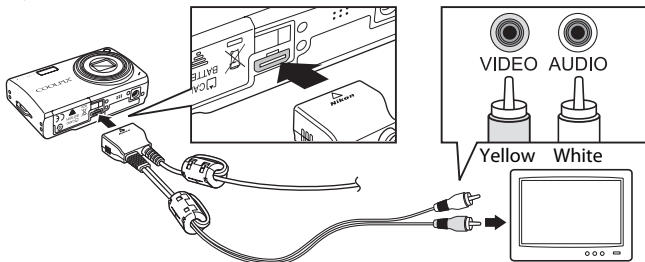

3 Tune the television to the video channel.

See the documentation provided with your television for details.

4 Hold down to turn on the camera.

The camera enters playback mode, and the pictures taken will be displayed on the television.

While connected to the TV, the camera monitor will remain off.

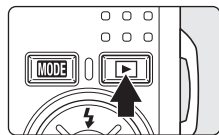

Connecting an AV Cable

- When connecting the AV cable, be sure that the camera connector is oriented correctly. Do not use force when connecting the AV cable to the camera. When disconnecting the AV cable, do not pull the connector at an angle.
- When connecting to a TV, do not use the audio video/USB cable's USB connector. If the USB connector is inserted in a computer or printer's USB port, be sure to disconnect it.

Video Mode

Be sure that the camera's video mode setting conforms to the standard used by your television. The video mode setting is an option set in the setup menu ( 105) > **Video mode**. ( 118)

Connecting to a Computer

Use the supplied audio video/USB cable to connect the camera to a computer, and copy (transfer) pictures to a computer with the supplied Nikon Transfer software.

Before Connecting the Camera

Install the Software

Before connecting the camera to a computer, software, including Nikon Transfer and Panorama Maker for creating panorama images, must be installed from the supplied Software Suite CD. For more information on installing the software, refer to the *Quick Start Guide*.

Operating Systems Compatible with COOLPIX S550

Windows

Preinstalled versions of Windows Vista (32-bit Home Basic/Home Premium/Business/Enterprise/Ultimate editions), Windows XP Service Pack 2 (Home Edition/Professional)

If your computer is running Windows 2000 Professional, use a card reader or similar device to transfer pictures stored on the memory card to the computer (75).

Macintosh

Mac OS X (version 10.3.9, 10.4.11)

Refer to the Nikon website for the latest information on operating system compatibility.

Note on Power Source

When connecting the camera to a computer or printer, use a fully charged battery to prevent the camera from turning off unexpectedly.

If the AC Adapter EH-62E that is sold separately is used, COOLPIX S550 can be charged using the home electrical outlet. Do not use any other AC adapters as it will cause the camera to heat up or malfunction.

Transferring Pictures from a Camera to a Computer

- 1 Start the computer to which Nikon Transfer was installed.
- 2 Turn off the camera.
- 3 Connect the camera to the computer using the supplied audio video/USB cable.

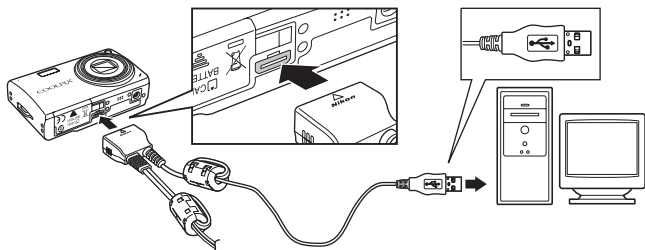

- 4 Turn on the camera.

Windows Vista

When the AutoPlay dialog is displayed, select **Copy pictures to a folder on my computer using Nikon Transfer**. To bypass this dialog in the future, check **Always do this for this device**. Nikon Transfer will start.

Windows XP

When the AutoPlay dialog is displayed, select **Nikon Transfer Copy pictures to a folder on my computer**, and click **OK**. Nikon Transfer will start. To bypass this dialog in the future, check **Always use this program for this action**. Nikon Transfer will start.

Mac OS X

Nikon Transfer will start automatically if **Yes** was selected in the Auto-Launch setting dialog when Nikon Transfer was first installed.

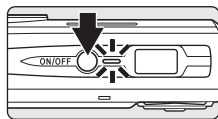

✓ Connecting the Audio Video/USB Cable

When connecting the audio video/USB cable, be sure that the connectors are oriented correctly. Do not use force when connecting the audio video/USB cable. When disconnecting the audio video/USB cable, do not pull the connector at an angle.

Connection may not be recognized when the camera is connected to a computer via a USB hub.

5 Transfer pictures when Nikon Transfer has finished loading.

Click **Start Transfer** in Nikon Transfer. At the default setting, all pictures are transferred to the computer.

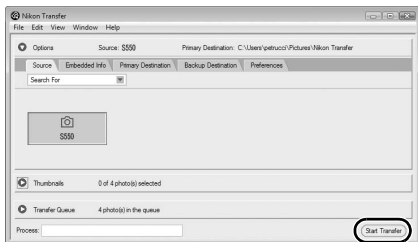

Start Transfer button

At the Nikon Transfer default setting, the folder to which pictures are transferred is automatically opened when transfer is complete.

For more information on using Nikon Transfer, refer to help information contained in Nikon Transfer.

6 Disconnect the camera when transfer is complete.

Turn the camera off and disconnect the audio video/USB cable.

For Users of Windows 2000 Professional

Use a card reader or similar device to transfer the pictures stored on the memory card to the computer. If the memory card has a capacity greater than 2 GB, or is SDHC-compliant, the intended device must support these features of the memory card.

- At the Nikon Transfer default settings, Nikon Transfer will start automatically when a memory card is inserted into the card reader or similar device. See step 5 above to transfer pictures.
- Do not connect the camera to the computer. If the camera is connected to the computer, the **Found New Hardware Wizard** dialog will be displayed. Select **Cancel**, close the dialog, and disconnect the camera from the computer.
- To transfer pictures stored in the camera's internal memory to the computer, the pictures must first be copied to a memory card using the camera (71, 99, 104).



Using Standard OS Operations to Open Camera Files

- Navigate to the folder on the computer's hard disk to which pictures were saved and open a picture in the viewer supplied with your operating system.
- Sound files copied to the computer can be played back using QuickTime or any other WAV-compatible audio player.



Panorama Creation with Panorama Maker

- Use a series of pictures taken using the **Panorama assist** option in scene mode (📷 40) to create a single panorama photo with Panorama Maker.
- Panorama Maker can be installed to a computer using the supplied Software Suite CD. After installation is complete, follow the procedure described below to start Panorama Maker.

Windows

Open **All Programs (Programs** under Windows 2000) from the **Start** menu > **ArcSoft Panorama Maker 4** > **Panorama Maker 4**.

Macintosh

Open Applications by selecting **Applications** from the **Go** menu, and double-click the **Panorama Maker 4** icon.

- For more information on using Panorama Maker, refer to the on-screen instructions and help information contained in Panorama Maker.

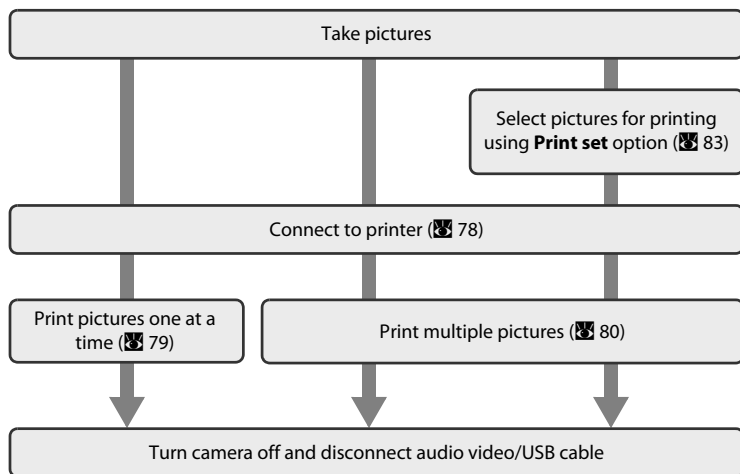

Image File Names and Folder Names

See, "Image/Sound File and Folder Names" (📷 124) for more information.

Connecting to a Printer

Users of PictBridge-compatible (🔑 143) printers can connect the camera directly to the printer and print pictures without using a computer.



✔ Note on Power Source

When connecting the camera to a computer or printer, use a fully charged battery to prevent the camera from turning off unexpectedly.

If the AC Adapter EH-62E that is sold separately is used, COOLPIX S550 can be charged using the home electrical outlet. Do not use any other AC adapters as it will cause the camera to heat up or malfunction.

💡 Printing Pictures

In addition to printing pictures transferred to a computer from your personal printer and printing over a direct camera-to-printer connection, the following options are also available for printing pictures:

- Insert a memory card into a DPOF-compatible printer's card slot
- Take a memory card to a digital photo lab

For printing using these methods, specify the pictures and the number of prints each using your camera's **Print set** menu (🔑 83).

Connecting the Camera and Printer

- 1 Turn off the camera.

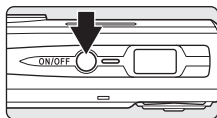

- 2 Turn on the printer.

Check printer settings.

- 3 Connect the camera to the printer using the supplied audio video/USB cable.

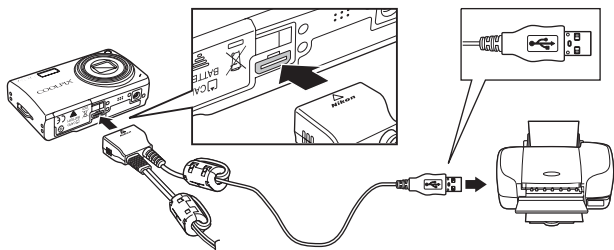

- 4 Turn on the camera.

When connected correctly, the PictBridge startup screen

① will be displayed in the camera monitor. Then the print selection screen will be displayed ②.

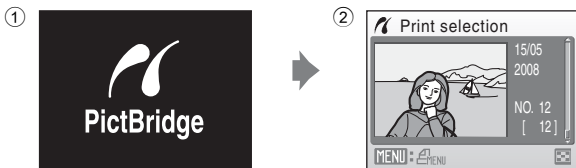
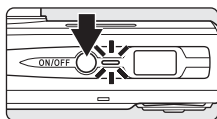

✓ Connecting the Audio Video/USB Cable

When connecting the audio video/USB cable, be sure that the connectors are oriented correctly. Do not use force when connecting the audio video/USB cable. When disconnecting the audio video/USB cable, do not pull the connector at an angle.

Printing Pictures One at a Time

After connecting the camera to the printer correctly (❗ 78), print pictures by following the procedure below.

- 1 Use the multi selector to choose the desired picture and press **OK**.

Press **W** (📄) to display 12 thumbnails, and **T** (🔍) to switch back to full-frame playback.

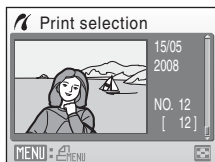

- 2 Choose **Copies** and press **OK**.

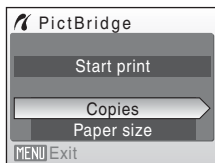

- 3 Choose the number of copies (up to nine) and press **OK**.

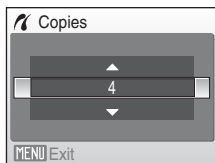

- 4 Choose **Paper size** and press **OK**.

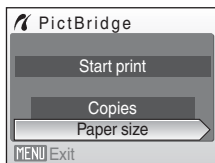

- 5 Choose the desired **Paper size** and press **OK**.

To specify paper size using printer settings, choose **Default** in the paper size menu.

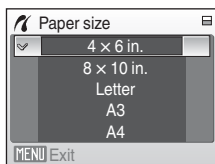

6 Choose **Start print** and press **OK**.

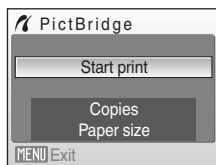

7 Printing starts.

Monitor display returns to that shown in step 1 when printing is complete.

To cancel before all copies have been printed, press **OK**.

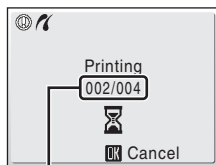

Current print/
total number of prints

Printing Multiple Pictures

After connecting the camera to the printer correctly (see 78), print pictures by following the procedure below.

1 When the print selection screen is displayed, press **MENU**.

The print menu is displayed.

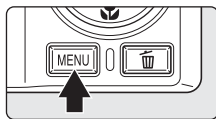

2 Use the multi selector to choose **Paper size** and press **OK**.

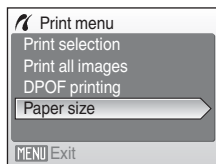

3 Choose the desired **Paper size** and press **OK**.

To specify paper size using printer settings, choose **Default** in the paper size menu.

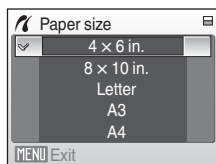

4 Choose **Print selection**, **Print all images** or **DPOF printing** and press **OK**.

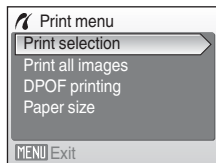

Print selection

Choose the pictures and number of copies (up to nine) of each.

Press the multi selector ◀ or ▶ to select pictures, and press ▲ or ▼ to set the number of copies for each.

Pictures selected for printing can be recognized by the check mark (✓) and the numeral indicating the number of copies to be printed. A check mark is not displayed with pictures for which no copies have been specified and these pictures will not be printed.

Press **T** (Q) to switch to full-frame playback.

Press **W** (E) to switch back to thumbnail display.

Press **OK** when setting is complete.

The menu shown at right will be displayed.

To print, choose **Start print** and press **OK**.

Choose **Cancel** and press **OK** to return to the print menu.

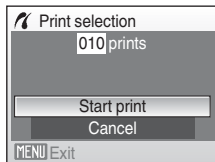
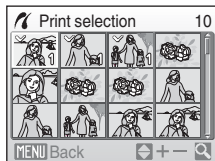

Print all images

All pictures stored in the internal memory, or on the memory card, are printed one at a time.

The menu shown at right will be displayed.

To print, choose **Start print** and press **OK**.

Choose **Cancel** and press **OK** to return to the print menu.

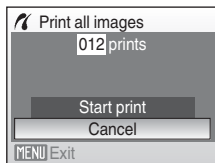

DPOF printing

Print pictures for which a print order was created in **Print set** (83).

- The menu shown at right will be displayed.
- To print, choose **Start print** and press **OK**.
- Choose **Cancel** and press **OK** to return to the print menu.
- To view the current print order, choose **View images** and press **OK**. To print pictures, press **OK** again.

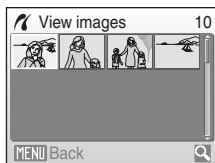
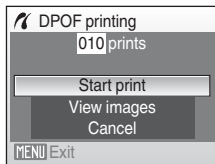

5 Printing starts.

Monitor display returns to the print menu (step 2) when printing is complete.

To cancel before all copies have been printed, press **OK**.

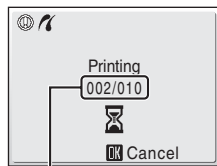

Current print/
total number of prints

✓ Paper Size

The camera supports the following paper sizes: **Default** (the default paper size for the current printer), **3.5 × 5 in.**, **5 × 7 in.**, **100 × 150 mm**, **4 × 6 in.**, **8 × 10 in.**, **Letter**, **A3**, and **A4**. Only sizes supported by the current printer will be displayed. To specify paper size using printer settings, choose **Default** in the paper size menu.

Creating a DPOF Print Order: Print Set

The **Print set** option in the playback menu is used to create digital “print orders” for printing on DPOF-compatible devices (📄 143).

When the camera is connected to a PictBridge-compatible printer, pictures can be printed from the printer according to the DPOF print order you have created for pictures on the memory card. If the memory card is removed from the camera, you can create the DPOF print order for pictures in the internal memory and print pictures according to the DPOF print order.

1 Press **MENU** in playback mode.

The playback menu is displayed.

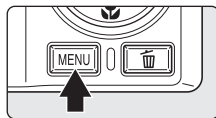

2 Use the multi selector to choose **Print set** and press **OK**.

The print set menu is displayed.



3 Choose **Select images** and press **OK**.

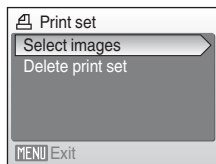

4 Choose the pictures and number of copies (up to nine) of each.

Press the multi selector ◀ or ▶ to choose the desired pictures. Press ▲ or ▼ to set the number of copies for each.

Pictures selected for printing can be recognized by the check mark (✔) icon and the numeral indicating the number of copies to be printed. A check mark is not displayed with pictures for which no copies have been specified and these pictures will not be printed.

Press **T** (📄) to switch to full-frame playback.

Press **W** (📄) to switch back to thumbnail display.

Press **OK** when setting is complete.

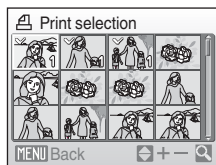



5 Choose whether or not to also print shooting date and photo information.

Choose **Date** and press **OK** to print date of recording on all pictures in the print order.

Choose **Info** and press **OK** to print photo information (shutter speed and aperture) on all pictures in the print order.

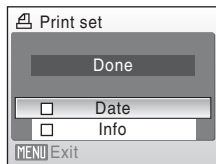

Choose **Done** and press **OK** to complete the print order and exit.

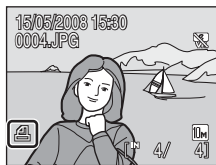

Pictures selected for printing are recognized by the  icon displayed with playback.



Notes on Printing Shooting with Date and Photo Information

- When the **Date** and **Info** options are enabled in the print set menu, shooting date and photo information are printed on pictures when a DPOF-compatible ( 143) printer which supports printing of shooting date and photo information is used.
- Photo information cannot be printed when the camera is connected directly to a printer, via the supplied audio video/USB cable, for DPOF printing ( 80).
- **Date** and **Info** are reset each time the print set menu is displayed.

Deleting All Print Orders

Choose **Delete print set** in step 3 and press **OK**. Print orders for all pictures will be deleted.

Note on the Print Set Date Option

The date and time printed on pictures with DPOF printing when **Date** in the **Print set** menu is enabled, are those recorded with the picture when it was taken. Date and time printed using this option are not affected when the camera's date and time setting are changed from the setup menu after pictures are recorded.

Date Imprint















When date and time of recording are imprinted on pictures using the **Date imprint** option ( 112) in the setup menu, pictures with the date and time imprinted on them can be printed from printers that do not support printing of the date and time on pictures.

Only the **Date imprint** date and time on pictures will be printed, even if **Print set** is enabled with **Date** selected in the print set screen.



Shooting Options: The Shooting Menu

The shooting menu and high sensitivity menu contain the following options.

	Image mode ¹	 87
	Choose image size and quality.	
	White balance ²	 89
	Match white balance to the light source.	
	Continuous ²	 91
	Change settings for Continuous or BSS (best shot selector).	
	ISO sensitivity ³	 93
	Control camera's sensitivity to light.	
	Color options ²	 93
	Apply color effects to pictures as they are recorded.	
	AF area mode	 94
	Choose where the camera focuses.	
	Distortion control ²	 97
	Correct the distortion.	

¹ **Image mode** can change the settings for menus of other shooting modes (except movie menu).

² See the information on restrictions that may apply to these settings ( 98).

³ This setting cannot be set in the high sensitivity menu.

Displaying the Shooting Menu and High sensitivity Menu



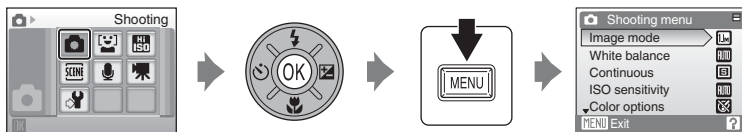



Enter (auto) or high sensitivity shooting mode by pressing **MODE** in shooting mode, selecting (auto) or (high sensitivity), and then pressing **OK**. Press **MENU** to display the shooting menu or high sensitivity menu.



- Use the multi selector to choose and apply settings (9).
- To exit the shooting or high sensitivity menu, press **MENU**.

Image Mode

Pictures taken with a digital camera are recorded as image files. The size of the files, and with it the number of images that can be recorded, depends on the size and quality of the images. Before shooting, choose an image mode according to how you plan to use the picture.

Option	Size (pixels)	Description
 High (3648★)	3,648 × 2,736	Highest quality, suitable for enlargements or high-quality prints. The compression ratio is approximately 1:4.
 Normal (3648) (default setting)	3,648 × 2,736	Best choice in most situations. The compression ratio is approximately 1:8.
 Normal (2592)	2,592 × 1,944	
 Normal (2048)	2,048 × 1,536	Smaller size allows more pictures to be stored. The compression ratio is approximately 1:8.
 PC screen (1024)	1,024 × 768	Suited to display on a computer monitor. The compression ratio is approximately 1:8.
 TV screen (640)	640 × 480	Suited to full-screen display on a television, or distribution by e-mail or the web. The compression ratio is approximately 1:8.
 16:9 (1920)	1,920 × 1,080	Pictures with an aspect ratio of 16:9 can be taken. The compression ratio is approximately 1:8.







The icon for the current setting is displayed in the monitor in shooting and playback modes ( 6, 7).

Image Mode

Changes made to these settings apply to all shooting modes (except movie menu).

Number of Exposures Remaining

The following table lists the approximate number of pictures that can be stored in internal memory and on a 256 MB memory card. Note that the number of pictures that can be stored will differ depending on the composition of the picture (due to JPEG compression). In addition, this number may differ depending on the make of memory card, even if the capacity for the memory card is the same.

Setting	Internal memory (approx. 50 MB)	Memory card ¹ (256 MB)	Print size (printed at 300 dpi; cm/in.) ²
 High (3648★)	10	50	31 × 23/12.2 × 9.1
 Normal (3648)	20	100	31 × 23/12.2 × 9.1
 Normal (2592)	40	195	22 × 16.5/8.7 × 6.5
 Normal (2048)	62	305	17 × 13/6.7 × 5.1
 PC screen (1024)	213	1,045	9 × 7/3.5 × 2.8
 TV screen (640)	401	1,965	5 × 4/2 × 1.6
 16:9 (1920)	91	445	16 × 9/6.3 × 3.5

¹ If the number of exposures remaining is 10,000 or more, the number of exposures remaining display shows **9999**.

² Print sizes are calculated by dividing the number of pixels by printer resolution (dpi) and multiplying by 2.54 cm (1 in.). However, at the same image size, pictures printed at higher resolutions will print smaller than the size indicated, and those printed at lower resolutions will print larger than the size indicated.

WB White Balance

The color of light reflected from an object varies with the color of the light source. The human brain is able to adapt to changes in the color of the light source, with the result that white objects appear white whether seen in the shade, direct sunlight, or under incandescent lighting. Digital cameras can mimic this adjustment by processing images according to the color of the light source. This is known as “white balance.” For natural coloration, choose a white balance setting that matches the light source before shooting. Although the default setting, **Auto**, can be used under most types of lighting, you can apply the white balance setting suited to a particular light source to achieve more accurate results.

Auto (default setting)

White balance automatically adjusted to suit lighting conditions. Best choice in most situations.

Preset manual

Neutral-colored object used as reference to set white balance under unusual lighting conditions. Please refer to “Preset Manual” for more information ( 90).

Daylight

White balance adjusted for direct sunlight.

Incandescent

Use under incandescent lighting.

Fluorescent

Use under most types of fluorescent lighting.

Cloudy

Use when taking pictures under overcast skies.

Flash

Use with the flash mode.

The effects of the selected option can be previewed in the monitor. At settings other than **Auto**, the icon for the current setting is displayed in the monitor ( 6).

Flash Mode

At white-balance settings other than **Auto** or **Flash**, turn the flash off (  28).

Preset Manual

Preset manual is used with mixed lighting or to compensate for light sources with a strong color cast (for example, to make pictures taken under a lamp with a red shade look as though they had been taken under white light).

1 Place a white or gray reference object under the lighting that will be used during shooting.

2 Use the multi selector to choose **PRE Preset manual** in the White balance menu, and press **OK**.

The camera zooms in.

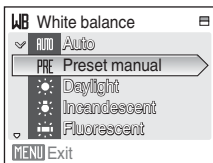

3 Choose **Measure**.

To apply the most recently measured value for preset manual, choose **Cancel** and press **OK**.

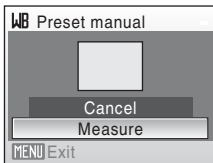

4 Frame the reference object.

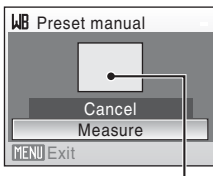

Reference object frame

5 Press **OK**.

The shutter is released and the new white-balance value is set. No pictures are recorded.

✓ Note on Preset Manual

Regardless of the flash mode selected, the flash will not fire when **OK** is pressed in step 5. Therefore, the camera cannot measure a value for preset manual for when the flash is used.

Continuous

Change settings to Continuous or BSS (best shot selector). Flash will be switched off for **Continuous**, **BSS** or **Multi-shot 16**, and focus, exposure and white balance are fixed at the values for the first picture in each series.

Single (default setting)

One shot is taken each time shutter-release button is pressed.

Continuous

While the shutter-release button is held down, up to 8 pictures are taken at a rate of about 1.0 frames per second (fps) when **Image mode** is set to  **Normal (3648)**.

BSS BSS (Best Shot Selector)

The “best shot selector” is recommended when shooting with the flash off or the camera zoomed in, or in other situations in which inadvertent motion can result in blurred pictures. When BSS is on, the camera takes up to ten pictures while the shutter-release button is held down. The sharpest picture in the series is automatically selected and saved.

Multi-shot 16

Each time shutter-release button is pressed, camera takes 16 shots at about 1.0 frames per second and arranges them in a single picture with **Image mode** setting  **Normal (2592)**.

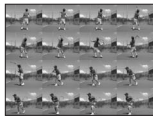

Intvl timer shooting

Camera takes pictures (up to 1,800 frames) automatically at specified interval ( 92).

At settings other than **Single**, the indicator for the current setting is displayed in the monitor ( 6).

Note on Continuous Shooting

- The maximum frame rate with continuous shooting may vary, depending upon the current image mode setting and the memory card used.
- Digital zoom cannot be used in **Multi-shot 16**.

Note on BSS

- **BSS** may not produce the desired results if the subject moves or the composition changes while the shutter-release button is pressed all the way down.

Interval Timer Photography

Pictures are taken automatically at specified intervals. Choose from intervals between 30 seconds and 60 minutes.

- 1 Use the multi selector to choose **Intvl timer shooting** in the Continuous menu, and press **OK**.

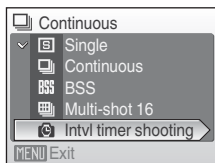

- 2 Choose interval between shots and press **OK**.

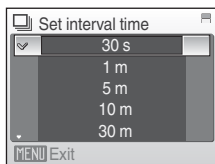

- 3 Press **MENU**.

The camera returns to shooting mode.

- 4 Press the shutter-release button all the way down to take the first picture and initiate interval timer shooting.

Monitor turns off and power-on lamp blinks between shots.

The monitor turns on automatically right before the next shot is taken.

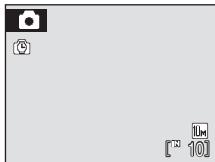

- 5 Press the shutter-release button all the way down a second time to end recording.

Recording will end automatically if the internal memory or memory card becomes full, or when 1,800 pictures have been taken.

✔ Note on Interval Timer Shooting

- To prevent the camera from turning off unexpectedly during recording, use a fully charged battery.
- To power the camera continuously for extended periods, use an AC Adapter EH-62E (available separately from Nikon). **Do not, under any circumstances, use another make or model of AC adapter.** Failure to observe this precaution could result in overheating or in damage to the camera.

📖 More Information

See, "Image/Sound File and Folder Names" (📖 124) for more information.

ISO ISO Sensitivity

Sensitivity is a measure of how quickly the camera reacts to light. The higher the sensitivity, the less light needed to make an exposure. Although a high ISO rating is suited for taking pictures of subjects in action or in poor lighting, high sensitivity is often associated with “noise” - randomly spaced, brightly colored pixels concentrated in dark parts of the image.

Auto (default setting)

Sensitivity is ISO 64 under normal conditions; when lighting is poor and the flash is off, the camera compensates by raising sensitivity to a maximum of ISO 800.

64, 100, 200, 400, 800, 1600, 2000

Sensitivity will be locked at the specified value.

At the settings other than **Auto**, the current setting is displayed in the monitor (📷 6). If **Auto** is selected and the sensitivity is raised above ISO 64, the **ISO** icon will be displayed (📷 29).

🎨 Color Options

Make colors more vivid or record pictures in monochrome.

🎨 Standard color (default setting)

Use for pictures exhibiting natural color.

🎨 Vivid color

Use to achieve a vivid, “photoprint” effect.

🎨 Black-and-white

Record pictures in black-and-white.

🎨 Sepia

Record pictures in sepia tones.

🎨 Cyanotype

Record pictures in cyan-blue monochrome.

The effects of the selected option can be previewed in the monitor. At settings other than **Standard color**, the icon for the current setting is displayed in the monitor (📷 6).

[+] AF Area Mode

Use this option to determine where the camera focuses. When digital zoom is in effect, focus will be on the center of the screen regardless of the settings used.



Face priority (default setting)

When the camera recognizes a face (front view), the camera will focus on that face. See “Face Priority” (96) for more information. If more than one face is recognized, focus will be on the face closest to the camera.

When shooting non-human subjects or when no faces are recognized, **AF area mode** will switch to **Auto**, and the camera will automatically select the focus area (one of nine) containing the subject closest to the camera.



Auto

Camera automatically selects the focus area (one of nine) containing the subject closest to the camera. Press the shutter-release button halfway to activate the focus area. When the shutter-release button is pressed halfway, the focus area selected by the camera will be displayed in the monitor.

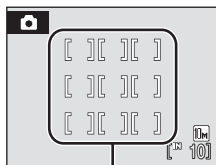

Focus area



Manual

This option is suited to situations in which the intended subject is relatively still and not positioned in the center of the frame.

Press the multi selector ▲, ▼, ◀ or ▶ to select from 99 focus areas in the frame. Pictures can be taken while focus-area selection screen is displayed.

To end focus-area selection and adjust the flash, macro, self-timer and exposure compensation settings, press **OK**. To return to the focus-area selection screen, press **OK**.

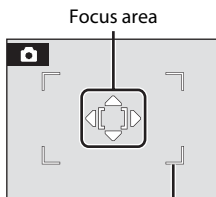

Selectable focus areas

Center

Camera focuses on subject in center of frame.
Center focus area is used.

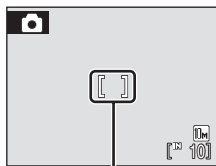

Focus area

Focus Lock

To focus on off-center subjects when **Center** is selected for **AF area mode**, use focus lock as described below.

- 1 Position the subject in the center of the frame.
- 2 Press the shutter-release button halfway.
 - Confirm that the focus area is green.
- 3 Continue holding down the shutter-release button halfway and recompose the picture.
 - Be sure that the distance between the camera and the subject does not change.
- 4 Press the shutter-release button the rest of the way down to shoot.



More Information

See, "Autofocus" (📖 25) for more information.

Face Priority

When the camera is pointed at a people's face, the camera automatically recognizes the face and will focus on it.

In the following cases, the face priority feature will take effect.

- When AF area mode is set to **Face priority** (default setting) (📷 94)
- When Scene mode is set to **Portrait** (📷 35) or **Night portrait** (📷 36)
- When the smile mode is selected (📷 43)

1 Frame a picture

When the camera recognizes a face (front view), that face will be framed by a yellow double border.



If more than one face is recognized, the operations will vary with the shooting modes as follows.

Shooting mode	Faces framed by a double border	The number of faces to be recognized
📷 (auto) mode, high sensitivity shooting mode (Face Priority)	The face positioned at the nearest to the camera. * The other faces are framed by a single border.	Up to 12
Scene mode: Night portrait		
Scene mode: Portrait	The face positioned at the nearest center of the screen. * The other faces are framed by a single border.	Up to 3
Smile mode		

2 Press the shutter-release button halfway

Focus will be on the face framed by the double border. The double border will glow green once focus has been locked.



When the camera is unable to focus, the double border will blink. Press the shutter-release button halfway and try focusing again.

Press the shutter-release button the rest of the way down to take the picture.



You don't need to press the shutter-release button halfway in the smile mode. If the camera detects the smiling face, the shutter is automatically released (📷 43).

Notes about Face Priority

- In **Face priority** or the smile mode, if the shutter-release button is pressed halfway when no faces are recognized, AF area mode will be set to **Auto**.
- In the **Portrait** and **Night portrait** settings of scene mode, if the shutter-release button is pressed halfway when no faces are recognized, focus will be set on the center of the screen.
- The camera may be unable to detect faces in the following situations:
 - When faces are partially hidden by sunglasses or other obstructions
 - When faces take up too much or too little of the frame
 - When the subject is not looking directly at the camera
- The camera's ability to detect faces depends on a variety of factors, including whether or not the subject is facing the camera.
- In some rare cases shooting subjects with which autofocus may not perform as expected (, 25), the subject may not be in focus despite the fact that the double border glows green. Should this occur, switch to AF area mode (**manual** or **center**), refocus on another subject positioned at the same distance from the camera as the actual portrait subject, and use focus lock (, 95).
- Pictures taken in Face Priority, while in full-frame playback, will be rotated (if necessary) and displayed.

Distortion Control

Specify whether or not the distortion is corrected. Enabling distortion control reduces the size of the frame.

On

Distortion at frame peripheries is corrected.

Off (default setting)

No distortion correction performed.

At settings other than **Off**, the icon for the current setting is displayed in the monitor (, 6).

Restrictions on Camera Settings

Restrictions apply to the following settings in  (auto) mode.

Flash mode

Flash turns off at **Continuous** settings of **Continuous**, **BSS** or **Multi-shot 16**.
Applied setting is restored when **Single** or **Intvl timer shooting** is selected.

Self-timer

If self-timer is on, only one shot will be taken when shutter is released, regardless of settings chosen for **Continuous**.
Applied **Continuous** settings are restored when picture is taken or self-timer is turned off.

Continuous

If **Continuous** setting is set to **Multi-shot 16**, **Image mode** will be set to  **Normal (2592)**.
If **Continuous** mode is restored to any setting other than **Multi-shot 16** the settings for **Image mode** will also be restored.

White balance



















White balance is automatically set to **Auto** and cannot be adjusted when **Black-and-white**, **Sepia** or **Cyanotype** is selected for **Color options**.
Applied white balance setting is restored when **Standard color** or **Vivid color** is selected.

Distortion control

When **Distortion control** is set to **On**, **Continuous** will change to **Single**. After that, if **Distortion control** is returned to **Off**, **Continuous** remains **Single**.

Playback Options: The Playback Menu

The playback menu contains the following options.

 D-Lighting  49
Enhances brightness and contrast in dark portions of pictures.
 Print set  83
Select pictures to print and the number of copies for each.
 Slide show  101
View pictures stored in the internal memory or on a memory card in an automatic slide show.
 Delete  102
Delete all or selected pictures.
 Protect  102
Protect selected pictures from accidental deletion.
 Rotate image  103
Change the orientation of a picture.
 Small pic.  52
Create a small copy of the current picture.
 Voice memo  53
Record and play voice memo.
 Copy  104
Copy files between memory card and internal memory.

Displaying the Playback Menu

Display the playback menu by pressing  and pressing **MENU**.

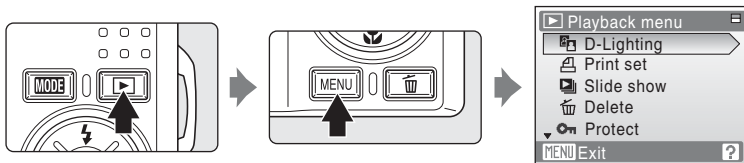

- Use the multi selector to choose and apply settings ( 9).
- To exit the playback menu, press **MENU**.

Selecting Multiple Pictures

The screen shown at right will be displayed in the menus (shown below) when choosing pictures.

Smile menu: Remove from list (🗑️ 45)

Playback menu: Print set (🖨️ 83), Delete (🗑️ 102), Protect (🔒 102), Rotate image (🔄 103), Picture Copy (📄 104)

Setup menu: Welcome screen (🏠 107)

Follow the procedure described below to choose the pictures.

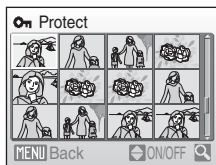

1 Press ◀ or ▶ to choose the desired picture.

Only one picture can be selected for **Rotate image** and **Welcome screen**. Proceed to step 3.

Press **T** (🔍) to switch to full-frame playback.

Press **W** (🖼️) to switch back to thumbnail display.

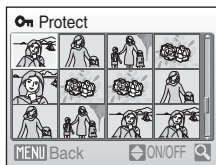

2 Press ▲ or ▼ to select ON or OFF (or the number of copies).

When **ON** is selected, a check mark (✓) is displayed in the top left corner of the current picture. Repeat steps 1 and 2 to select additional pictures.

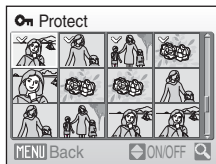

3 Press OK.

The setting is enabled.

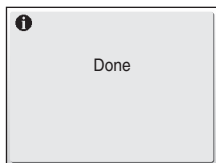

Slide Show

Play back pictures, stored in the internal memory or on a memory card, one by one in an automated “slide show.”

1 Use the multi selector to choose **Start** and press **OK**.

To change the interval between pictures, choose **Frame intvl**, select the desired interval time, and press **OK** before choosing **Start**.

To repeat the slide show automatically, enable **Loop** and press **OK** before choosing **Start**. The check mark (✓) will be added to the loop option when enabled.

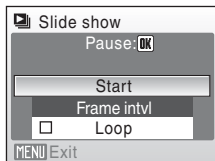

2 The slide show begins.

While the slide show is in progress, the following operations can be performed:

- Use the multi selector to switch pictures. Hold ◀ or ▶ down to fast forward or rewind.
- Press **OK** to pause the slide show.



3 Choose **End** or **Restart**.

When the slide show ends or is paused, choose **End** and press **OK** to return to the playback menu, or choose **Restart** to play the slide show again.

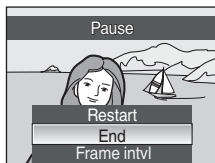

Notes on Slide Show

- Only the first frame of movies (📽 66) included in slide shows is displayed.
- Even if **Loop** is selected, the monitor can continuously display the Slide Show for up to 30 minutes (📽 116).

Delete

Delete selected pictures or all pictures.

Erase selected images

Delete selected pictures ( 100).



Erase all images

Delete all pictures.

Notes on Deletion

- Once deleted, pictures cannot be recovered. Transfer important images to a computer before deletion.
- Pictures marked with the  icon are protected and cannot be deleted.

Protect



Protect selected pictures from accidental deletion. See “Selecting Multiple Pictures” ( 100) for more information on using this function. Note, however, that formatting the camera’s internal memory or the memory card will permanently erase protected files ( 117).

Protected pictures are recognized by the  icon ( 7, 46) in playback mode.

Rotate Image

Set the picture orientation (vertical or horizontal frame) displayed on the camera monitor after the pictures are taken.

Pictures can be rotated 90° clockwise or counterclockwise.

When the image that can be rotated in the picture selection screen ( 100) is selected, the **Rotate image** screen appears. In this step, pressing the multi selector  or  rotates the image by 90°.

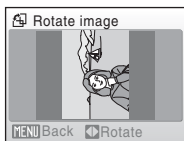

Rotate 90°
counterclockwise

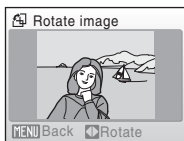

Rotate 90°
clockwise





Press  to select the displayed direction and the vertical / horizontal position data will be recorded on the picture.

Copy

Copy pictures between the internal memory and a memory card.

- 1 Select an option from the copy screen using the multi-selector and press **OK**.

: Copy pictures from internal memory to memory card.

: Copy pictures from memory card to internal memory.

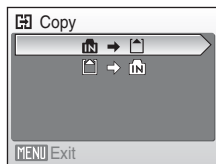



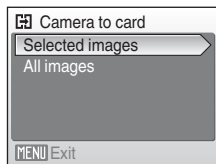

- 2 Select a copy option and press **OK**.

Selected images: Copy pictures selected from the picture selection screen ( 100).

All images: Copy all pictures.



Notes on Copying Pictures

- JPEG-, AVI-, and WAV-format files can be copied. Files recorded in any other format cannot be copied.
- If voice memos ( 53) are attached to pictures selected for copying, voice memos are copied with the pictures.
- Sound files recorded using Voice Recording ( 67) can be copied using the **Copy sound files** option ( 71) in sound file playback mode.
- Pictures taken with another make of camera or that have been modified on a computer cannot be copied.
- Edited copies have the same protection marking ( 102) as the original, but are not marked for printing ( 83).

Memory contains no images. Message

































If there are no pictures stored on the memory card when playback mode is applied, the message **Memory contains no images.** will be displayed. Press **MENU** to display the copy option screen, and copy the pictures stored in the camera's internal memory to the memory card.

More Information

See, "Image/Sound File and Folder Names" ( 124) for more information.

Basic Camera Setup: The Setup Menu

The setup menu contains the following options.

	Menu  106
	Choose how menus are displayed.
	Welcome screen  107
	Select screen displayed when camera is turned on.
	Date  108
	Set camera clock and choose home and destination time zones.
	Monitor settings  111
	Adjust monitor brightness and choose display style.
	Date imprint  112
	Imprint date or date counter on pictures.
	Electronic VR  114
	Specify the electronic vibration reduction setting for shooting still pictures.
	AF assist  115
	Enable or disable AF-assist illumination.
	Digital zoom  115
	Adjust settings for using digital zoom.
	Sound settings  116
	Adjust sound and volume settings.
	Auto off  116
	Set time before camera enters standby mode.
	Format memory/Format card  117
	Format internal memory or memory card.
	Language  118
	Choose the language used for camera monitor display.
	Video mode  118
	Adjust settings necessary for connection to television.
	Blink warning  118
	Set whether or not to detect human subjects with eyes closed when shooting pictures in the face priority ( 96).
	Reset all  120
	Restore camera settings to default values.
	Firmware version  122
	Display camera firmware version.

Displaying the Setup Menu

First, display the playback-mode or shooting-mode selection menu by pressing **MODE**. Then select  (use the multi selector), and press **OK**.



- Use the multi selector to choose and apply settings ( 9).
- To exit the setup menu, press **MODE**.

Menus

Choose the initial menu displayed.

Text (default setting)

Menus are displayed in list format.

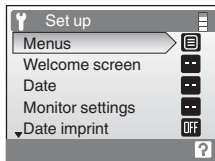

Icons

All menu items can be displayed in a single page.

Menu names

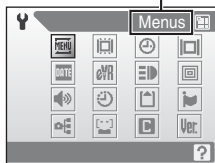

Welcome Screen

You can select the welcome screen to be displayed when the camera is turned on.

None (default setting)

No welcome screen will be displayed.



COOLPIX

Displays a welcome screen

Select an image

Select a picture in the internal memory or on the memory card for the welcome screen. Choose a picture in the picture selection screen and press .

As the selected image is stored in the camera, the image will appear in the welcome screen even if the original picture is deleted.

Pictures which are set as **16:9 (1920)** on **Image mode** setting ( 87) and images smaller than 320x240 edited by the crop ( 51) or small picture ( 52) function are not selectable.

Date



Set the camera clock and choose home and travel destination time zones.

Date

Set camera clock to current date and time.

See "Setting Display Language, Date and Time" ( 17) for more information.

Time zone

 (home time zone) can be specified and daylight saving enabled or disabled from **Time zone** options. When  (destination time zone) is selected, the time difference ( 110) is automatically calculated and the date and time in the selected region are recorded. Useful when travelling.

Setting Travel Destination Time Zone

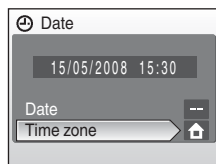

- 1 Use the multi selector to choose **Time zone** and press .

The time zone menu is displayed.



- 2 Choose  and press .

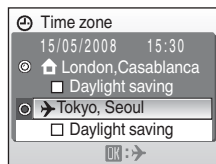

The date and time displayed on the monitor changes according to the region currently selected.

If daylight saving time is in effect, use the multi selector to choose **Daylight saving** and press , and then press . The time is automatically advanced one hour.

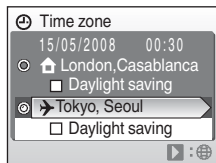

3 Press .

The travel destination menu is displayed.

**4** Choose the travel destination time zone and press .

The setting is enabled.

While the travel destination time zone is selected, the  icon will be displayed in the monitor when the camera is in shooting mode.

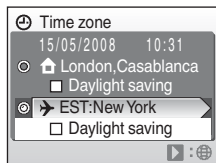
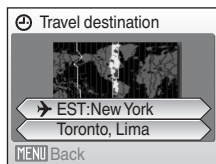

 **The Clock Battery**

The clock battery charges when the main battery is installed or an AC adapter is connected, and can provide several days of backup power after about ten hours of charging.

 **🏠 (Home Time Zone)**

- To switch to the home time zone, choose  in step 2.
- To change the home time zone, choose  in step 2 and perform steps 3 and 4, to set the home time zone.

 **Daylight Saving Time**

- If date and time are set when daylight saving time is not in effect: Turn **Daylight saving** on () when daylight saving time begins, to automatically advance the camera's clock one hour.
- If date and time are set with **Daylight saving** turned on () when daylight saving time is in effect: Turn **Daylight saving** off when daylight saving time ends, to automatically set the camera's clock back one hour.

Basic Camera Setup: The Setup Menu

Time Zones 17)

The camera supports the time zones listed below. For time differences not listed below, set the camera clock to local time. The table contains some locations that are not displayed on the camera's time zone map.

UTC +/-	Location	UTC +/-	Location
-11	Midway, Samoa	+1	Madrid, Paris, Berlin
-10	Hawaii, Tahiti	+2	Athens, Helsinki, Ankara
-9	Alaska, Anchorage	+3	Moscow, Riyadh, Kuwait, Manama, Nairobi
-8	PST (PDT): Los Angeles, Seattle, Vancouver	+4	Abu Dhabi, Dubai
-7	MST (MDT): Denver, Phoenix, La Paz	+5	Islamabad, Karachi
-6	CST (CDT): Chicago, Houston, Mexico City	+5.5	New Delhi
-5	EST (EDT): New York, Toronto, Lima	+6	Colombo, Dhaka
-4	Caracas, Manaus	+7	Bangkok, Jakarta
-3	Buenos Aires, São Paulo	+8	Beijing, Hong Kong, Singapore
-2	Fernando de Noronha	+9	Tokyo, Seoul
-1	Azores	+10	Sydney, Guam
±0	London, Casablanca	+11	New Caledonia
		+12	Auckland, Fiji

Monitor Settings

Choose whether or not to display information in the monitor, and set the monitor brightness.

Photo info

Choose information displayed in monitor during shooting and playback mode.





Brightness

Choose from five settings for monitor brightness. The default setting is **3**.

Photo Info

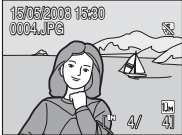
The following display options are available.

See "The Monitor" (📷 6, 7) for information on indicators in the monitor.

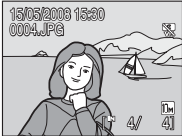
	Shooting mode	Playback mode
Show info		
Auto info (default setting)	After the same information as in Show info above is displayed for a few seconds, display will be the same as Hide info .	
Hide info		
Framing grid	 <p>In 📷 (auto) mode or high sensitivity shooting mode, a framing grid is displayed to help frame pictures; other current settings or operation guide is displayed for a few seconds, as in Auto info above.</p> <p>In other shooting modes, the current settings or operation guide is displayed, as in Auto info above.</p>	 <p>The current settings or operation guide is displayed, as in Auto info above.</p>

Date Imprint

Date and time are imprinted on pictures. Date can be printed from printers that do not support the date imprinting ( 84).

Off (default setting)

Date and time are not imprinted on pictures.

Date

Date is imprinted on the bottom right corner of pictures taken while this option is in effect.

Date and time



Date and time are imprinted on the bottom right corner of pictures taken while this option is in effect.

Date counter

Time stamp shows number of days between date of recording and selected date.

At settings other than **Off**, the icon for the current setting is displayed in the monitor ( 6).

Date Imprint

- Imprinted dates form a permanent part of image data and cannot be deleted.
- Dates imprinted at an **Image mode** setting ( 87) of **TV screen (640)** may be difficult to read. Choose **PC screen (1024)** or larger when using date imprint.
- When **Date imprint** is selected, **Electronic VR** ( 114) will be set to **Off**. After that, even if **Date imprint** is returned to **Off**, **Electronic VR** remains **Off**.
- The date is recorded using the format selected in the setup menu's **Date** item ( 16, 108).

Date Imprint and Print Set

When pictures are printed from DPOF-compatible printers that can print date and photo information, you can use **Print Set** ( 83) and print the shooting date and photo information on the pictures. In such a case, it is unnecessary to imprint date and time on pictures beforehand using **Date Imprint**.

Date Counter

Pictures taken while this option is in effect are imprinted with the number of days remaining until, or the number of days elapsed since a specified date. Use it to track the growth of a child or count down the days until a birthday or wedding.

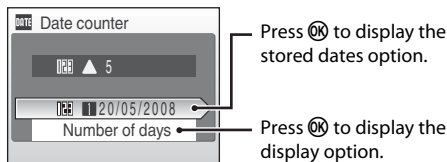

Stored dates

Up to three dates can be stored. To set, choose an option, press the multi selector **▶**, enter a **Date** (17), and press **OK**. To select a different date, choose an option and press **OK**.

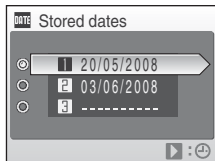

Display options

Choose **Number of days**, **Years and days**, or **Yrs, mnths, days** and press **OK**.

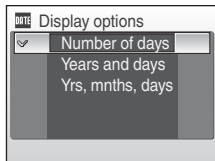

Sample date counter time stamps are shown below.



Two days remaining



Two days elapsed

Electronic VR

Specify the electronic vibration reduction setting for shooting still pictures.



Auto (default setting)

The effects of camera shake and blurred subjects are reduced while pictures are shot under the following conditions:

- Flash mode is set to **Off** or **Slow sync**
- Shutter speed is slow
- **Single** is selected for the **Continuous** setting

Off



Electronic vibration reduction is not enabled.

When  is displayed in the monitor with **Auto** specified, the camera applies vibration reduction to suit shooting conditions ( 6).



Notes on Electronic VR

- Electronic VR may not work properly immediately after the camera is turned on or reactivated from standby mode.
- Electronic VR does not work when the exposure time is faster than a certain value.
- Electronic VR is less effective for when pictures are considerably blurred.
- Blurred subjects cannot be compensated.

Electronic Vibration Reduction Icons in Playback Mode

The compensated pictures are marked with the  icon in full-frame playback mode. If electronic VR cannot compensate a blurred picture, the picture is marked with the  icon in full-frame playback mode ( 7, 50).

Compensating Movies with Electronic VR

Electronic VR can be enabled for movie recording from **Electronic VR** ( 63) in the movie menu ( 62).

AF Assist

Change settings for AF-assist illumination.

Auto (default setting)

AF-assist illumination will be used to assist the focus operation when the subject is poorly lit. Note that for some scene modes, AF-assist illumination turns off automatically.



Off

Disable this function. The camera may be unable to focus if lighting is poor.

Digital Zoom

Adjust settings for using digital zoom.

On (default setting)

Digital zoom ( 23) will be activated when the **T** () is pressed when the optical zoom has been magnified to its maximum rate.

Off

Digital Zoom will not be activated (Except when shooting a movie).

Notes on Digital Zoom

- AF area ( 94) will be set **Center** when digital zoom is been used.
- Digital zoom cannot be used in the following situations.
 - When Scene Mode is set to **Portrait** or **Night portrait**.
 - When the smile mode is selected.
 - When **Continuous** mode is set to **Multi-shot 16**.
 - Just before recording a movie (Up to 2x zoom can be activated while recording movies other than **Time-lapse movie** ★).

Sound Settings

Adjust the following sound settings.

Button sound

Turn button sound **On** or **Off**.

When **On** (default setting) is selected, a beep will sound once when operations are completed successfully, two times when focus has been locked, and three times when an error is detected, and welcome sound.

Shutter sound

Choose shutter sound from **On** (default setting) or **Off**.

Auto Off

When the camera is on and a period of time passes without any operations been done, the camera will enter standby mode ( 15) to save power. Once in standby mode, the power lamp will blink, and if no operations are performed for another three minutes the camera turns off. The time taken to enter standby mode can be set to **30 s**, **1 m** (default setting), **5 m**, or **30 m**.

Notes on Auto Off

The time allowed to elapse before the camera enters standby mode is fixed in the following cases:

- While menus are displayed: 3 minutes
- While slide show is in progress: Up to 30 minutes
- When any smiling face cannot be detected in the smile mode: 5 minutes (30 minutes: When **Auto Off** is set to **30 m**)
- While the AC adapter is connected: 30 minutes

Format Memory / **Format Card**

Use this option to format the internal memory or a memory card.

Formatting the Internal Memory

To format the internal memory, remove the memory card from the camera.

The **Format memory** option appears in the setup menu.

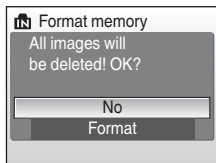

Formatting a Memory Card

When the memory card is inserted in the camera, the **Format card** option appears in the setup menu.

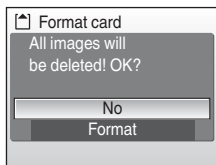

Formatting Internal Memory and Memory Cards

- Formatting the internal memory or memory cards permanently deletes all data. Be sure to transfer important pictures to a computer before formatting.
- Do not turn the camera off, disconnect the AC adapter, or open the battery-chamber/memory card slot cover during formatting.
- The first time you insert the memory cards used in other devices into the COOLPIX S550, be sure to format them using this camera.

Language

Choose one of 24 languages for display of camera menus and messages.

Čeština	Czech
Dansk	Danish
Deutsch	German
English	(default setting)
Español	Spanish
Ελληνικά	Greek
Français	French
Indonesia	Indonesian
Italiano	Italian
Magyar	Hungarian
Nederlands	Dutch
Norsk	Norwegian

Polski	Polish
Português	Portuguese
Русский	Russian
Suomi	Finnish
Svenska	Swedish
Türkçe	Turkish
عربي	Arabic
中文简体	Simplified Chinese
中文繁體	Traditional Chinese
日本語	Japanese
한국	Korean
ภาษาไทย	Thai

Video Mode

Adjust settings for connection to a television. Choose from **NTSC** and **PAL**.

Blink Warning

Set whether or not to detect human subjects with eyes closed when shooting pictures in the face priority ( 96).

On (default setting)

When the camera detects that one or more human subjects may have closed eyes shortly after recognizing the faces and shooting them, a message will appear in the monitor.

After the message was displayed, any relevant people's face (up to 12) is framed by a yellow border in view images mode. In such a case, you can check the shot picture and determine if you take the picture again.

Off

Blink warning doesn't take effect.

Operating the Blink Warning Screen

When the camera detects any human subjects with closed eyes, **One or more subjects may have closed their eyes.** message is displayed and then, the screen shown in the right will appear.

The following operations are available in the blink warning screen.

If no operations are performed for a few seconds, the screen automatically returns to the shooting mode screen.

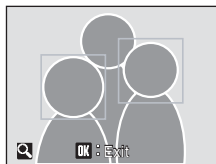





Option	Use	Description
Enlarge and display the detected face	T (Q)	Press T (Q).
Switch to full-frame playback	W (checkered flag)	Press W (checkered flag).
Select the face to be displayed		If the camera detects more than one human subjects with their eyes closed, press ►▼◀▲ during the enlarged display to switch over the face displayed.
Delete the shot picture		Press .
Switch to shooting mode		Press OK or the shutter-release button.

Reset All

When **Reset** is selected, the camera's settings will be restored to their default values.





Pop-up Menu

Option	Default value
Flash mode ( 28)	Auto
Self-timer ( 30)	Off
Macro mode ( 31)	Off
Exposure compensation ( 32)	0.0









Scene Mode

Option	Default value
Scene menu ( 34)	Portrait

Movie Menu

Option	Default value
Movie options ( 62)	TV movie 640★
Time-lapse movie★ ( 64)	30s
Electronic VR ( 63)	On
Autofocus mode ( 63)	Single AF

Shooting Menu

Option	Default value
Image mode ( 87)	 Normal (3648)
White balance ( 89)	Auto
Continuous ( 91)	Single
Intvl timer shooting ( 92)	30s
ISO sensitivity ( 93)	Auto
Color options ( 93)	Standard color
AF area mode ( 94)	Face Priority
Distortion control ( 97)	Off

Smile Menu

Option	Default value
Face recognition (F 45)	On

Setup Menu

Option	Default value
Menus (F 106)	Text
Welcome screen (F 107)	Disable welcome
Photo info (F 111)	Auto info
Brightness (F 111)	3
Date imprint (F 112)	Off
Electronic VR (F 114)	Auto
AF assist (F 115)	Auto
Digital zoom (F 115)	On
Button sound (F 116)	On
Shutter sound (F 116)	On
Auto off (F 116)	1 m
Blink warning (F 118)	On

Others

Option	Default value
Paper size (F 79, 80)	Default
Slide show (F 101)	3s

- Choosing **Reset all** also clears the current file number (F 124) from the memory. Numbering will continue from the lowest number available. To reset file numbering to "0001", delete all pictures (F 102) before selecting **Reset all**.
- The following settings in the menus will remain unaffected even if **Reset all** is performed.
 - Smile menu: the registered people in **Add to list** (F 45)
 - Shooting menu: Preset manual in the **White balance** menu (F 90)
 - Setup menu: settings for picture registered for **Welcome screen** (F 107), **Date** (F 108), **Date counter** (F 113), **Language** (F 118), and **Video mode** (F 118)

Ver. Firmware Version

View the current camera firmware version.



Firmware version

Optional Accessories

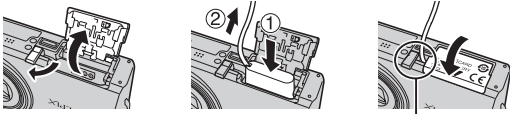
Rechargeable battery	Rechargeable Li-ion Battery EN-EL11
Battery charger	Battery Charger MH-64
AC adapter	<p>AC Adapter EH-62E</p> <p><How to attach EH-62E></p>  <p>Please check that the AC adapter cord has been inserted correctly into the battery chamber before closing the battery-chamber/memory card slot cover. If part of the cord has not been inserted into the chamber the cover may be damaged during closure.</p>
Audio Video/USB Cable	Audio Video/USB Cable UC-E12

Approved Memory Cards

The following memory cards have been tested and approved for use in the COOLPIX S550.

All cards of the designated make and capacity can be used, regardless of speed.

SanDisk	128 MB, 256 MB, 512 MB, 1 GB, 2 GB ¹ , 4 GB ²
Toshiba	128 MB, 256 MB, 512 MB, 1 GB, 2 GB ¹ , 4 GB ²
Panasonic	128 MB, 256 MB, 512 MB, 1 GB, 2 GB ¹ , 4 GB ²

¹ If the memory card will be used with a card reader or similar device, check that device supports 2 GB cards.

²  SDHC compliant. If the memory card will be used with a card reader or similar device, check that device supports SDHC.





Operation is not guaranteed with other makes of card. Contact the manufacturer for details on the above cards.

Image/Sound File

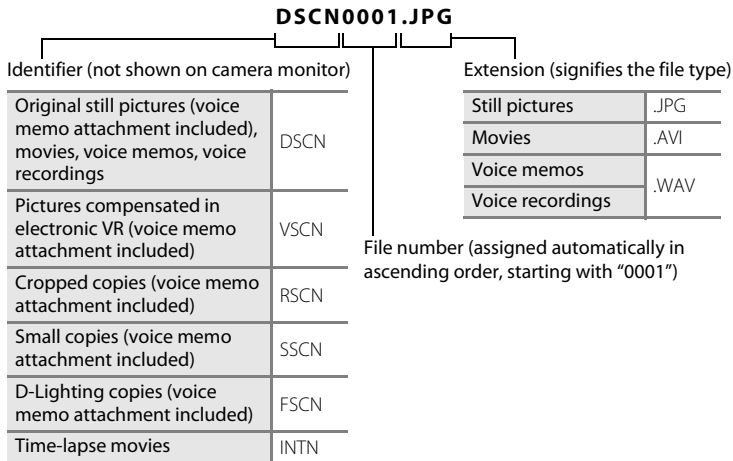
Image/Sound File and Folder Names











Pictures, movies, voice memos and voice recordings are assigned file names as follows.



- Files are stored in folders named with a folder number followed by a five-character identifier: "P_" plus a three-digit sequence number for pictures taken using panorama assist (e.g. "101P_001";  41), "INTVL" for interval timer photography (e.g. "101INTVL";  92), "SOUND" for voice recordings (e.g. "101SOUND";  67), and "NIKON" for all other pictures (e.g. "100NIKON"). When the number of files within a folder reaches 9999, a new folder will be created. File numbers will be assigned automatically starting with "0001."
- Files copied using **Copy > Selected images** or **Copy sound files > Selected files** are copied to the current folder, where they are assigned new file numbers in ascending order starting from the largest file number in memory. **Copy > All images** and **Copy sound files > Copy all files** copy all folders from the source medium; file names do not change but new folder numbers are assigned in ascending order, starting from the largest folder number on the destination medium ( 71, 104).
- Folders can hold up to 200 pictures; if a picture is taken when the current folder contains 200 pictures, a new folder will be created by adding one to the current folder number. If a picture is taken when the current folder is numbered 999 and contains 200 pictures or a picture numbered 9999, no further pictures can be taken until the medium is formatted ( 117) or a new memory card inserted.

Cropped Image Size

Depending on the size of the original picture and the zoom ratio in effect at the time the copy was created, the camera will automatically select one of the following image-mode settings for cropped copies (unit: pixels) (51).

-  3,648 × 2,736
-  2,592 × 1,944
-  2,272 × 1,704
-  2,048 × 1,536
-  1,600 × 1,200
-  1,280 × 960
-  1,024 × 768
-  640 × 480
-  320 × 240
-  160 × 120

Caring for the Camera

To ensure continued enjoyment of this Nikon product, observe the following precautions when using or storing the device:

Keep dry

The device will be damaged if immersed in water or subjected to high humidity.

Do not drop

The product may malfunction if subjected to strong shock or vibration.

Handle the lens and all moving parts with care

Do not apply force to the lens, lens cover, monitor, memory card slot or battery chamber. These parts are easily damaged. Applying force to the lens cover could result in camera malfunction or damage to the lens. Should the monitor break, care should be taken to avoid injury caused by broken glass and to prevent the liquid crystal from the display touching the skin or entering the eyes or mouth.

Do not point the lens at strong light sources for extended periods

Avoid pointing the lens at the sun or other strong light sources for extended periods when using or storing the camera. Intense light may cause deterioration of the CCD image sensor, producing a white blur effect in photographs.

Keep away from strong magnetic fields

Do not use or store this device in the vicinity of equipment that generates strong electromagnetic radiation or magnetic fields. Strong static charges or the magnetic fields produced by equipment such as radio transmitters could interfere with the monitor, damage data stored on the memory card, or affect the product's internal circuitry.

Avoid sudden changes in temperature

Sudden changes in temperature, such as when entering or leaving a heated building on a cold day, can cause condensation to form inside the device. To prevent condensation, place the device in a carrying case or a plastic bag before exposing it to sudden changes in temperature.

Turn the product off before removing or disconnecting the power source

Do not remove the battery while the product is on, or while images are being recorded or deleted. Forcibly cutting power in these circumstances could result in loss of data or in damage to product memory or internal circuitry.

The Self-timer Lamp/AF-assist Illuminator LED

The light-emitting diode (LED;  4, 30, 115) used in the self-timer lamp/AF-assist illuminator conforms to the following IEC standard:

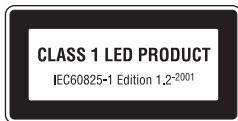

The Battery

- Check the battery level when taking the camera out, and charge the battery if necessary. Do not continue charging once the battery is fully charged, as this will result in reduced battery performance. If possible, carry a fully-charged spare battery when taking pictures on important occasions.
- Do not use the battery at ambient temperatures below 0 °C (32 °F) or above 40 °C (104 °F). Failure to observe this precaution could damage the battery or impair its performance.
- When recharging, the ambient temperature should be in the vicinity of 5 to 35 °C (41 to 95 °F).
- The battery will not charge if its temperature is below 0 °C (32 °F) or above 60 °C (140 °F). Charging times may increase at battery temperatures from 0 °C to 10 °C (32 °F to 50 °F) and from 45 °C to 60 °C (113 °F to 140 °F).
- On cold days, the capacity of batteries tends to decrease. Be sure that the battery is fully charged before heading outside to take pictures in cold weather. Keep spare batteries in a warm place and exchange as necessary. Once warmed, a cold battery may recover some of its charge.
- Should the battery terminals become dirty, wipe them off with a clean, dry cloth before use.
- If the battery will not be used for some time, insert it in the camera and run it flat before removing it for storage. The battery should be stored in a cool location with an ambient temperature of 15 to 25 °C (59 to 77 °F). Do not store the battery in hot or extremely cold locations.
- While the battery is in storage, charge it at least once every six months and then use the camera to run it flat again before storing it in a cool location.
- Always remove the battery from the camera or battery charger when it is not being used. Left installed, minute amounts of current flow even when unused, and the battery may become excessively drained and no longer function.
- After removing the battery from the camera or battery charger, place it in the supplied battery case and store in a cool place.
- A marked drop in the time a fully-charged battery retains its charge, when used at room temperature, indicates that the battery needs to be replaced. Purchase a new EN-EL11 battery.
- Replace the battery when it no longer holds a charge. Used batteries are a valuable resource. Please recycle used batteries in accordance with local regulations.

Cleaning

Lens	Avoid touching glass parts with your fingers. Remove dust or lint with a blower (typically a small device with a rubber bulb attached to one end that is pumped to produce a stream of air out the other end). To remove fingerprints or other stains that cannot be removed with a blower, wipe the lens with a soft cloth, using a spiral motion that starts at the center of the lens and working toward the edges. If this fails, clean the lens using a cloth lightly dampened with commercial lens cleaner.
Monitor	Remove dust or lint with a blower. To remove fingerprints and other stains, clean the monitor with a soft, dry cloth, being careful not to apply pressure.
Body	Use a blower to remove dust, dirt or sand, then wipe gently with a soft, dry cloth. After using the camera at the beach or seaside, wipe off any sand or salt with a dry cloth lightly dampened with fresh water, then dry thoroughly. Note that foreign matter inside the camera could cause damage not covered by the warranty.

Do not use alcohol, thinner, or other volatile chemicals.

Storage

Turn the camera off when not in use. Check that the power-on lamp is off before putting the camera away. Remove the battery if the camera will not be used for an extended period. Do not store the camera with naphtha or camphor moth balls, or in any of the following locations:

- Next to equipment that produces strong electromagnetic fields, such as televisions or radios
- Exposed to temperatures below -10°C (14°F) or above 50°C (122°F)
- Poorly ventilated or subject to humidities of over 60 %

To prevent mold or mildew, take the camera out of storage at least once a month. Turn the camera on and release the shutter a few times before putting the camera away again.





















Notes on the Monitor

- The monitor may contain a few pixels that are always lit or that do not light. This is a characteristic common to all TFT LCD displays, and does not indicate a malfunction. Images recorded using the product will not be affected.
- When framing bright subjects, vertical comet-like streaks that whiten toward either end may appear in the display. This phenomenon, known as “smear,” does not appear in the final photograph and does not indicate a malfunction. Some smear may appear in movies.
- Images in the monitor may be difficult to see under bright lighting.
- The monitor is lit by an LED backlight. Should the monitor begin to dim or flicker, contact your Nikon-authorized service representative.











Error Messages















The following table lists the error messages and other warnings displayed in the monitor, as well as the solutions for dealing with them.

Display	Problem	Solution	
 (blinks)	Clock not set.	Set clock.	108
	Battery running low.	Prepare to charge or change battery.	12
 Battery exhausted.	Battery exhausted.	Charge or change battery.	12
 Battery temperature high	Battery temperature is high.	Turn off camera, and allow battery to cool down before resuming use. After 5 seconds, this message will disappear, the monitor will turn off, and the power-on lamp and flash lamp will blink rapidly. After the lamps blink for 30 seconds, the camera will turn off automatically, but you can also press the power switch to turn it off manually.	15
 ● (● blinks red)	Camera cannot focus.	<ul style="list-style-type: none"> • Refocus. • Use focus lock. 	24, 25 95
 Please wait for the camera to finish recording. 	Camera cannot perform other operations until recording is complete.	Wait until message clears from display automatically when recording is complete.	25
 Memory card is write protected.	Write-protect switch is in "lock" position.	Slide write-protect switch to "write" position.	19
 This card cannot be used.	Error accessing memory card.	<ul style="list-style-type: none"> • Use approved card. • Check that connectors are clean. • Confirm that memory card is correctly inserted. 	123 18
 This card cannot be read.			18

Display	Problem	Solution	
 Card is not formatted. Format card? No Yes	Memory card has not been formatted for use in COOLPIX S550.	Choose Yes and press  to format card, or turn camera off and replace card.	19
 Out of memory.	Memory card is full.	<ul style="list-style-type: none"> • Choose smaller image size. • Delete pictures or sound files. • Insert new memory card. • Remove memory card and use internal memory. 	87 26, 66, 70 18 19
 Image cannot be saved.	Error occurred while recording picture.	Format internal memory or memory card.	117
	Camera has run out of file numbers.	<ul style="list-style-type: none"> • Insert new memory card. • Format internal memory or memory card. 	18 117
	Picture cannot be used for welcome screen.	Pictures which are set as 16:9 (1920) on Image mode setting and images smaller than 320 × 240 edited by the crop or small picture function are not selectable.	51, 52, 87
	Cannot copy picture.	Delete pictures from destination.	102
 Sound file cannot be saved.	Camera has run out of file numbers.	<ul style="list-style-type: none"> • Insert new memory card. • Format internal memory or memory card. 	18 117
 Image cannot be modified.	Cannot edit selected picture.	Select picture that supports D-Lighting, Electronic VR, crop or small picture.	48
 Cannot record movie.	Time out error while recording movie.	Choose memory card with faster write speed.	123

Error Messages

Display	Problem	Solution	
 Memory contains no images.	<ul style="list-style-type: none"> No pictures or sound file in the internal memory or memory card. 	–	–
 No sound file.	<ul style="list-style-type: none"> Memory card does not contain pictures or sound file. 	To copy picture or sound file from internal memory to memory card, press MENU . The copy option screen or copy sound file screen will be displayed.	104, 71
 File contains no image data.	File not created with COOLPIX S550.	View file on computer or other device.	–
 This file cannot be played back.			
 All images are hidden.	Date and time are not set for pictures to be displayed in calendar mode or list by date mode.	–	–
 This image cannot be deleted.	Picture is protected.	Disable protection.	102
 Travel destination is in the current time zone.	Destination in same time zone as home.	–	108
Lens error 	Lens error.	Turn camera off and then on again. If error persists, contact retailer or Nikon-authorized service representative.	20
 Communications error	Audio video/USB cable disconnected during printing.	Turn camera off, reconnect audio video/USB cable.	78
System error 	Error has occurred in camera's internal circuitry.	Turn camera off, remove and reinsert battery, and turn camera on. If error persists, contact retailer or Nikon-authorized service representative.	14, 20



Display	Problem	Solution	
 Printer error: check printer status.	Running out of ink or printer error.	Check printer. After checking the ink or solving the problem, select Resume and press  to resume printing.*	-
 Printer error: check paper	Specified size of paper is not loaded in printer.	Load the specified paper, select Resume and press  to resume printing.*	-
 Printer error: paper jam	Paper has jammed in the printer.	Eject the jammed paper, select Resume and press  to resume printing.*	-
 Printer error: out of paper	No paper is loaded in printer.	Load the specified paper, select Resume and press  to resume printing.*	-
 Printer error: check ink	Ink error.	Check ink, select Resume and press  to resume printing.*	-
 Printer error: out of ink	Ink cartridge is empty.	Replace ink, select Resume and press  to resume printing.*	-
 Printer error: file corrupt	An error caused by the image file has occurred.	Select Cancel and press  to cancel printing.	-

* See the documentation provided with your printer for further guidance and information.

Troubleshooting

If the camera fails to function as expected, check the list of common problems below before consulting your retailer or Nikon-authorized service representative. Refer to the page numbers in the right-most column for more information.

Display, Settings and Power Supply





Problem	Cause/Solution	
Monitor is blank	<ul style="list-style-type: none"> • Camera is off. • Battery is exhausted. • Standby mode for saving power: press the shutter-release button halfway. • When flash lamp blinks red, wait until flash has charged. • Camera and computer are connected via Audio/Video/USB cable. • Camera and TV are connected via Audio/Video/USB cable. • Time lapse or interval timer photography in progress. 	20 20 15, 24 29 74 72 –
Monitor is hard to read	<ul style="list-style-type: none"> • Adjust monitor brightness. • Monitor is dirty. Clean monitor. • Monitor has dimmed to save power. Monitor brightens when controls are used. 	111 128 15
Camera turns off without warning	<ul style="list-style-type: none"> • Battery is low. • Camera has turned off automatically to save power. • Battery is cold. 	20 116 127
Date and time of recording are not correct	<ul style="list-style-type: none"> • Pictures recorded before clock was set, and “Date not set” indicator blinks during shooting, will have time stamp of “00/00/0000 00:00”; movies and voice recordings will be dated “01/03/2008 00:00.” • Check camera clock regularly against more accurate timepieces and reset as required. 	16 108
No indicators displayed in monitor	Hide info is selected for Photo info . Select Show info .	111
Date imprint not available	Camera clock has not been set.	16, 108
Date not appearing on pictures even when Date imprint is enabled	Date does not appear on movies or on pictures taken using  ,  or when Continuous is set to Continuous or BSS .	36, 39, 40, 61, 91









Problem	Cause/Solution	
Electronic VR will automatically be set to OFF	Electronic VR and Date imprint cannot be used at the same time. When Date imprint is selected, Electronic VR will automatically be set to Off . Reset Electronic VR to Auto .	114
Camera settings reset	Backup battery is exhausted; all settings were restored to their default values.	109
Monitor turns off, and the power-on lamp and flash lamp blink rapidly.	Battery temperature is high. Turn off camera, and allow battery to cool down before resuming use. After the lamps blink for 30 seconds, the camera will turn off automatically, but you can also press the power switch to turn it off manually.	15

Electronically Controlled Cameras

In extremely rare instances, unusual characters may appear in the monitor and the camera may stop functioning. In most cases, this phenomenon is caused by a strong external static charge. Turn the camera off, remove and replace the battery, then turn the camera on again. In the event of continued malfunction, contact your retailer or Nikon-authorized service representative. Note that disconnecting the power source as described above may result in the loss of any data not recorded to internal memory or the memory card at the time the problem occurred. Data already recorded will not be affected.

Shooting

Problem	Cause/Solution	
No picture taken when shutter-release button is pressed.	<ul style="list-style-type: none"> • When camera is in playback mode, press  or the shutter-release button. • When menus are displayed, press MENU. • Battery is exhausted. • When flash lamp blinks, flash is charging. 	<p>26</p> <p>10</p> <p>20</p> <p>29</p>
Camera cannot focus.	<ul style="list-style-type: none"> • The intended subject is one with which autofocus does not perform well. • Set AF assist in the setup menu to Auto. • Focus error. Turn camera off and then on again. 	<p>25</p> <p>115</p> <p>20</p>
Pictures are blurred.	<ul style="list-style-type: none"> • Use flash. • Use high sensitivity shooting mode. • Use Electronic VR. • Use BSS (Best Shot Selector). • Use tripod and self-timer. 	<p>28</p> <p>33</p> <p>114</p> <p>91</p> <p>30</p>
Bright specks appear in pictures taken with flash.	Flash is reflecting off particles in air. Turn flash off.	29
Flash does not fire.	<ul style="list-style-type: none"> • Flash is off. • Some scene modes that cannot turn on flash are selected. •  modes other than Time-lapse movie  is selected. • Continuous, Multi-shot 16 or BSS is selected for Continuous. 	<p>28</p> <p>34</p> <p>61</p> <p>91</p>
Optical zoom cannot be used.	Optical zoom cannot be used while recording movies.	61
Digital zoom cannot be used.	<p>Digital zoom is set to Off in the setup menu. Digital zoom is not available in the following situations.</p> <ul style="list-style-type: none"> • when Portrait or Night portrait is selected for Scene mode. • when the smile mode is selected. • just before recording a movie (up to 2x can be applied while recording movies other than Time-lapse movie ) • when Multi-shot 16 is selected for Continuous. 	<p>115</p> <p>35, 36</p> <p>43</p> <p>61</p> <p>91</p>

Problem	Cause/Solution	
Image mode not available.	Image mode cannot be adjusted when Multi-shot 16 is selected for Continuous .	91
No sound when shutter is released.	<ul style="list-style-type: none"> • Off is selected for Sound settings > Shutter sound in setup menu. • Continuous or Multi-shot 16 or BSS is selected for Continuous in shooting menu. •  (Sports scene mode) or  (Museum scene mode) is selected. •  mode is selected. • Do not block the speaker. 	116 91 36, 39 61 5
AF-assist illuminator does not light.	<ul style="list-style-type: none"> • Off is selected for AF assist option in camera setup menu. • AF-assist illuminator turns off automatically in some modes. 	115 35-40
Pictures appear smeared.	Lens is dirty. Clean lens.	128
Colors are unnatural.	White balance does not match light source.	89
Randomly spaced bright pixels ("noise") appear in image.	Shutter speed too slow. Noise can be reduced by: <ul style="list-style-type: none"> • Using flash • Specifying a lower ISO sensitivity setting • Using a scene mode which has noise reduction ability. 	28 93 35-40
Pictures are too dark (underexposed).	<ul style="list-style-type: none"> • Flash is off. • Flash window is blocked. • Subject is beyond flash range. • Adjust exposure compensation. • Apply high sensitivity shooting mode, or raise the ISO sensitivity. • Subject is backlit. Select  (Back light scene mode) or use fill flash. 	28 22 28 32 33, 93 28, 40
Pictures are too bright (overexposed).	Adjust exposure compensation.	32
Unexpected results when flash set to  (auto with red-eye reduction).	If taking pictures with  (auto with red-eye reduction) or fill flash with slow sync and red-eye reduction when scene mode is set to Night portrait , In-Camera Red Eye Fix may be applied to areas not affected by red-eye. Use any other scene mode other than Night portrait , and change the flash to any other settings other than  (auto with red-eye reduction) and try shooting again.	28, 36

Playback

Problem	Cause/Solution	
File cannot be played back.	<ul style="list-style-type: none"> • File was overwritten or renamed by computer or other make of camera. • Time-lapse or interval timer photography in progress: pictures cannot be played back until recording is complete. 	– 64, 92
Cannot zoom in on picture.	Playback zoom cannot be used with movies, small pictures, or pictures that have been cropped to below 320 × 240.	–
Cannot record voice memo.	<ul style="list-style-type: none"> • Voice memos cannot be appended to movies. • Voice memos cannot be attached to images taken with other cameras. Voice memos that are attached to the image using other cameras cannot be played back on this camera. 	66 54
Cannot use D-Lighting, Electronic VR, crop, or small picture options.	<ul style="list-style-type: none"> • These options cannot be used with movies. • These options except Electronic VR cannot be used with pictures taken when 16:9 (1920) is applied in the Image mode setting. • Select picture that supports D-Lighting, Electronic VR, crop, or small picture. • Camera is unable to edit pictures taken with other cameras. • Other cameras may be unable to play back pictures recorded with this camera. 	66 87 48 48 48
Pictures not displayed on television.	<ul style="list-style-type: none"> • Choose correct Video mode. • Memory card contains no pictures. Replace memory card. Remove memory card to play back pictures from internal memory. 	118 18
Nikon Transfer does not start when camera is connected.	<ul style="list-style-type: none"> • Camera is off. • Battery is exhausted. • Audio/Video/USB cable is not correctly connected. • If the computer OS used is Windows 2000 Professional, the camera will not be able to connect. • Camera is not recognized by the computer. • Computer is not set to launch Nikon Transfer automatically. 	20 20 74 75 – –

Problem	Cause/Solution	
Pictures to be printed are not displayed.	Memory card contains no pictures. Replace memory card. Remove memory card to print pictures from internal memory.	18
Cannot select paper size with camera.	Paper size cannot be selected from the camera if the printer does not support the paper sizes used by the camera, or the printer automatically selects the paper size. Use the printer to select paper size.	79, 80

Specifications

Nikon COOLPIX S550 Digital Camera

Type	Compact digital camera
Effective pixels	10 million
Image sensor	¹ /2.3-in. CCD; total pixels: 10.34 million
Lens	5x Zoom-Nikkor lens
Focal length	6.3-31.5mm (equivalent with 35mm [135] format picture angle: 36-180mm)
f/-number	f/3.5-5.6
Construction	8 elements in 6 groups
Digital zoom	Up to 4x (equivalent with 35mm [135] format picture angle: approx. 720mm)
Vibration reduction	Electronic VR
Autofocus (AF)	Contrast-detect AF
Focus range (from lens)	<ul style="list-style-type: none">• Approx. 35 cm (1 ft. 2 in.) to ∞ (W); approx. 60 cm (2 ft.) to ∞ (T)• Macro mode: 10 cm (3.9 in.) (wide-angle zoom position) to ∞
Focus-area selection	Auto (9-area automatic selection), center, manual with 99 focus areas, face priority
AF-assist illumination	Class 1 LED product (IEC 60825-1 Edition 1.2- ²⁰⁰¹); max. output: 610 μW
Monitor	Wide vision 2.5 in., Approx. 230k-dot, TFT LCD with anti-reflection coating and 5-level brightness adjustment
Frame coverage (shooting mode)	Approx. 97 % horizontal and 97 % vertical (Compared to actual picture)
Frame coverage (playback mode)	Approx. 100 % horizontal and 100 % vertical (Compared to actual picture)
Storage	
Media	<ul style="list-style-type: none">• Internal memory (approx. 50 MB)• SD (Secure Digital) memory cards
File system	DCF, Exif 2.2, and DPOF compliant
File formats	Compressed: JPEG-Baseline compliant Movies: AVI Sound files: WAV
Image size (pixels)	<ul style="list-style-type: none">• 3,648 × 2,736 [High (3648★)/Normal (3648)]• 2,592 × 1,944 [Normal (2592)]• 2,048 × 1,536 [Normal (2048)]• 1,024 × 768 [PC screen (1024)]• 640 × 480 [TV screen (640)]• 1,920 × 1,080 [16:9 (1920)]

ISO sensitivity (Standard output sensitivity)	ISO 64, 100, 200, 400, 800, 1600, 2000, Auto (auto gain from ISO 64 to 800)
Exposure	
Metering	256-segment matrix, center-weighted (digital zoom less than 2x), spot (digital zoom 2x or more)
Exposure control	Programmed auto exposure with exposure compensation (-2.0 to +2.0 EV in steps of $\frac{1}{3}$ EV)
Range (ISO 100)	[W]: 3.7 to 15.5 EV [T]: 5.0 to 16.8 EV
Shutter	Mechanical and charge-coupled electronic shutter
Speed	$\frac{1}{2000}$ -2 s, 4 s (Fireworks show scene mode)
Aperture	Electronically-controlled preset aperture
Range	2 steps (f/3.5 and f/5.6 [W])
Self-timer	Can be selected from 10 and 2 second duration
Built-in flash	
Range (approx.) (High sensitivity mode)	[W]: 0.3 to 4.7 m (1 to 15 ft.) [T]: 0.6 to 3.1 m (2 to 10 ft.)
Flash control	TTL auto flash with monitor preflashes
Interface	USB
Video output	Can be selected from NTSC and PAL
I/O terminal	Multi connector
Supported languages	Arabic, Chinese (Simplified and Traditional), Czech, Danish, Dutch, English, Finnish, French, Greek, German, Hungarian, Indonesian, Italian, Japanese, Korean, Polish, Portuguese, Norwegian, Russian, Spanish, Swedish, Thai, Turkish
Power sources	One EN-EL11 Rechargeable Li-ion Battery (supplied) AC Adapter EH-62E (sold separately)
Battery life*	Approx. 200 shots (EN-EL11)
Dimensions (W × H × D)	Approx. 90 × 53.5 × 22 mm (3.5 × 2.1 × 0.9 in.) (excluding projections)
Weight	Approx. 120 g (4.2 oz) (without battery and SD memory card)
Operating environment	
Temperature	0 to 40 °C (32 to 104 °F)
Humidity	Less than 85 % (no condensation)

Specifications

- * Based on Camera and Imaging Products Association (CIPA) standards for measuring the life of camera batteries. Measured at 23 °C (73 °F); zoom adjusted with each shot, flash fired with every other shot, image mode set to  **Normal (3648)**. Battery life may vary depending on shooting interval and length of time menus and images are displayed.
- * Unless otherwise stated, all figures are for a camera with a fully-charged Rechargeable Li-ion Battery EN-EL11 operated at an ambient temperature of 25 °C (77 °F).

Rechargeable Li-ion Battery EN-EL11

Type	Rechargeable lithium-ion battery
Rated capacity	DC 3.7 V, 680 mAh
Operating temperature	0 to 40 °C (32 to 104 °F)
Dimensions (W × H × D)	Approx. 27.1 × 38.2 × 7.8 mm (1.1 × 1.5 × 0.3 in.) (excluding projections)
Weight	Approx. 14.5 g (0.5 oz) (excluding battery case)

Battery Charger MH-64

Rated input	AC 100 to 240 V, 50/60 Hz, 0.06 to 0.042 A
Rated output	DC 4.2 V, 0.455 A
Applicable batteries	Nikon EN-EL11 Rechargeable Li-ion Battery
Charging time	Approx. 120 minutes when no charge remains
Operating temperature	0 to 40 °C (32 to 104 °F)
Dimensions (W × H × D)	Approx. 54 × 21 × 85 mm (2.1 × 0.8 × 3.3 in.)
Length of cord	Approx. 2 m (6 ft. 7 in.)
Weight	Approx. 56 g (2.0 oz), excluding power cable

Specifications

Nikon will not be held liable for any errors this manual may contain. The appearance of this product and its specifications are subject to change without notice.

Supported Standards

- **DCF:** Design Rule for Camera File System is a standard widely used in the digital camera industry to ensure compatibility among different makes of camera.
- **DPOF:** Digital Print Order Format is an industry-wide standard that allows pictures to be printed from print orders stored on the memory card.
- **Exif version 2.2:** This camera supports Exif (Exchangeable Image File Format for Digital Still Cameras) version 2.2, a standard that allows information stored with photographs to be used for optimal color reproduction when images are output from Exif-compliant printers.
- **PictBridge:** A standard developed cooperatively by the digital camera and printer industries, allowing photographs to be output directly to a printer without connecting the camera to a computer.

Symbols

42

W button 5, 22, 27, 46, 47, 55, 57, 59

button 5, 22, 27, 46, 47, 55, 57, 59

T button 5, 11, 22, 27, 46, 47, 55, 57, 59

button 5, 22, 27, 46, 47, 55, 57, 59

button 5, 11

Apply selection button 5, 9

Sound file playback mode 69

Auto mode 20

Calender mode 55

Delete button 5, 26, 27, 54, 66, 70

D-Lighting 49

Exposure compensation 32

Flash mode 28

High sensitivity mode 33

List by date mode 56

Macro mode 31

MENU button 5, 10

MODE Mode button 5, 8

Movie mode 61

Playback mode 8, 26

Scene mode 34

Self-timer 30

Setup mode 105

Shooting/playback button 5, 8, 26

Smile mode 43

Voice recording mode 67

A

AC adapter 123

AF area mode 94

AF-assist illumination 4, 25, 115

Audio Video/USB Cable 72, 73, 74, 78

Audio-in/Video-in jack 72

Auto flash 28

Auto mode 20

Auto off 116

Autofocus 31, 63

Autofocus mode 63

AVI 124

B

Back light 40

Battery 12, 14, 109

Battery charger 12, 123

Battery latch 5, 14

Battery level 20

Battery-chamber 5

Battery-chamber/memory card slot cover
5, 14, 18

Beach/snow 37

Best Shot Selector 91

Black-and-white 93

Blink warning 118

Brightness 111

BSS 91

Built-in flash 4, 28

Built-in microphone 4

Button sound 116

C

Calender mode 55

Close-up 38

Cloudy 89

Color options 93

Compression ratio 87

Computer 73

Continuous 91

Copy 39

Copying pictures 104

Copying voice recordings 71

Crop 51

Cyanotype 93

D

Date 16, 108

Date counter 112, 113

Date imprint 112

Daylight 89
Daylight saving time 16, 109
Delete 102
Digital zoom 23, 115
Direct print 77
Distortion control 97
D-Lighting 48, 49
DPOF 143
DPOF print 82
DSCN 124
Dusk/dawn  37

E

Electronic VR 21, 50, 63, 114
EN-EL11 12, 14
Exposure compensation 32
Extension 124
Eyelet for camera strap 4

E

Face priority 94, 96
File names 124
Fill flash 28
Fireworks show  39
Firmware version 122
Flash 28, 29
Flash lamp 5, 29
Flash off 28
Fluorescent 89
Focus 11, 24, 63, 94
Focus area 94
Focus lock 95
Folder name 124
Format 19, 117
Format memory card 19, 117
Formatting internal memory 117
FSCN 124
Full-time AF 63

H

Halfway 11
High sensitivity mode 33

I

Identifier 124
Image mode 21, 34, 87
Image size 87
Incandescent 89
Indicator lamp 5
Internal memory 17
INTN 124
Intvl timer Shooting 92
ISO sensitivity 29, 33, 93

J

JPG 124

L

Language 118
Lens 4, 140
Li-ion rechargeable battery 12, 14
List by date mode 56

M

Macro mode 31
Making voice recordings 67
Memory capacity 20, 88
Memory card 18, 123
Memory card slot 5, 18
Menus 106
Monitor 5, 6, 128
Monitor settings 111
Movie menu 62
Movie mode 61
Movie playback 66
Movie settings 62
Multi connector 5, 72, 74, 78
Multi selector 5, 9

Index

Multi-shot 16 91

Museum  39

N

Night landscape  38

Night Portrait  36

Noise reduction 36, 37, 38

Number of Exposures Remaining 20, 88

O

Optical zoom 22

Optional Accessories 123

P

Panorama assist  40, 41

Paper size 79, 80

Party/indoor  36

Photo info 111

PictBridge 77, 143

Playback 26, 27, 46, 47

Playback menu 99

Playback zoom 47

Playback-mode Selection menu 8

Playing voice recordings 69

Power 16, 20

Power switch 4, 20

Power-on lamp 4, 20

Preset manual 90

Print 79, 80, 83

Print Set 83

Print Set (Date) 84

Printer 77

Protect 102

R

Rechargeable battery 123

Rechargeable Li-ion battery 12, 14

Recording movies 61

Red-eye reduction 28, 29

Replay mode 26, 27

Reset all 120

Rotate image 103

RSCN 124

S

Scene mode 34, 35

Self-timer 30

Self-timer lamp 4, 30

Sepia 93

Setup menu 105

Shooting 20, 22, 24

Shooting menu 85

Shooting-mode Selection menu 8

Shutter sound 116

Shutter-release button 4, 24

Single 91

Single AF 63

Slide show 101

Slow Sync 28

Small picture 52

Smile indicator 35

Smile menu 45, 59

Smile mode 43, 60

Sound file playback mode 69

Sound settings 116

Speaker 5

Sports  36

SSCN 124

Standard color 93

Strap 11

Sunset  37

T

Thumbnail Playback 46

Time zone 16, 108, 110

Time-lapse movies 64

Tripod socket 5

TV 72

TV movie 62

V

Video Mode 72, 118

Vivid color 93

Voice memo 53

Volume 66, 70

VSCN 124

W

WAV 124

Welcome screen 107

White balance 89

Z

Zoom 22

Zoom button 5, 22, 66, 70



A series of horizontal dashed lines spanning the width of the page, intended for handwriting practice.



A series of horizontal dashed lines spanning the width of the page, intended for handwriting practice.



A series of horizontal dashed lines for handwriting practice, spanning the width of the page.

Nikon

No reproduction in any form of this manual, in whole or in part (except for brief quotation in critical articles or reviews), may be made without written authorization from NIKON CORPORATION.



NIKON CORPORATION

Fuji Bldg., 2-3 Marunouchi 3-chome,
Chiyoda-ku, Tokyo 100-8331, Japan

Printed in Japan
CT8A01(11)
6MMA3711-01