

Nikon Speedlight

SB-16

INSTRUCTION MANUAL

NOMENCLATURE

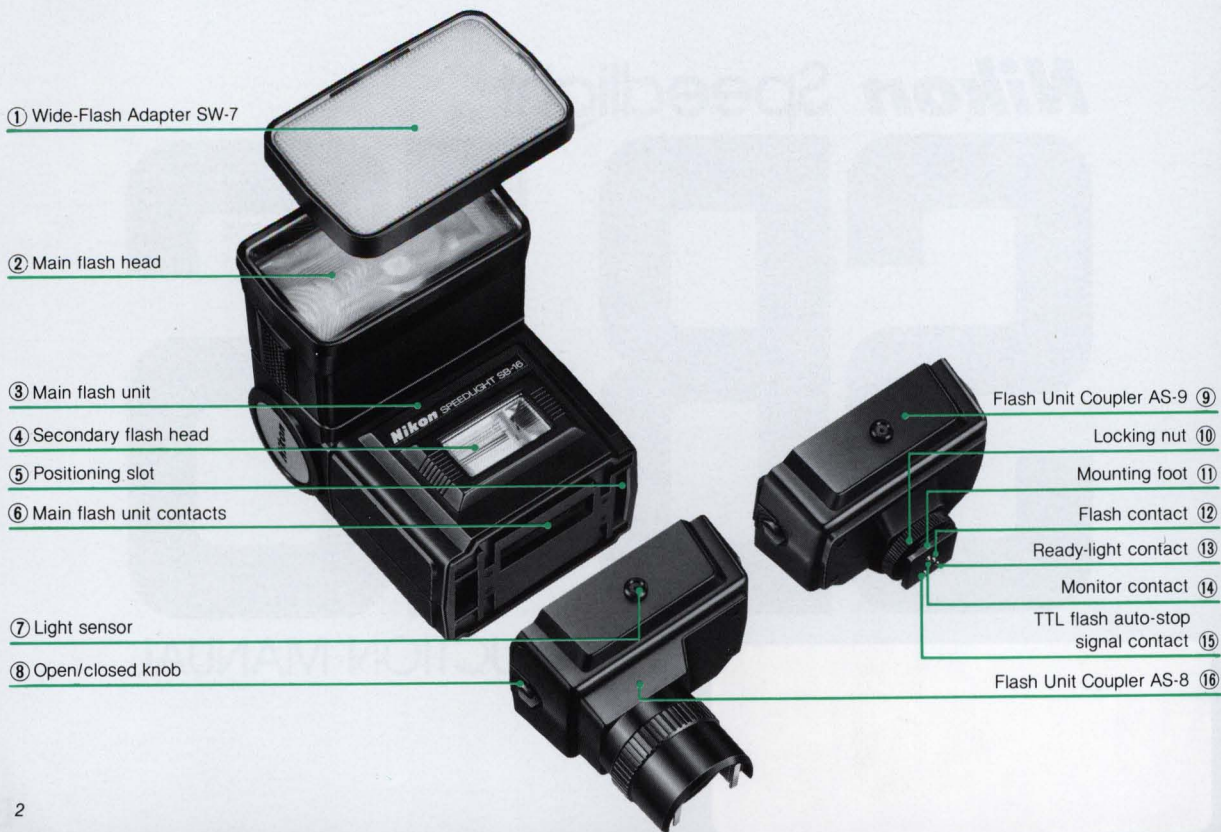

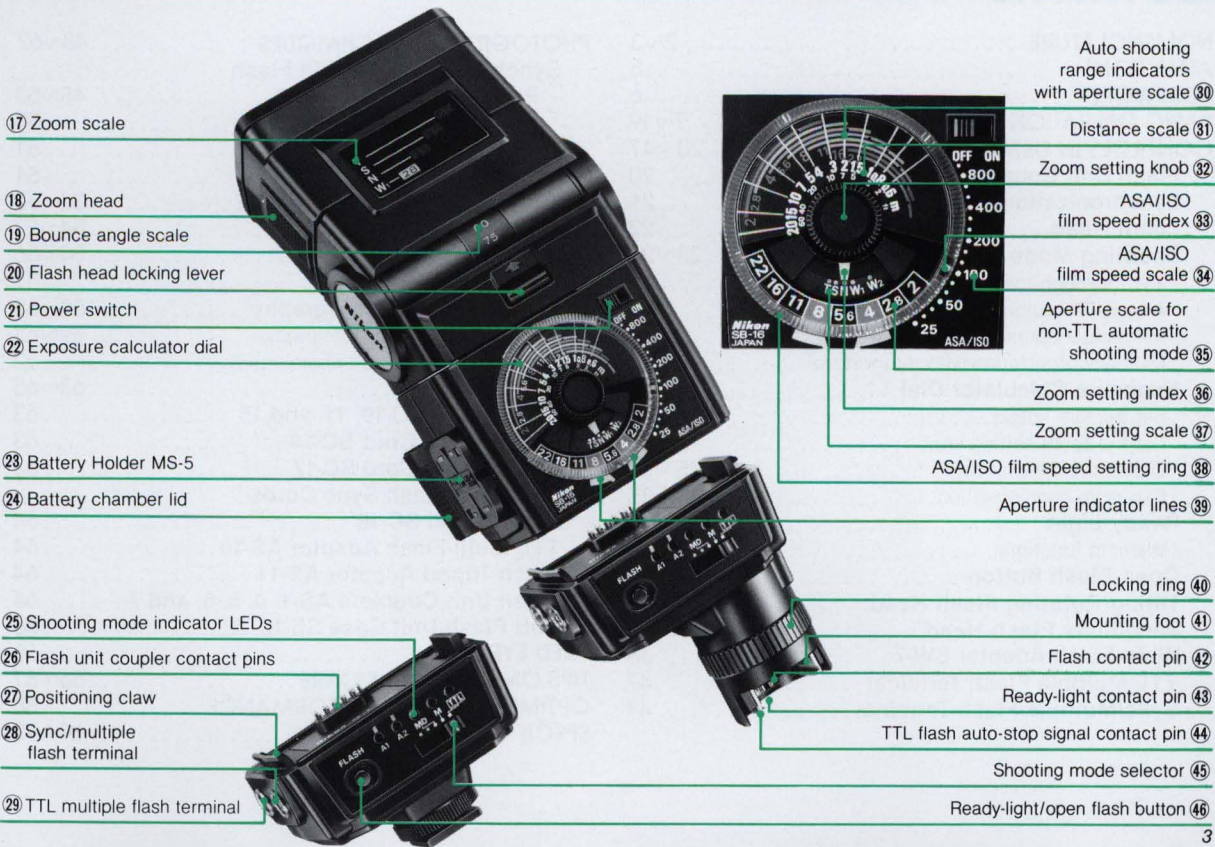

CONTENTS

NOMENCLATURE	2~3
ATTENTION!	5
FOREWORD	6
BASIC OPERATION	7~19
CONTROLS IN DETAIL	20~47
Flash Unit Couplers AS-8 and AS-9	20
Synchronization Speed	21
Zoom Head	22
Shooting Mode Selector	23~24
TTL (through-the-lens automatic operation)	23
A (non-TTL automatic operation)	23
M (manual operation)	23
MD (synchronization with motor drive)	24
Exposure Calculator Dial	24~35
Set the film speed	24
Set the zoom setting knob	25
Determine the exposure	25~32
Exposure compensation	33~35
Ready-Light	36~41
Warning functions	37~41
Open-Flash Button	42~43
Tilting/Rotating Flash Head	44
Secondary Flash Head	45
Wide-Flash Adapter SW-7	46
TTL Multiple Flash Terminal	47
Sync/Multiple Flash Terminal	47
PHOTOGRAPHIC TECHNIQUES	48~62
Synchro-Sunlight Fill-In Flash	
Photography	48~53
In the manual mode	50
In the TTL-automatic mode	51
In the non-TTL automatic mode	51
Synchronization with slow shutter speeds	52~53
Diffusing the Light	54~57
Bounce flash photography	54~56
Using a diffuser	57
Multiple Flash Photography	58~62
TTL multiple flash photography	59~61
Manual multiple flash photography	62
ACCESSORIES	63~65
Sync Cords SC-10, 11, and 15	63
TTL Remote Cord SC-14	63
TTL Remote Cord SC-17	63
TTL Multi-Flash Sync Cords	
SC-18 and SC-19	64
TTL Multi-Flash Adaptor AS-10	64
Flash Tripod Adaptor AS-11	64
Flash Unit Couplers AS-1, 4, 5, 6, and 7	64
Soft Flash Unit Case SS-16	65
"RED EYE"	65
TIPS ON SPEEDLIGHT CARE	66~67
OPTIMUM BATTERY PERFORMANCE	68
SPECIFICATIONS	69~70

ATTENTION!

The Nikon Speedlight SB-16 consists of two parts: the main flash unit and the flash unit coupler having the mounting foot. Depending on which type is attached, the flash unit is identified as the Speedlight SB-16A or SB-16B. The SB-16A's Flash Unit Coupler AS-8 has a special mounting foot for the accessory shoe of Nikon F3 series camera, while the SB-16B's Flash Unit Coupler AS-9 features a standard ISO-type mounting foot.

As shown in the table, the SB-16A and SB-16B can be mounted on any type of Nikon camera either directly or with the use of another Nikon Flash Unit Coupler. Usable shooting modes, however, are limited according to the combination of the flash unit and camera. Please reconfirm that the flash unit you purchased is suitable for your camera, referring to the following table.

Flash unit	Camera	Mounting	Usable shooting mode			
			TTL	A (automatic)	M (manual)	MD
SB-16A (with AS-8)	F3-series	Direct	●	●	●	●
	FA, FE2, F-501/N2020*, F-301/N2000*, FG, FM2, FG-20, EM, FE, FM	Via AS-6	—	●	●	●
	F2-Series	Via AS-5	—	●	●	●
	Nikonos-V	Via V-Type Sync Cord and AS-6	—	●	●	●**
SB-16B (with AS-9)	F3-series (except F3AF)***	Via AS-4 or AS-7	—	●	●	●
	FA, FE2, F-501/N2020*, F-301/N2000*, FG	Direct	●	●	●	●
	FM2, FG-20, EM, FE, FM	Direct	—	●	●	●
	F2-series****	Via AS-1	—	●	●	●
	Nikonos-V	Via V-Type Sync Cord	●	●	●	●**

*The Nikon N2020 and N2000 are sold exclusively in U.S.A. and Canadian markets.

**Motor drive is not available for the Nikonos-V camera.

***The SB-16B cannot be used with the Nikon F3AF or other F3-series cameras with the AF Finder DX-1, Action Finder DA-2, Waist-Level Finder DW-3 or 6X Magnification Finder DW-4 attached.

****The SB-16B cannot be mounted on the Nikon F2-series cameras with the Action Finder DA-1, Waist-Level Finder DW-1 or 6X Focusing Finder DW-2 attached.

Note: For more detailed information about shooting modes, refer to page 23.

FOREWORD

The Nikon Speedlight SB-16 is a direct-mounting electronic flash unit, providing automatic through-the-lens (TTL) control of the flash exposure when used with Nikon cameras having TTL flash capability. Through the use of an interchangeable mounting foot, the SB-16 can be attached to the special accessory shoe of all Nikon F3-series cameras, as well as the standard ISO-type shoe of the Nikon FA, FE2, F-501/N2020, F-301/N2000 and FG camera, or the V-type Sync Cord for the Nikonos-V. Because light is measured through the picture-taking lens, you are assured of just the right exposure with a variety of lenses and accessory attachments at any aperture from $f/2$ to $f/22$. Programmed TTL auto flash photography can be performed by using the SB-16 with the Nikon F-501/N2020 or F-301/N2000 via the AS-9. In programmed TTL auto flash photography, the proper aperture is automatically set for correct exposure according to the film speed in use. It is not necessary to change the lens setting from the minimum aperture used for non-flash programmed shooting.

Thanks to the incorporation of a front-mounted light sensor, the SB-16 is also compatible with all other Nikon cameras for automatic, but not through-the-lens, flash output control. In the non-TTL automatic mode, you have a choice of two apertures. With a silicon-controlled rectifier and series circuitry, the SB-16 is able to conserve energy when shooting subjects at close range; thus recycling times are shorter and the number of flashes per battery set is greater.

For truly creative bounce flash photography, the Nikon Speedlight SB-16 has two separate flash heads—a combination of tilting and rotating main flash head with zooming capability and a smaller secondary flash head which faces straight ahead to fill in the shadows in the eye sockets and provide a small catchlight for the eyes. Moreover, a special MD setting allows the SB-16 to synchronize with a motor-driven camera firing at 4 frames per second for shooting 8 pictures in series.

Even though the SB-16 is extremely easy to use, you should familiarize yourself with its “Basic Operation” as presented in the first section. For more detailed information, please refer to “Controls in Detail” and “Photographic Techniques.” A few minutes wisely invested now will pay off later in years of rewarding photographic experiences.

To insure proper service, make sure the Nikon Warranty Card is enclosed in the speedlight box.

BASIC OPERATION

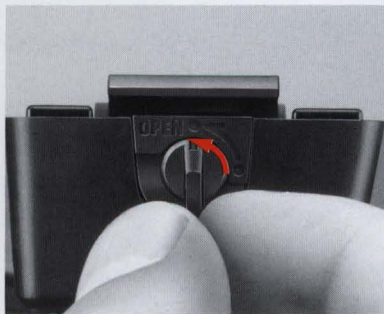

1. Set the open/closed knob ⑧ on the flash unit coupler to the OPEN position.



2. Attach the flash unit coupler to the flash unit.

Position the flash unit and flash unit coupler, so that the secondary flash head ④ on the flash unit and the sensor ⑦ on the flash unit coupler face the same direction. Insert the positioning claw ⑳ into the slot ⑤ on the flash unit.

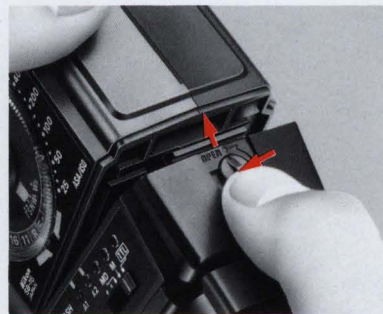

Then, while applying pressure to the open/closed knob, push the flash unit coupler into the flash unit until it clicks into place.

Note: If batteries have already been installed in the battery chamber, make sure the ON/OFF switch ㉑ is at the "off" position to avoid accidental firing.



3. Lock the flash unit coupler.

Turn the open/closed knob to the "closed" position (indicated by a dot) to lock the flash unit coupler; make sure the flash unit and flash unit coupler fit tightly together.

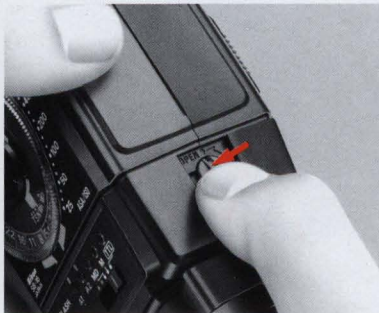

Note: To remove the flash unit coupler, set the knob to the OPEN position, and while applying pressure to the knob, gently pull the coupler off.



4. Remove the Battery Holder MS-5 23.

Open the battery chamber lid 24 by sliding it in the direction of the arrow and remove the battery holder.

Note: You may feel slight tension when removing or replacing the holder. This tension, however, can be ignored.

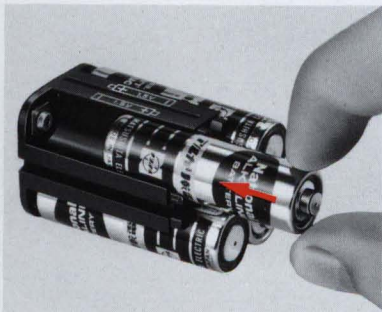

5. Load the batteries into the holder.

Load four 1.5V AA-type penlight alkaline-manganese cells or 1.2V rechargeable NiCd batteries into the holder, making sure that the positive and negative (+ and -) terminals match the diagrams on the holder.

Notes:

- 1) Use of manganese batteries is not recommended because their power is insufficient for operating the SB-16 at full capacity.
- 2) Do not mix brands or types of batteries. Also, avoid mixing new and old batteries since proper performance will not be obtained.



6. Replace the holder.

First, make sure the power switch ② of the flash unit is at the "off" position; then put the holder back into the chamber, so that the slots at both sides of the holder are aligned with the guide rails inside the battery chamber.



7. Close the lid.

While applying pressure to the battery holder with your finger, slide the lid as far as it will go until it clicks into place.

8. Attach the flash unit to the camera's accessory shoe.

Notes:

- 1) If you are using an F3-series camera, make sure that the ASA/ISO film speed is already set on the camera before attaching the flash unit, as the camera's ASA/ISO dial cannot be changed after the flash is attached to the accessory shoe.
- 2) For the Nikonos-V camera, an optional V-Type Sync Cord is required. For details about flash unit attachment to the Nikonos-V, refer to the Sync Cord's instruction manual.

With the SB-16A, turn the locking ring ⑩ around the mounting foot ④ counterclockwise until the AS-8's foot is uncovered (fig. 1). Then slide the mounting foot onto the camera's accessory shoe as far as it will go (fig. 2). Finally, tighten the locking ring to prevent the unit from accidentally slipping off (fig. 3).

With the SB-16B, turn the locking nut ⑩ on the mounting foot ⑪ counterclockwise until it reaches its upper limit (fig. 1). Then slide the mounting foot forward into the shoe as far as it will go (fig. 2). Finally, tighten the locking nut to prevent the unit from accidentally slipping off (fig. 3).

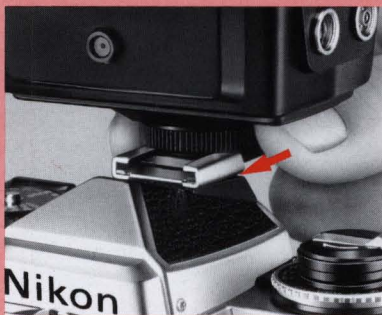



9. Tilt the flash head ② to the normal shooting position.

Tilt the flash head 90°, so that it faces straight ahead.



10. Set ASA/ISO film speed.

Turn the ASA/ISO film speed setting ring ⑩ around the exposure calculator dial ⑫, until the ASA/ISO index ⑬ is opposite the speed of the film loaded in your camera. Also confirm that the film speed is properly set on the camera.

Note: For TTL operation with the F3-series, FA, FE2, FG or Nikonos-V cameras, the usable film speed range is from ASA/ISO 25 to 400 (with no exposure compensation). With F-501/N2020 and F-301/N2000, the usable film speed range for TTL operation is ASA/ISO 25 to 1000.



11. Set the zoom head ⑱.

Pull out or push in the zoom head until the number indicated with an orange background matches the focal length of the lens on your camera. For lenses longer than 85mm, use the 85mm setting. For a 24mm lens, attach the Wide-Flash Adapter ① with the zoom head set at W₁. To prevent light falloff at the edges of the picture, do not use lenses wider than 24mm. In the example, the zoom head is set at 35 opposite the letter N.

Note: When the subject is closer than 1 meter, it is recommended that you use a zoom setting which is one step less than the lens focal length (e.g. use the 35mm setting with a 50mm lens).

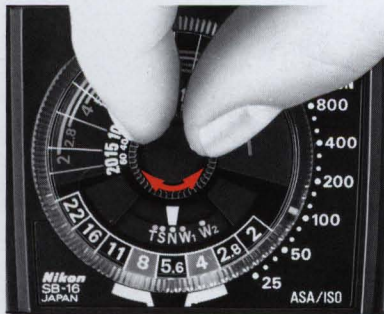

12. Set the zoom setting ³² knob on the exposure calculator dial.

Turn the zoom setting knob at the center on the dial until the zoom setting index ³⁶ is opposite the same letter as you selected in step 11.

Note: The *W₂* setting on the dial is used when the wide-flash adapter is attached to the flash unit with the zoom head set at *W₁*.



13. Set the shutter speed on the camera.

The proper shutter speed setting for flash synchronization of each camera is listed on page 21.

For example, set the shutter speed dial of F3-series cameras or the FE2 to A or set the shutter speed/mode selector of the FG to P or A.

Note: For TTL operation with a Nikon F3-series camera, the camera's backup mechanical release lever cannot be used with the shutter speed dial set at T (time). With the Nikon FA, FE2, FG or Nikonos-V, a mechanical shutter speed (i.e., M250, M90 or B) cannot be used for TTL operation.

Steps 14 through 17 are divided into three sections according to the shooting mode selected. Section A is for TTL automatic operation (with an F3-series, FA, FE2, F-501/N2020, F-301/N2000, FG, or Nikonos-V camera), section B is for non-TTL automatic operation, and section C is for programmed TTL auto operation (with the F-501/N2020 or F-301/N2000 camera set at a programmed exposure mode). For manual operation and synchronization with motor drive, see pages 23 and 24.

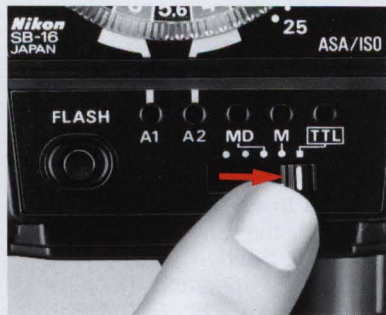

A-14. Set the SB-16's mode selector (45) to TTL.

Slide the mode selector to the right as far as it will go, so that the index on the selector is opposite the square mark for automatic through-the-lens (TTL) flash exposure control.

With the F-501/N2020 or F-301/N2000 camera, set the camera's exposure/shooting mode selector to A or a manual setting.



A-15. Choose an f/stop from the exposure calculator dial.

Depending on how far away your subject is from the camera, you must select an appropriate working aperture by referring to the calculator dial. You'll notice that each f/stop (from f/2 to f/22) has its own color-coded line (30) above the white distance scale (31) indicating the range

of distances at which you can shoot. For example, if you are using ASA/ISO 100 film with the zoom head set at N (35mm) and want to shoot subjects up to 4 meters (13 ft.) away, you can select f/8, f/4, f/2.8 or f/2. At f/4, the automatic shooting range indicates you can shoot any subject between 1.4 and 8.0 meters (4.6 and 26 ft.) away.

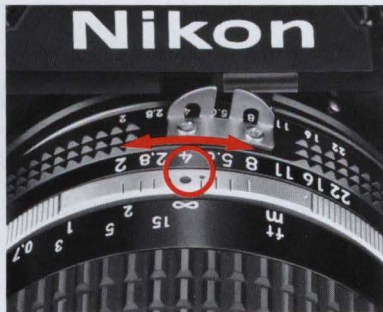

A-16. Set the lens aperture ring to the appropriate f/stop.

If you decide to shoot at $f/4$, then you must set the aperture ring on the lens to $f/4$.



B-14. Choose an f/stop from the exposure calculator dial.

For non-TTL automatic operation, the exposure calculator dial provides a choice of two f/stops. The blue and orange lines $\text{\textcircled{39}}$ at the bottom of the dial show the usable f/stops. For example, with ASA/ISO 100 film, you can choose $f/8$ or $f/4$. The auto shooting ranges with the zoom setting

at N (for a 35mm lens), are 0.6 to 4 meters (2.0 to 31 ft.) and 0.6 to 8 meters (2.0 to 26 ft.), respectively.

Note: The closest shooting distance for non-TTL automatic operation is always 0.6m (2.0 ft.) regardless of the film speed and aperture you select. With the zoom head set at T, however, the closest distance is 0.8m (2.6 ft.).

BASIC OPERATION—continued

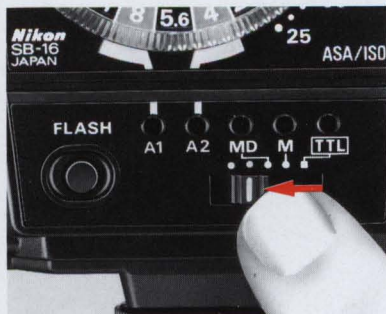

B-15. Set the mode selector  to the blue or orange dot for automatic operation.

If you select f/4, you must set the selector to the orange dot, corresponding to f/4 on the exposure calculator dial.

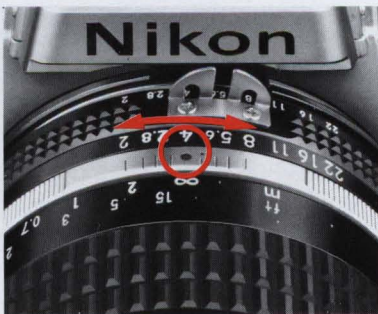

B-16. Set the lens aperture ring to the appropriate f/stop.

In the example, f/4 is set on the lens.

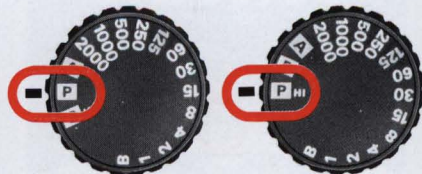

C-14. Set the exposure mode selector of the F-501/N2020 to P DUAL, P or PHI, or set the shooting mode selector of the F-301/N2000 to P or PHI.

For programmed TTL auto flash photography, use AI-S type lenses only.



C-15. Set lens to the minimum aperture (largest f-number).

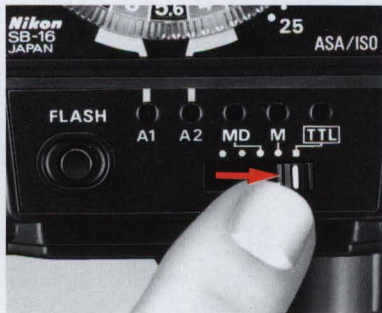

C-16. Set the SB-16's mode selector to TTL.



For TTL operation

For automatic operation (A2)

17. Turn on the flash unit.

Slide the SB-16's ON/OFF switch to the right. Immediately, an LED will light up (green LED for TTL operation, or red A1 or A2 LED for automatic operation).

Note: The LED may blink for a short while after the flash unit is turned on. This does not indicate a malfunction.



18. Wait for the ready-light ⁴⁶ to come on.

As soon as the flash ready-light built into the back of the flash unit comes on, the SB-16 is ready to fire. With the exception of the Nikon F2-series, if your camera has an LED ready-light inside the viewfinder, make sure that it is lit up, indicating that the SB-16 is ready to fire. Note that with the Nikon FA, FE2, F-501/N2020, F-301/N2000, FG, FG-20 or Nikonos-V, you must first turn on the exposure meter to activate the finder ready-light.

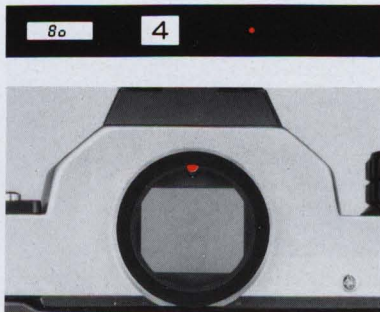

Notes:

- 1) **With the SB-16A and F3-series cameras**
If both ready-lights blink, make sure that:
 - a. The flash unit is securely locked in place.
 - b. The film speed setting on the camera is within the usable range when the flash unit is used in the TTL mode.

With the SB-16B and FA, FE2, F-501/N2020, F-301/N2000, FG or Nikonos-V

If the camera's ready-light blinks, check to see if:

- a. A mechanical setting is not used in the TTL mode.
- b. The film speed setting on the camera is within the usable range when the flash unit is used in the TTL mode.

For more detailed information about the ready-light warning, refer to page 37.

- 2) If the ready-light does not come on, first make sure the batteries are properly installed. If they are, replace them with a fresh set.



19. Take the picture.

When the shutter is tripped, both the main and secondary flashes fire as the picture is taken.

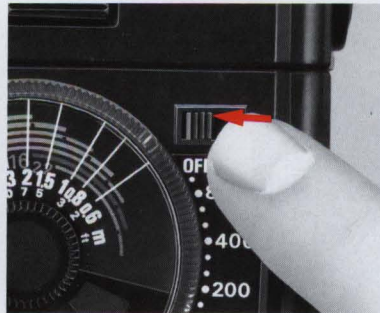
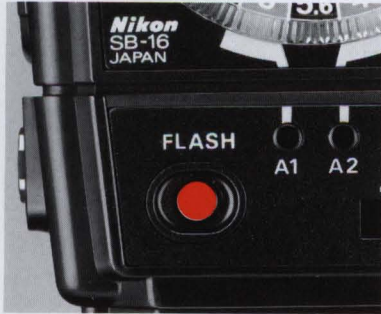

After you take the shot, watch the ready-light inside the camera's viewfinder or the one on the SB-16. After a short while, it will light up again to tell you the flash unit is recycled and ready to fire for the next shot.

Note: If the flash unit fired at its maximum output, the ready-light blinks as a warning immediately following the shot to indicate there still may be underexposure. In this case, check the combination of shooting distance and aperture selected, and use a wider aperture or move closer to the subject if necessary. This warning is also provided in the viewfinder of all Nikon cameras having a built-in ready-light (except F2-series cameras).

20. Turn off the flash unit.

To conserve battery power between shooting sessions, slide the power switch to the left.

CONTROLS IN DETAIL



AS-8



AS-9

Flash Unit Couplers AS-8 ⑩ and AS-9 ⑨

The detachable lower part of the SB-16, called the Flash Unit Coupler AS-8 or AS-9, houses the mounting foot, the shooting mode selector with shooting mode indication LEDs, the ready-light/open-flash button, the light sensor, the sync/multiple flash terminal ⑳, and the special terminal ㉑ for TTL multiple flash.

The only difference in appearance between the AS-8 and AS-9 is the type of mounting foot. The AS-8's mounting foot is specially designed for use with Nikon F3-series camera, while the AS-9 has a standard ISO-type mounting foot.

The flash unit with the AS-8 attached is identified as the Speedlight SB-16A, whereas the flash unit with the AS-9 as the Speedlight SB-16B. The SB-16A and SB-16B can be mounted on almost any type of Nikon camera* either directly or with the use of another Nikon Flash Unit

Coupler. The TTL automatic shooting mode, however, is available only when the SB-16A is used with a Nikon F3-series camera or when the SB-16B is used with either the Nikon FA, FE2, F-501/N2020, F-301/N2000, FG or Nikonos-V (via V-Type Sync Cord). For more detailed information about flash unit/camera combinations, refer to the table on page 5.

**Even with use of the Flash Unit Coupler AS-4 or AS-7, the SB-16B cannot be used with F3-series cameras with the AF Finder DX-1, Action Finder DA-2, Waist-Level Finder DW-3 or 6X Magnification Finder DW-4.*

Note: Be careful not to soil or damage the contact pins ㉒ on the coupler or the contacts ⑥ on the main flash unit as this may cause poor connection and possible malfunction.

Synchronization Speed

In flash photography, the shutter speed with which electronic flash will synchronize depends on the camera in use. The table shows the usable shutter speeds with various cameras. As shown in the table, automatic

sync speed setting is available with Nikon F3-series, FA, FE2, FE, F-501/N2020, F-301/N2000, FG, FG-20, EM and Nikonos-V cameras.

(sec.)

Nikon camera	Synchronization speed (sec.)	Camera setting	Actual shutter speed (sec.)	Viewfinder shutter speed indication
F3-series (via AS-4 or AS-7 coupler)	1/80 or slower	A*	1/80	80
		1/2000 – 1/125 sec.*	1/80	M80
		1/60 – 8 sec., X, B and T	as set	LCD shows manual-set shutter speed; no indication at B or T
FA	1/250 or slower	All shutter speed settings except M250 and B in P, S and A modes*	1/250	LCD shows 250
		1/4000 – 1/500 sec. in M mode*	1/250	LCD shows M250
		1/250 – 1 sec. in M mode	as set	LCD shows manually-set shutter speed
		M250 and B in P, S, A and M modes	as set	No indication
FE2	1/250 or slower	A, 1/4000 – 1/500 sec.*	1/250	—
		1/250 – 8 sec.	as set	—
		M250 and B	as set	—
FE**	1/125 or slower	AUTO*	1/90	—
		1/125 – B, B	as set	—
FM2 (with 1/250 sec. sync speed)**	1/250 or slower	1/250 – 1 sec., B	as set	—
FM2 (with 1/200 sec. sync speed)**	1/200 or slower	1/125 – 1, X200, B	as set	—
F-501/N2020	1/125 or slower	P DUAL, P PHI*	1/125	125 lights up
		A, 1/2000 – 1/250 sec.*	1/125	125 lights up and LED for proper non-flash shutter speed blinks
		1/125 – 1 sec. and B	as set	LED for manually-set shutter speed lights up, and LED for proper non-flash shutter speed blinks; no indication at B
F-301/N2000	1/125 or slower	PHI, P*	1/125	125 lights up
		A, 1/2000 – 1/250 sec.*	1/125	125 lights up and LED for proper non-flash shutter speed blinks
		1/125 – 1 sec. and B	as set	LED for manually-set shutter speed lights up, and LED for proper non-flash shutter speed blinks; no indication at B
FG	1/90 or slower	P, A, 1/1000 – 1/125 sec.*	1/90	Two LEDs representing 1/90 sec. light up
		1/60 – 1 sec.	as set	LED for manually-set shutter speed lights up
		M90 and B	as set	No indication
FG-20	1/90 or slower	A, (1/1000), 1/1000 – 1/125 sec.*	1/90	—
		1/60 – 1 sec., M90 and B	as set	—
		A, 1/1000 – 1/125 sec.	1/90	LED or proper non-flash shutter speed blinks
Nikonos-V (via V-Type Sync cord)	1/90 or slower	1/60 – 1/30 sec.	as set	LED for proper non-flash shutter speed blinks
		M90 and B	as set	No indication

*Automatic sync speed setting only occurs when the SB-16 is mounted in the camera's hot shoe and turned on; it does not occur when the SB-16 is turned off or when sync cord is used for off-camera operation.

**When the shutter speed dial setting is higher than flash sync speed, the camera's ready-light blinks as a warning.

CONTROLS IN DETAIL—continued



Zoom Head 18

The SB-16's zoom head has four settings which provide various angles of coverage as shown in the table.

The number with an orange background indicates that you can use a lens with the same or a longer focal length at that setting. However, please remember that the lower the numbered setting, the smaller the guide number and the narrower the automatic shooting range is. (The guide number and automatic shooting range for each zoom setting is shown in the table on pages 31 and 32.). To set the zoom head, simply pull it out or push it in until your desired number appears with an orange background behind it.

Notes:

- 1) With subjects closer than 1 meter, it is recommended that you select a setting with a one-stop smaller number than the focal length of the lens in use to reduce the amount of light at such close distances.
- 2) With the wide-flash adapter attached, you can use a 24 mm lens.

Zoom head setting	Usable lens	Angle of coverage	
		Vertical	Horizontal
T -----85	85mm or longer	23°	31°
S -----50	50mm or longer	34°	46°
N ----35	35mm or longer	45°	60°
W₁ -28	28mm or longer	53°	70°
W₁ (with wide-flash adapter)	24mm or longer	60°	78°

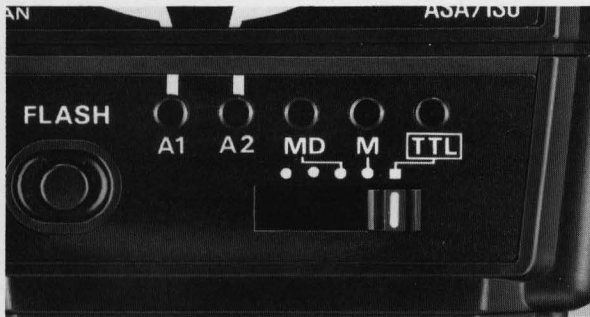

Shooting Mode Selector 45

The shooting mode selector on the back of the SB-16 has five click-stop settings. Directly above the selector (reading from left to right), there are the blue and orange dots for non-TTL automatic operation, two white dots in the middle indicating MD (Motor Drive) and M (Manual) operation respectively, and a white square at the far right which is for TTL operation.

As soon as the SB-16 is turned on, one of the appropriate LEDs (green for TTL and red for all the rest) above the selector lights up to indicate the setting selected.

Usable shooting modes depending on the combination of the type of the flash unit and camera are as listed on page 5.

TTL (through-the-lens automatic operation)

This mode provides automatic through-the-lens (TTL)

control of the flash exposure at any aperture from $f/2$ to $f/22$ to match the camera-to-subject distance: the farther away the subject, the more light emitted by the flash unit; the closer the subject, the less light given off. Because the exposure is measured through the lens, no exposure compensation is required in off-camera and/or bounce-flash operation or even with a teleconverter or filter attached to the lens.

This setting is also used for programmed TTL auto operation with F-501/N2020 and F-301/N2000.

A (non-TTL automatic operation)

In the non-TTL automatic (A) mode, the light output of the flash varies automatically to match the flash-to-subject distance, but instead of the light being measured through the lens, it is read by the light sensor on the front of the SB-16. At any film speed setting, you have a choice of two working apertures indicated by the blue A1 and orange A2 aperture indicator lines on the bottom of the exposure calculator dial.

M (manual operation)

At the manual (M) setting, the SB-16 fires at its maximum light output regardless of the flash-to-subject distance. When it is difficult to obtain correct exposure on auto, i.e., when the brightness of the background affects exposure strongly, use the SB-16 on manual. In the manual mode, exposure should be determined with the exposure calculator dial or with the guide number equation found on page 30.

CONTROLS IN DETAIL—continued

MD (synchronization with motor drive)

At the motor drive (MD) setting, the SB-16 is able to recycle fast enough to synchronize with a motor-driven camera firing continuously up to four frames per second. It is possible to take up to eight flash pictures in rapid succession in this way. At the MD setting, only the main flash head fires and the light output is approx. one-sixteenth that of the flash unit's maximum power. Like the M setting, this setting is also for manual operation; therefore, the exposure should be calculated manually using the exposure calculator dial or guide number equation shown on page 30.

Note: As sufficient power is required for the flash unit to synchronize with a motor drive, use the newest and freshest batteries whenever possible. For the same reason, avoid tripping the shutter immediately after the ready-light comes on, but wait for at least 30 seconds before beginning the motor drive sequence.



Exposure Calculator Dial ②

The exposure calculator dial on the back of the SB-16 helps you select the aperture you must set on the lens depending on the camera-to-subject/flash-to-subject distance. To use the dial, follow these steps:

1) Set the film speed

To set the ASA/ISO film speed, turn the ASA/ISO film speed setting ring until the number corresponding to the speed of your film is opposite the ASA/ISO film speed index. Dots between the numbers on the film speed scale represent intermediate settings.



2) Set the zoom setting knob

Turn the zoom setting knob at the center on the dial until the zoom setting index is opposite the same letter as you selected in setting the zoom head. For example, if you set the zoom head at T for a 85mm lens, the zoom setting knob must also be set at T.

Note: The W_2 setting on the dial is used when the wide-flash adapter is attached to the flash unit with the zoom head set at W_1 .

3) Determine the exposure

Depending on which shooting mode you've selected, read off the usable f/stop(s) from the dial. In either the TTL or non-TTL automatic mode, more than one f/stop is usable. When choosing an aperture, make sure that your subject is within the auto shooting range indicated by the color-coded lines. The larger the aperture (the smaller the f-number) you select, the greater the maximum shooting distance, whereas the smaller the aperture (the larger the f-number), the less the maximum shooting distance. If the subject distance remains the same, the larger the aperture you select, the less depth of field in the final photograph; however, the recycling time is shorter. On the other hand, the smaller the aperture, the greater the depth of field, but the recycling time is longer. Therefore, in choosing an f/stop, all these factors should be taken into consideration.

CONTROLS IN DETAIL—continued

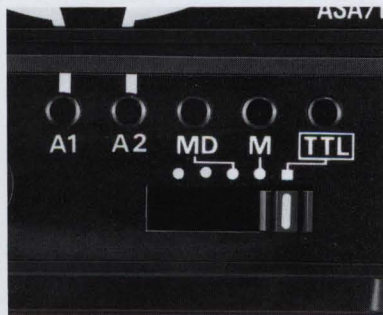

For through-the-lens (TTL) operation

On the dial there are eight f/stops ranging from f/2 to f/22. Each f/stop determines the usable distance range in which you can obtain the correct automatic exposure. These ranges are indicated by a series of color-coded lines above the distance scale.

For programmed TTL operation, it is not necessary to select the lens aperture. Once the lens is set to its minimum aperture, the camera automatically selects the proper aperture according to the lens in use. For information on the aperture selected and automatic shooting range, see page 27.

Example 1

If you are using ASA/ISO 100 film (with the zoom head set at N for a 35mm lens) and select f/4, the auto shooting range is indicated by an orange line. Thus, you can take pictures of subjects located between 1.4 and 8.0m (approx. 4.6 and 26 ft.) from the camera.

Example 2

If you are using ASA/ISO 400 film (with the zoom head set at T for an 85mm lens) and select f/4, the auto shooting range indicated by the orange line this time is 3.8 to 21m (approx. 12 to 69 ft.).

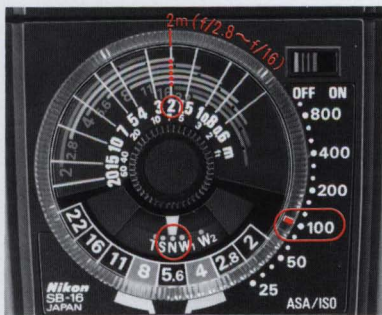

Example 3

If you are using ASA/ISO 100 film (with the zoom head set at N for a 35mm lens) and the subject is 2m away, you can select either f/2.8, f/4, f/5.6, f/8, f/11 or f/16. If a shorter recycling time is preferable, use f/2.8. If greater depth of field is desired, use f/16.

The auto shooting ranges for TTL photography are shown in the following table.

TTL auto shooting range

Unit: m (ft)

		Film speed (ASA/ISO)						Zoom head setting					
		1000*	800*	400	200	100	50	25	T	S	N	W ₁	W ₂ **
f/stop	2.8+1/3	2.8	2	—	—	—	—	—	7.5-30 (25-98)	6.8-30 (22-98)	6.0-30 (20-98)	4.8-26 (16-85)	3.4-19 (11-62)
	4+1/3	4	2.8	2	—	—	—	—	5.3-29 (17-95)	4.8-26 (16-85)	4.0-22 (13-72)	3.4-19 (11-62)	2.4-13 (7.9-43)
	5.6+1/3	5.6	4	2.8	2	—	—	—	3.8-21 (12-69)	3.4-9 (11-62)	3.0-16 (9.8-52)	2.4-13 (7.9-43)	1.7-9.5 (5.6-32)
	8+1/3	8	5.6	4	2.8	2	—	—	2.7-14 (8.9-46)	2.4-13 (7.9-43)	2.0-11 (6.6-36)	1.6-9.5 (5.2-31)	1.2-6.7 (3.9-22)
	11+1/3	11	8	5.6	4	2.8	2	—	1.9-10 (6.2-33)	1.7-9.5 (5.6-31)	1.4-8.0 (4.6-26)	1.2-6.7 (3.9-22)	0.9-4.7 (3.0-15)
	16+1/3	16	11	8	5.6	4	2.8	—	1.4-7.4 (4.6-24)	1.2-6.7 (3.9-22)	1.0-5.6 (3.3-18)	0.9-4.7 (3.0-15)	0.6-3.3 (2.0-11)
	—	—	22	16	11	8	5.6	4	1.0-5.2 (3.3-17)	0.9-4.7 (3.0-15)	0.7-4.0 (2.3-13)	0.6-3.3 (2.0-11)	0.6-2.3 (2.0-7.5)
	—	—	—	22	16	11	8	5.6	0.8-3.7 (2.6-12)	0.6-3.3 (2.0-11)	0.6-2.8 (2.0-9.2)	0.6-2.3 (2.0-7.5)	0.6-1.6 (2.0-5.2)
	—	—	—	—	22	16	11	8	0.8-2.6 (2.6-8.5)	0.6-2.3 (2.0-7.5)	0.6-2.0 (2.0-6.6)	0.6-1.6 (2.0-5.2)	0.6-1.1 (2.0-3.6)
	—	—	—	—	—	22	16	11	0.8-1.8 (2.6-5.9)	0.6-1.6 (2.0-5.2)	0.6-1.4 (2.0-4.6)	0.6-1.1 (2.0-3.6)	0.6-0.8 (2.0-2.6)

*For Nikon F-501/N2020 and F-301/N2000 only.

**W₂ is used when the wide-flash adapter is attached to the flash unit with the zoom head set at W₁

= Programmed TTL auto flash information.

CONTROLS IN DETAIL—continued

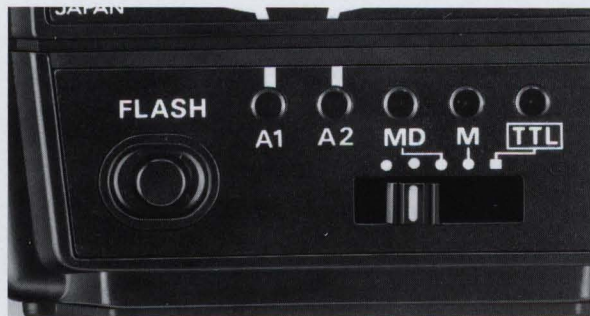

For non-TTL automatic (A) operation

For non-TTL automatic operation, you can select one of two f /stops, indicated by the blue and orange aperture indicator lines at the bottom of the calculator dial. After determining the aperture, set the shooting mode selector corresponding to the aperture you selected.



Example 1

If you are using ASA/ISO 100 film (with the zoom head set at N for a 35mm lens), the usable aperture is $f/8$ at the blue A1 setting and $f/4$ at the orange A2 setting. The automatic shooting range in this case is 0.6 to 4.0m (2.0 to 13 ft.) at A1 and 0.6m to 8.0m (1.0 to 26 ft.) at A2. For a subject more than 4m away, the only usable f /stop is $f/4$. With a subject 3m away, you can select either $f/8$ or $f/4$. If a shorter recycling time is preferable, use $f/4$. If greater depth of field is desired, use $f/8$.

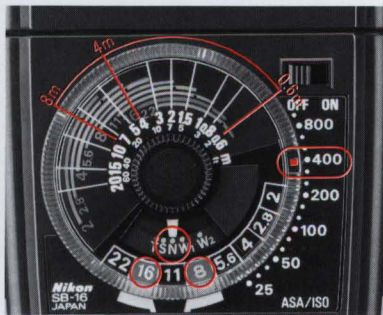

Example 2

If you are using ASA/ISO 400 film, the usable aperture is now f/16 at A1 and f/8 at A2.

The auto shooting range varies according to the zoom head setting as shown in the table. At the same zoom head setting, the range is the same regardless of the film speed and the corresponding f/stop available at A1 or A2. As you can see in the table, the closest subject distance is always 0.6m (2.0 ft.) except at the T setting of the zoom head.

Note: Regardless of the settings on the exposure calculator dial, any film speed can be used for non-TTL automatic operation.

Auto shooting range

Unit: m (ft)

Zoom head setting	Shooting mode	Shooting range
T	A1	0.8-5.2 (2.6-17)
	A2	0.8-10 (2.6-33)
S	A1	0.6-4.7 (2.0-15)
	A2	0.6-9.5 (2.0-31)
N	A1	0.6-4.0 (2.0-13)
	A2	0.6-8.0 (2.0-26)
W ₁	A1	0.6-3.3 (2.0-11)
	A2	0.6-6.7 (2.0-22)
W ₂ *	A1	0.6-2.3 (2.0-7.5)
	A2	0.6-4.7 (2.0-15)

* W₂ is used when the wide-flash adapter is attached to the flash unit with the zoom head set at W₁.

CONTROLS IN DETAIL—continued



For manual (M) operation

After setting the ASA/ISO film speed and zoom setting knob on the exposure calculator dial, focus on the subject; then look at the lens and read off the focused distance to determine exactly how far away the subject actually is. Now, find the end of the color-coded line directly above the flash-to-subject distance and read off the f-number next to this line. Then, set this aperture on your lens.

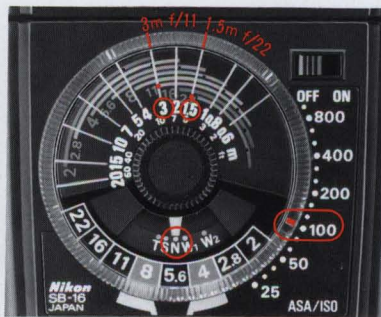

Example

When using ASA/ISO 100 (with the zoom head set at N for a 35mm lens) and the subject is located 1.5m (5.0 ft.) away, the correct aperture is approx. f/22. With a subject 3m (10 ft.) away, the aperture is approx. f/11.

Without referring to the exposure calculator dial, you can also determine the f/stop by using the following equation:

$$f/\text{stop} = \frac{\text{guide number}}{\text{flash-to-subject distance}}$$

With ASA/ISO 100 film and meters (and the zoom head set at N for a 35mm lens), the SB-16's guide number is 32. If the subject is 4m away, divide 32 by 4 to get f/8. With ASA/ISO 25 film and feet (and zoom head set at N for a 35mm lens), the guide number is 52. Therefore, if the subject is 20 ft. away, divide 52 by 20 to get approx. f/2.8.

The guide number at various film speeds and zoom head settings is shown in the following table:

Guide numbers in the manual mode

Unit: m (ft)

Zoom head setting	ASA/ISO film speed					
	800	400	200	100	50	25
T	119 (390)	84 (276)	59 (194)	42 (138)	30 (98)	21 (69)
S	107 (351)	76 (250)	54 (177)	38 (125)	27 (89)	19 (62)
N	90 (295)	64 (210)	45 (148)	32 (105)	22 (72)	16 (52)
W₁	76 (250)	54 (177)	38 (125)	27 (89)	19 (62)	13 (43)
W₂*	54 (177)	38 (125)	27 (89)	19 (62)	13 (43)	9.5 (31)

* W₂ is used when the wide-flash adapter is attached to the flash unit with the zoom head set at W₁.

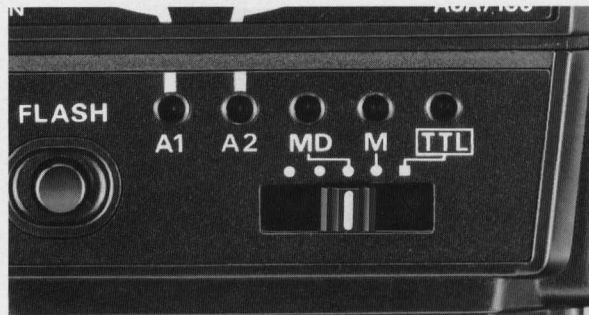

For motor drive (MD) operation

After setting the ASA/ISO film speed and zoom setting knob on the exposure calculator dial, focus on the subject; then look at the lens and read off the focused distance to determine exactly how far away the subject actually is.

CONTROLS IN DETAIL—continued

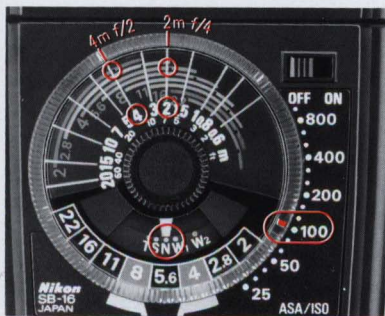

Now, you are ready to read the usable f/stop from the dial. Each color-coded line indicating the auto shooting range for each f/stop has a notch on it. Find the notch directly above the flash-to-subject distance and read the f-number at the end of the line.

Example

With ASA/ISO 100, zoom head set at N for 35mm lens, a subject 2m (6.6 ft.) away, the aperture is approx. f/4. With a subject 4m (13 ft.) away, the aperture is f/2.

Without referring to the exposure calculator dial, you can also determine the f/stop by using the guide number equation found on page 30.

The guide number at various film speeds and zoom head settings is shown in the following table:

Guide numbers in the MD mode

Unit: m (ft)

Zoom head setting	ASA/ISO film speed					
	800	400	200	100	50	25
T	30 (98)	21 (69)	14 (46)	10 (33)	7 (23)	5 (16)
S	27 (89)	19 (62)	13 (43)	9.5 (31)	6.7 (22)	4.7 (15)
N	22 (72)	16 (52)	11 (36)	8 (26)	5.6 (18)	4 (13)
W₁	19 (62)	13 (43)	9.5 (31)	6.7 (22)	4.8 (16)	3.3 (11)
W₂*	12 (39)	8.4 (28)	5.9 (19)	4.2 (14)	3 (9.8)	2.1 (6.9)

* W₂ is used when the wide-flash adapter is attached to the flash unit with the zoom head set at W₁.

Exposure compensation

In TTL or non-TTL automatic operation with a dark subject (one with low reflectivity) or one light in tone (having high-reflectivity), over- or underexposure may occur. To prevent this, exposure compensation is required.

Note: If you photograph a subject of very high reflectivity, such as when shooting directly into a mirror or metallic surface, underexposure is certain to occur. In this case, take the picture on manual.

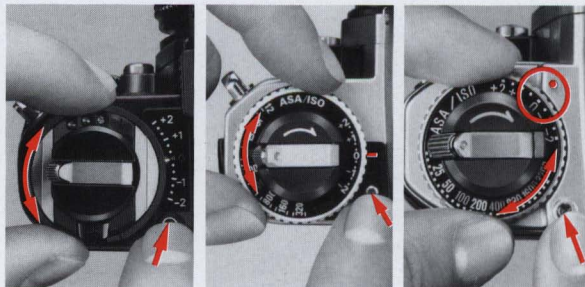

TTL exposure compensation

When shooting TTL auto flash pictures, you can use the camera's exposure compensation dial (or the exposure compensation button also available when using the Nikon FG) in the normal way to make exposure compensation according to the shooting situation or to make intentionally over- or underexposed photographs.

Turn the dial in the + direction to give more exposure and turn it in the opposite (-) direction to give less exposure (refer to the camera's instruction manual for more information). The TTL auto shooting range changes according to the amount of exposure compensation.

CONTROLS IN DETAIL—continued



For example, if you are using ASA/ISO 100 film with the exposure compensation dial set at +2 (overexposure), you can read 25 from the table. Reset the exposure calculator dial of the SB-16 to ASA/ISO 25, and then the correct TTL auto shooting range to match the compensated amount will be shown on the exposure calculator dial.

ASA/ISO film speed to set for TTL exposure compensation

Exposure compensation value \ Film speed in use	+2	+1	0	-1	-2
25	⎓	⎓	25	50	100
50	⎓	25	50	100	200
100	25	50	100	200	400
200	50	100	200	400	800*
400	100	200	400	800*	⎓
800*	200	400	800	⎓	⎓
1000*	250	500	1000	⎓	⎓

*For Nikon F-501/N2020 and F-301/N2000 only

⎓ = Not possible; make the necessary compensation in the non-TTL automatic mode (see the following) or shoot on manual.



Non-TTL automatic exposure compensation

In the non-TTL automatic exposure mode, exposure compensation can be performed by stopping down or opening up the lens. With a dark subject, use a smaller aperture. When a subject is light in tone, use a larger aperture.

CONTROLS IN DETAIL—continued



F3-series



FA

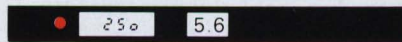

FE2



FE



FM2



F-501/N2020,
F-301/N2000



FG



FG-20

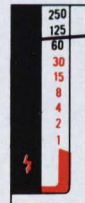

Ready-Light ④

After the ON/OFF switch is turned on, the ready-light at the back of the SB-16 lights up to indicate that the SB-16 is recycled and ready to fire. At the same time, the ready-light inside the viewfinder of all Nikon F3-series cameras, in addition to the FA, FE2, FM2, FE, F-501/N2020, F-301/N2000, FG, FG-20, EM and Nikonos-V also lights up. Thus, without removing your eye from the eyepiece, you can tell when the flash unit is ready for the next shot.

Notes:

- 1) With the Nikon FA, FE2, F-501/N2020, F-301/N2000, FG, FG-20 or Nikonos-V, the meter must first be turned on by depressing the shutter release button halfway to activate the ready-light function.
- 2) The ready-light will light up when the SB-16 is recycled to approx. 80% full capacity. Therefore, it is a good idea to wait for a few more seconds when shooting subjects located at the far limit of the auto shooting range.
- 3) With alkaline-manganese batteries, if the ready-light takes more than 30sec. to light up, you should replace the batteries with a fresh set.
- 4) The voltage of NiCd batteries decreases rapidly when their power is almost exhausted, increasing the recycling time. When this occurs, stop using them immediately and recharge them or they may be damaged.

Warning functions

In the TTL or non-TTL automatic mode, both the ready-lights on the flash unit and in the camera's viewfinder blink for 3 seconds after the flash unit fired at its maximum output, indicating that the light might have been insufficient for correct exposure. In this case, check the subject distance and if it is out of the automatic shooting range, use a wider aperture if possible or move closer to the subject. Because the voltage of batteries decreases with use, the guide number might also be reduced slightly. The flash output of the SB-16 depends on the available ambient light and the reflectivity of the subject. Note that, because of these factors, the ready-light may blink to indicate that the light output was insufficient for correct exposure, even if the subject is within the auto shooting range.

Other warnings shown by the ready-light's blinking vary according to the type of flash unit and the camera in use. (For more detailed information, refer to the tables on the following pages.)

CONTROLS IN DETAIL—continued

With the SB-16A

As soon as the flash unit is turned on, both ready-lights blink in the following cases:

- 1) When the AS-8's mounting foot is not securely locked.
- 2) When using the TTL mode with the Nikon F3-series camera and the camera's film speed setting is set well beyond the usable range of ASA/ISO 25~400, without exposure compensation.
- 3) When the shooting mode selector is set at TTL with any camera other than the Nikon F3-series.

Note that when the shutter speed setting on the Nikon FE or FM2 is improper for correct flash synchronization and the camera's meter is on (only in the case of the FE), just the camera's ready-light blinks as a warning, while the one on the flash unit does not blink but simply lights up to indicate when the flash is ready to fire.

Camera	Shutter speed Setting (sec.)	Shooting mode	SB-16A's ready-light	Camera's ready-light	
				Meter ON	Meter OFF
F3-series	All settings	TTL	Lights up*	Lights up*	Lights up*
		A1, A2, M, MD	Lights up**	Lights up**	Lights up**
FA via AS-6	All settings except M250 and B (in P, S, A and M modes)	TTL	Blinks	Blinks	Does not light up
		A1, A2, M, MD	Lights up**	Lights up**	Does not light up
FE2 via AS-6	All settings except M250 and B	TTL	Blinks	Blinks	Blinks
		A1, A2, M, MD	Lights up**	Lights up**	Lights up**
FE via AS-6	M250, B (in P, S, A and M modes)	TTL	Blinks	Blinks	Does not light up
		A1, A2, M, MD	Lights up**	Lights up**	Does not light up
FM2 (with 1/250 sec. sync speed) via AS-6	1/250 or slower	TTL	Blinks	Blinks	Blinks
		A1, A2, M, MD	Lights up**	Lights up**	Lights up**
FM2 (with 1/200 sec. sync speed) via AS-6	1/200 (×200) or slower	TTL	Blinks	Blinks	Blinks
		A1, A2, M, MD	Lights up**	Lights up**	Lights up**
F-501/N2020 via AS-6, F-301/N2000 via AS-6	All settings	TTL	Blinks	Blinks	Does not light up
		A1, A2, M, MD	Lights up**	Lights up	Does not light up
FG via AS-6	All settings except M90 and B	TTL	Blinks	Blinks	Does not light up
		A1, A2, M, MD	Lights up**	Lights up**	Does not light up
FG-20 via AS-6	M90, B	TTL	Blinks	Blinks	Blinks
		A1, A2, M, MD	Lights up**	Lights up**	Lights up**
Nikonos-V via V-Type Sync Cord and AS-6	All settings except M90 and B	TTL	Blinks	Blinks	Does not light up
		A1, A2, M, MD	Lights up**	Lights up**	Does not light up
	M90, B	TTL	Blinks	Blinks	Blinks
		A1, A2, M, MD	Lights up**	Lights up**	Lights up**

* It blinks when the film speed setting on the camera is beyond the usable range for the TTL mode or when the mounting foot is not securely locked.

** It blinks when the mounting foot is not securely locked.

*** It blinks irregularly.

= Proper flash synchronization is impossible due to improper setting of shutter speed or shooting mode.

Note: With a mechanical shutter speed set on the camera, the camera's exposure meter remains off even if you depress the shutter release button.

CONTROLS IN DETAIL—continued

With the SB-16B

As soon as the flash unit is turned on, the ready-light on the flash unit lights up when the flash is ready to fire, while the ready-light in the camera's viewfinder blinks in the following cases:

- 1) When the shooting mode selector is set at TTL with any camera other than the Nikon FA, FE2, F-501/N2020, F-301/N2000, FG, or Nikons-V.
- 2) When using the FA, FE2, FG or Nikonos-V to perform TTL automatic flash photography with the camera's shutter speed dial set at a mechanical setting (M250, M90 or B). The B setting on the F-501/N2020 and F-301/N2000 camera is not a mechanical setting; you can use any setting on the camera's shooting mode selector.
- 3) When using the FA, FE2, F-501/N2020, F-301/N2000, FG or Nikonos-V to perform TTL automatic flash photography with a camera film speed setting over the usable range, without exposure compensation (or when using DX-coded film with film speed higher than ISO 1000 for the F-501/N2020 and F-301/N2000). Make sure to use film within the usable range for TTL flash photography (ISO 25 to 400 with the FA, FE2, FG or Nikonos-V, or ISO 25 to 1000 with the F-501/N2020 and F-301/N2000).
With the FA, the ready-light also blinks when the film speed setting on the camera is near ISO 12, with or without exposure compensation in the + direction.
- 4) When the shutter speed setting on the FM2 or FE is improper for flash synchronization and the camera's meter is on (only in the case of the FE).

Camera	Shutter speed Setting (sec.)	Shooting mode	SB-16B's ready-light	Camera's ready-light	
				Meter ON	Meter OFF
F3-series via AS-4 or 7	All settings	TTL	Lights up	Blinks	Blinks
		A1, A2, M, MD	Lights up	Lights up	Lights up
FA	All settings except M250 and B (in P, S, A and M modes)	TTL	Lights up	Lights up*	Does not light up
		A1, A2, M, MD	Lights up	Lights up	Does not light up
	M250, B (in P, S, A and M modes)	TTL	Lights up		Blinks
		A1, A2, M, MD	Lights up		Lights up
FE2	All settings except M250 and B	TTL	Lights up	Lights up*	Does not light up
		A1, A2, M, MD	Lights up	Lights up	Does not light up
	M250, B	TTL	Lights up		Blinks
		A1, A2, M, MD	Lights up		Lights up
FE	AUTO, 1/125 or slower	TTL	Lights up	Blinks	Blinks
		A1, A2, M, MD	Lights up	Lights up	Lights up
	1/250 or faster	TTL	Lights up	Blinks**	Blinks
		A1, A2, M, MD	Lights up	Blinks	Lights up
FM2 (with 1/250 sec. sync speed)	1/250 or slower	TTL	Lights up	Blinks	Blinks
		A1, A2, M, MD	Lights up	Lights up	Lights up
	1/500 or faster	TTL	Lights up	Blinks**	Blinks**
		A1, A2, M, MD	Lights up	Blinks	Blinks
FM2 (with 1/200 sec. sync speed)	1/200 (×200) or slower	TTL	Lights up	Blinks	Blinks
		A1, A2, M, MD	Lights up	Lights up	Lights up
	1/250 or faster	TTL	Lights up	Blinks**	Blinks**
		A1, A2, M, MD	Lights up	Blinks	Blinks
F-501/N2020, F-301/N2000	All settings	TTL	Lights up	Lights up*	Does not light up
		A1, A2, M, MD	Lights up	Lights up	Does not light up
FG	All settings except M90 and B	TTL	Lights up	Lights up*	Does not light up
		A1, A2, M, MD	Lights up	Lights up	Does not light up
	M90, B	TTL	Lights up		Blinks
		A1, A2, M, MD	Lights up		Lights up
FG-20	All settings except M90 and B	TTL	Lights up	Blinks	Does not light up
		A1, A2, M, MD	Lights up	Lights up	Does not light up
	M90, B	TTL	Lights up		Blinks
		A1, A2, M, MD	Lights up		Lights up
Nikonos-V via V-Type Sync Cord	All settings except M90 and B	TTL	Lights up	Lights up*	Does not light up
		A1, A2, M, MD	Lights up	Lights up	Does not light up
	M90, B	TTL	Lights up		Blinks
		A1, A2, M, MD	Lights up		Lights up

* It blinks when the film speed setting on the camera is beyond the usable range for the TTL mode.

** It blinks irregularly.

 = Proper flash synchronization is impossible due to improper setting of shutter speed or shooting mode.

Note: With a mechanical shutter speed set on the camera, the camera's exposure meter remains off even if you depress the shutter release button.

CONTROLS IN DETAIL—continued

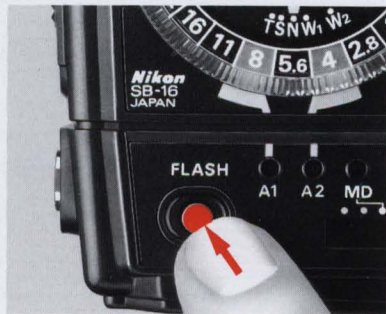

Open-Flash Button ④⑥

The ready-light on the SB-16 can be used as an open-flash button to fire the flash unit manually without having to trip the camera's shutter. In this manner, you can create multiple-exposure "stroboscopic" effects or paint the scene with light by firing the flash unit repeatedly with the camera set at B. In this case, make sure that the flash unit is not connected to the camera.

The open-flash button is also useful for test-firing the SB-16 to determine whether the illumination from the flash was sufficient for proper exposure in the non-TTL automatic mode. With the shooting mode selector set at one of the color-coded dots (A1 or A2), push the "FLASH" button; if it starts blinking, then you know the amount of light might have been insufficient for the subject. In this case, reset the selector to A1 if it was set at A2, or move closer to the subject. This test-firing is especially useful when the flash head is tilted and/or rotated for bounce flash.

In the TTL mode, test-firing must be performed by tripping the shutter. Note that, without film loaded in the camera, the ready-light will blink even if the correct exposure is obtainable. As a substitute for loaded roll film, you can use a strip of cut film (provided it is not too old) or a piece of gray paper.

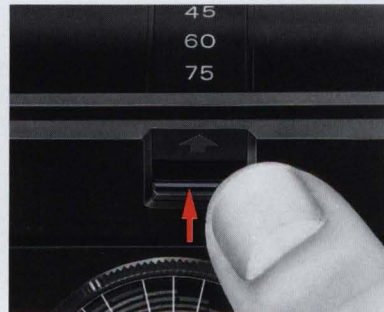
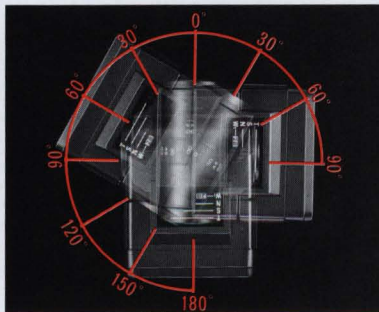
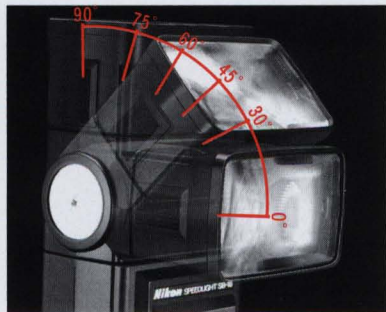

Tilting/Rotating Flash Head ②

For truly creative bounce flash photography, the SB-16 has two flash heads.

The main head tilts back 90° with click-stops at the 30°, 45°, 60°, 75° and 90° positions. It also rotates through an arc or 270°, 90° clockwise with click stops at 30°, 60° and 90° positions, and 180° counterclockwise with click-stops at 30°, 60°, 90°, 120°, 150° and 180° positions. To rotate it, push the flash head locking lever ② up as you move the flash head until it clicks into place.

Notes:

- 1) In the MD mode, only the main head fires.
- 2) A special red LED is built into one end of the flashtube to ensure stable light output. If you release the camera's shutter or push the open-flash button before the SB-16 is fully recycled, the LED might light up—this not a malfunction.



Secondary Flash Head ④

The smaller secondary head is built into the front of the flash unit and faces straight ahead. Its purpose is to fill in the shadows in the eye sockets and provide a catch-light for the eyes when doing bounce flash. The secondary head has a guide number of 8.

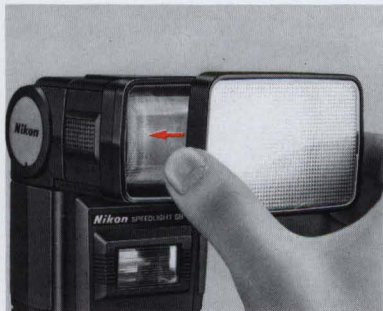

Wide-Flash Adapter SW-7 ①

The Wide-Flash Adapter attached in front of the SB-16's main flash head with the zoom head set at W_1 (for a 28mm lens) increases the angle of coverage from the 70° horizontal and 53° vertical to 78° and 60° respectively, allowing the SB-16 to be used with a 24mm wide-angle lens. With the SW-7 attached, remember to set the zoom head knob on the exposure calculator dial at W_2 .

Because the SW-7 diffuses the light emitted from the SB-16, the guide number is reduced to 19 at ASA/ISO 100 and meters (refer to pages 31 and 32), and the auto shooting ranges are less (refer to page 27 for the TTL auto shooting ranges and page 29 for the non-TTL auto shooting ranges).



TTL Multiple Flash Terminal ⑳

The TTL multiple flash terminal is provided for TTL multiple flash photography. (For more information, refer to pages 58—61.)



Sync/Multiple Flash Terminal ㉑

Located at the side of the AS-8 or AS-9 is a threaded terminal which serves two purposes: it can be used to attach a sync cord to the SB-16 for off-camera operation or you can attach a second electronic flash in series for manual multiple lighting setups. (For more detailed information about manual multiple flash, refer to pages 58 and 62.)

Notes:

- 1) When the SB-16 is used off-camera via a sync cord, ready-light indication inside the camera's viewfinder and automatic sync speed setting are not available, and TTL auto flash operation cannot be performed.
- 2) When attached to an all-metallic accessory shoe, such as the one on the Nikkormat FTN camera, the SB-16 does not fire even if it is connected to the camera body with a sync cord. In this case, isolate the flash contact with vinyl tape or use the optional accessory sync cord, SC-10 as required.

PHOTOGRAPHIC TECHNIQUES

Synchro-Sunlight Fill-In Flash Photography

A backlit subject, such as a person outside with his/her back to the sun or indoors in front of a window, may come out almost as a silhouette if the background is correctly exposed. On the other hand, if exposure compensation is made to give the correct exposure for a backlit subject, the background may be washed out. To fill in the shadows and balance the illumination levels of the subject and background, you can use an electronic flash unit even in daytime.

One important fact to remember in balancing the exposure for both subject and background is this: *Exposure with a flash unit is determined only by the aperture selected, whereas exposure for ambient daylight is determined by a combination of shutter speed and aperture.*



Without flash or exposure compensation: the backlit subject comes out too dark.



Without flash, but with the exposure compensation dial set at +2: the subject's face is correctly exposed, but the background is too bright.



With fill-in flash: both the subject and the background come out properly exposed.

PHOTOGRAPHIC TECHNIQUES—continued

Synchro-sunlight fill-in flash photography is possible with the SB-16's shooting mode selector set to the TTL-automatic, non-TTL automatic, or manual mode.

Operation in the manual mode assures you of good results in virtually all cases, so we will describe this procedure first.

In the manual mode

1) Set the shutter speed on the camera manually. Set the camera manually to the highest synchronization speed for electronic flash or a slower one.

2) Take a meter reading of the background. Frame the background in the camera's viewfinder, so that the backlit subject is not included. Turn on the camera's exposure meter to determine the proper f/stop for the shutter speed you have set.

3) Determine the flash-to-subject distance. Using the equation below, calculate the flash-to-subject distance using the guide number for the film in use (as shown on page 31) and the f/stop set on the lens:

$$\text{flash-to-subject distance} = \frac{\text{guide number}}{\text{f/stop}}$$

4) Position the SB-16 at the correct distance. Set the flash-to-subject distance on the lens distance scale; then move in and out until the subject appears sharp in the camera's viewfinder. To vary the composition, you can use a wideangle-to-telephoto zoom lens. As an alternate

method, remove the flash unit from the camera using a separate sync cord and position it at the correct distance; then you can shoot from any position.

5) Take the picture. Set the SB-16 for manual operation, turn it on and wait until it is fully recycled before taking the shot.

This procedure balances the exposure for the subject with that of the background. However, in synchro-sunlight fill-in flash photography, it is a good idea to use the light from the flash unit as a secondary light by decreasing the flash illumination by approx. one or two stops to eliminate harsh shadows caused by the ambient daylight. There are two ways of decreasing flash illumination. One is to use an aperture that's one or two f/stops smaller than that determined in step 2) in combination with a shutter speed that should be slower by one or two steps to give the background a correct exposure; the other is to use a flash-to-subject distance 1.4 or two times longer than that determined through the equation. You will obtain more natural-looking results with either method. You can also combine the two methods. Some photographers prefer to overexpose the background by one stop in order to create an intentionally backlit effect by using a shutter speed that's slower by a further one step.

In the TTL-automatic mode

- 1) Same as Steps 1) and 2) in the manual mode.
- 2)
- 3) **Take the picture.** With the SB-16 set at TTL and turned on, just take the picture.

Notes:

- 1) *With a strongly backlit subject (such as a scene containing the sun), the desired exposure balance may not be obtained. In this case, use the SB-16 on manual.*
- 2) *To give different exposures to the subject and background, you can re-set the camera's shutter speed dial and exposure compensation dial accordingly. For example, use a slower shutter speed to make the background overexposed and turn the exposure compensation dial in the - direction to make the subject underexposed.*

In the non-TTL automatic mode

- 1) **Set a shooting aperture on the lens.** Read off the two usable apertures from the exposure calculator dial and set one of them on the lens.
- 2) **Take a meter reading of the background.** Frame the background in the camera's viewfinder and turn on the camera's meter to determine the proper shutter speed for the aperture you have set. Note that the shutter speed should be within the flash synchronization range for the camera you are using.
- 3) **Take the picture.** With the SB-16 set at A1 or A2 and turned on, take the picture *only if* a proper synchronization speed is available.

Notes:

- 1) *Exposure is more easily affected by the brightness of the background in the non-TTL automatic mode than it is in the TTL-automatic mode.*
- 2) *Because the usable apertures are limited in the non-TTL automatic mode, a proper shutter speed to match the shooting aperture may not be available.*

Synchronization with slow shutter speeds

If you are using the SB-16 at a high shutter speed under dim light, the background may come out too dark. To avoid this, use a slower shutter speed. The procedure for synchronization with slow shutter speeds is the same as that described before; however, you should mount the camera on a tripod to avoid camera shake at speeds of 1/30sec. and below. Also, it is recommended that you make the background somewhat underexposed.

Note: When using color film, especially transparency film, unnatural color casts may occur when the ratio of flash illumination to ambient light is low.



Fast synchronization speed: the background is too dark.



Slow synchronization speed: now details in the background can be seen.

Diffusing the Light

Light is what gives form to solid objects. If the flash is pointed directly at the subject and located near the lens, the subject will look flat because of the lack of shadows. However, if the flash is moved off-axis, shadows start to appear on the side opposite the light source, thus giving the impression of roundness. But because the light still comes directly from the flash, the shadows are harsh and unattractive. By diffusing the light, you can eliminate the harsh shadows, making snapshots and portraits much more attractive.

There are two ways to diffuse light: you can either bounce the light off a broad reflective surface, such as the ceiling or walls, or use a diffuser between flash and subject.

Bounce flash photography

With the SB-16's main flash head tilted back and/or rotated, the light travels directly to the ceiling or wall and then bounces back to the subject. Acting as a broad reflector, the ceiling or wall scrambles the direction of the light rays, making the lighting diffused and much more natural looking. Because the SB-16's secondary flash head faces straight ahead, it provides a small amount of direct illumination to fill in unflattering shadows around the eyes and creates a catchlight for the eyes.

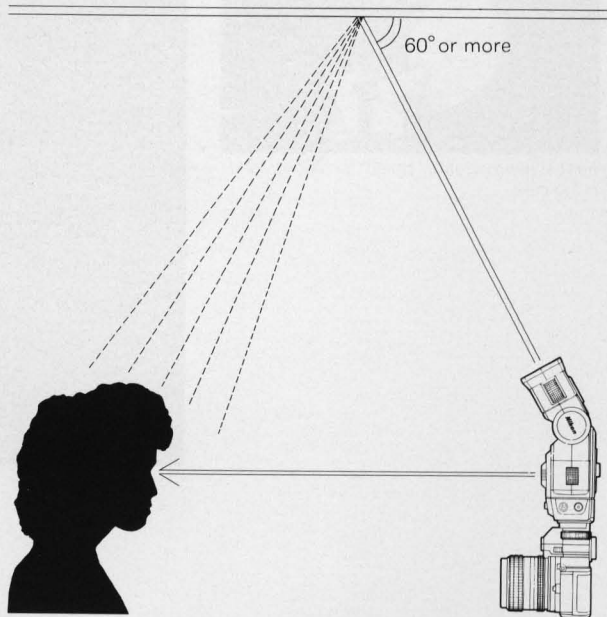



Direct flash: harsh, unflattering lighting.



Combination bounce and direct flash: soft, natural-looking lighting with a pleasing catchlight in the eyes.

PHOTOGRAPHIC TECHNIQUES—continued

The procedure for bounce flash is as follows:

1) Choose the bounce surface.

Select the ceiling or wall you want to bounce the flash off of; then tilt and/or rotate the main flash head so that it points in that direction. The position of the flash unit, the bounce angle, and the setting of the zoom head should be determined after considering the size and shape of the subject and the effect desired. With a subject having great depth, some light should reach the point furthest away from the camera to create a three-dimensional effect. For portraits, consider how much brightness you want for the background.

2) Set the zoom head.

In bounce flash photography, a large amount of light is required, because the light has to travel a longer distance than in direct flash photography, and also the bounce surface absorbs a certain amount of light. Therefore, it is recommended that the zoom head be set at T. The ratio of diffused illumination (from the bounce surface) to direct illumination (from the secondary flash head) is also an important consideration. If the bounce surface is too far away or is not very reflective, the level of the diffused illumination may be almost the same as the direct illumination, thus effectively cancelling the diffused lighting effect. In this case, adjust the angle of the main flash head or shorten the bounce distance so that there is more difference in illumination levels.

3) Choose an aperture.

Test firing the flash is necessary, because exposure in bounce flash photography depends on so many conditions, such as reflectivity of the bounce surface and the bounce distance. Note that, in bounce flash, shooting distance cannot be read with the exposure calculator dial.

4) Bracket your exposures.

It is recommended that you take additional shots, with the camera's exposure compensation dial set in the + direction for TTL automatic shooting or with the lens opened up one or two f/stops in the regular (non-TTL) automatic mode.

Notes:

- 1) *In general, there is a two or three f/stop loss in illumination because of the absorption of light by the reflective surface.*
- 2) *Unless the surface of the reflector you are bouncing the light off of is white or silver, your color photographs will come out with an unnatural color cast similar to that of the reflecting surface.*
- 3) *When the flash head is tilted back 45° or less, some amount of light from the flash head may reach the subject directly, causing unevenness of illumination. To avoid this, make sure the head is tilted back 60° or more.*
- 4) *In bounce flash, the angle of incidence is equal to the angle of reflection.*

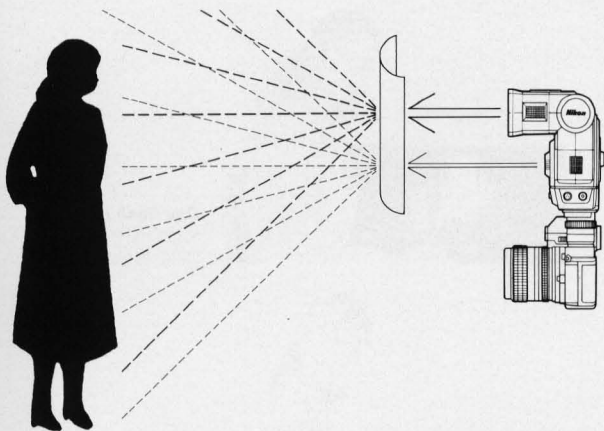

Using a diffuser

It is also possible to diffuse the light by placing a translucent material, such as one or more sheets of tracing paper, between the flash and subject. You can create more pronounced diffusion by placing a certain distance between the diffuser and flash than by wrapping the diffuser around the flash head. Experimentation with different flash-to-diffuser distances and/or with more than one diffuser is recommended.

Notes:

- 1) *In non-TTL automatic shooting, make sure that the diffuser does not come between the SB-16's sensor and the subject.*
- 2) *Some diffusion materials may cause a slight reddish tint in color photographs by decreasing the color temperature of the light from the flash.*
- 3) *When a diffuser is used, shooting distance cannot be read with the exposure calculator dial.*

Multiple Flash Photography

If you have another flash unit, you can use it as a secondary light source for multiple flash photography. When you use only one flash unit in front of a subject, harsh shadows may be produced or light may not reach the background. But by using more than one flash unit, you can solve these problems.

With the SB-16 and F3-series, FA, FE2, F-501/N2020, F-301/N2000, FG or Nikonos-V camera combination, both TTL and manual multiple flash photography are possible. In both cases, one important fact to remember is that the effect produced by using more than one flash unit depends on the lighting ratio or balance of illumination between flash units. So first you should determine the role of each flash unit, deciding which flash will be the main flash and which the secondary.

To create pictures with high contrast, give different exposure to the subject and background by adjusting the aperture, shutter speed and/or camera-and flash-to-subject distance.

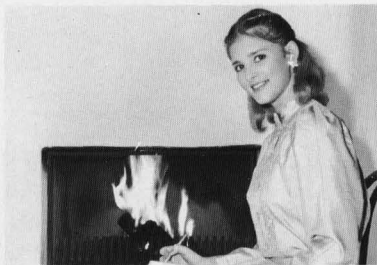

One flash unit:
standard, rather static lighting.



Two flash units:
dramatic lighting resembling window light.

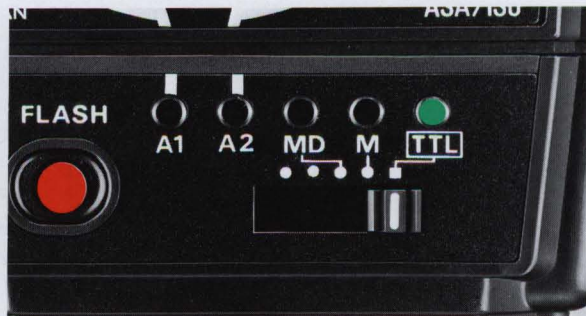

TTL multiple flash photography

By using the SB-16 connected to an F3-series, FA, FE2, F-501/N2020, F-301/N2000, FG or Nikonos-V (via V-Type Sync Cord) camera as a master flash unit and either the Nikon Speedlight SB-11, SB-14, SB-15, SB-16, SB17, SB-18 and/or SB-140 as slave flash unit(s), TTL multiple flash photography with up to five flash units can be performed.

To perform TTL multiple flash photography, use the optional TTL Multi-Flash Sync Cord SC-18 (1.5m) and/or SC-19 (3m) to connect the flash units together via the TTL multiple flash terminal.

To use the SB-11, SB-14 and/or SB-140 in TTL multiple flash photography, the TTL Remote Cord SC-23 is required.

PHOTOGRAPHIC TECHNIQUES—continued

SYSTEM CHART FOR TTL MULTIPLE FLASH OPERATION

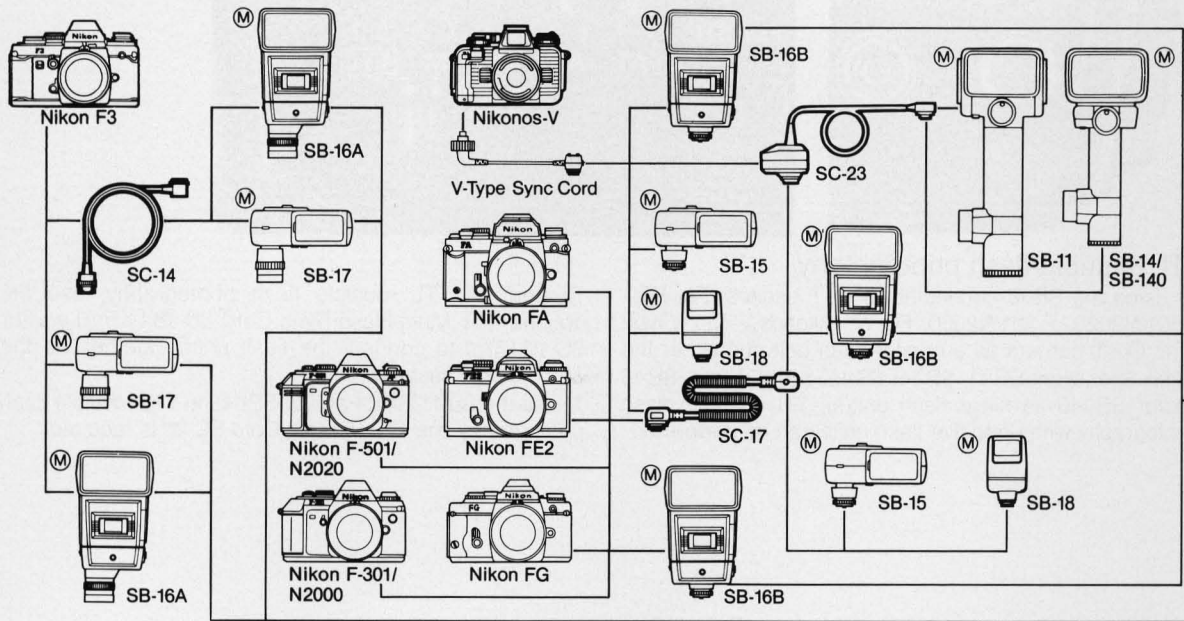

Ⓜ indicates the "master" flash unit.

*TTL multiple flash photography is possible only with an F3-series, FA, FE2, F-501/N2020, F-301/N2000, FG or Nikonos-V camera.

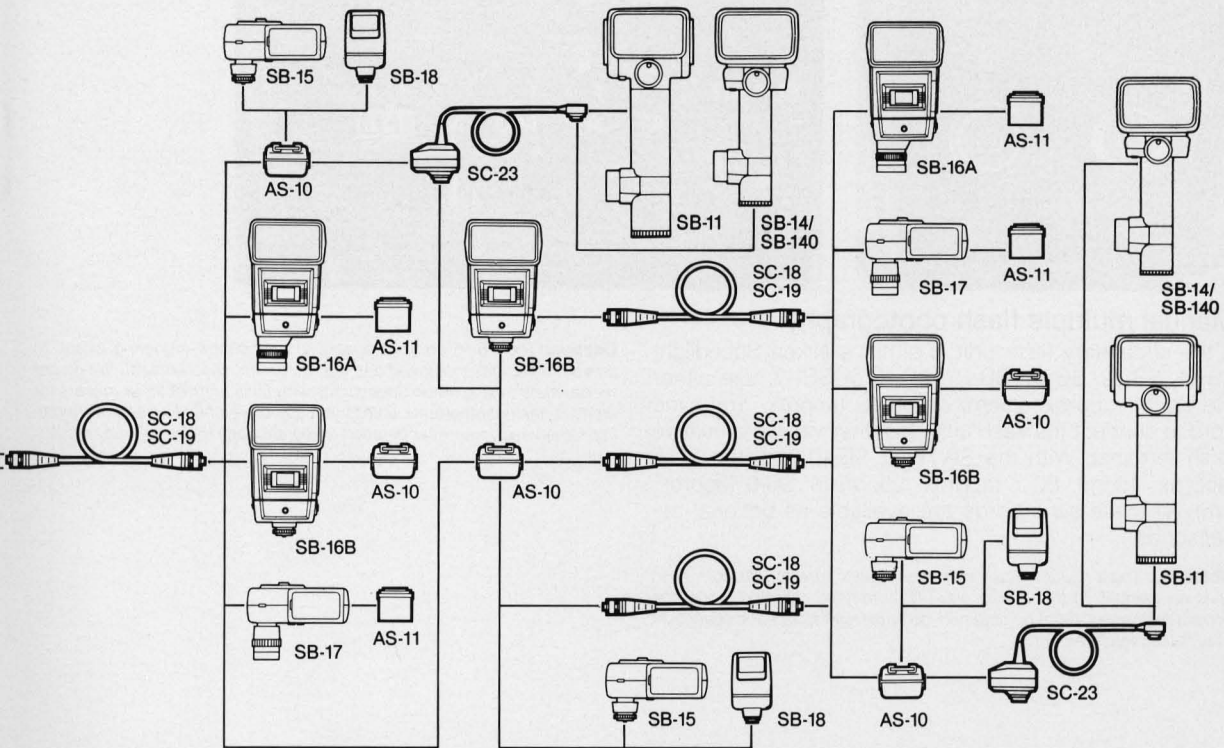

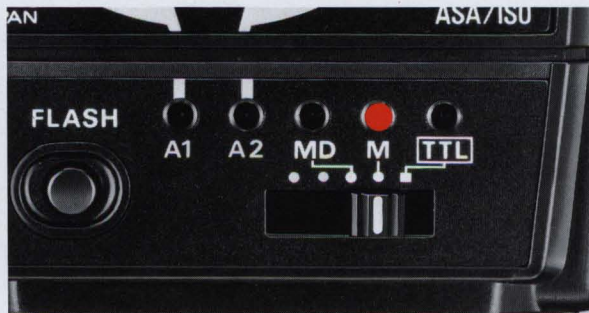

Manual multiple flash photography

If the secondary flash unit is either a Nikon Speedlight SB-11, SB-12, SB-14, SB-15, SB-16 or SB-17, use either the SC-11 (approx. 25cm) or SC-15 (approx. 1m) sync cord to connect the flash units together via sync/multiple flash terminal. With the SB-7E or SB-10, use the SC-5 (approx. 15cm), SC-7 (approx. 25cm) or SC-6 (approx. 1m). All these sync cords are available as optional accessories.

Note: In manual multiple flash operation, make sure to use both flash units on manual. In the TTL or non-TTL automatic shooting mode, the correct exposure cannot be obtained, because light from each speedlight affects the measurement.

Caution: The SB-16 employs a special low-voltage triggering circuit to prevent electrical shock and damage to the hot-shoe contact. We do not recommend mixing Nikon Speedlights with flash units of other makers for multiple flash photography, unless you use slave units for remote triggering. Otherwise, incorrect operation and/or damage to the unit may result.

ACCESSORIES

Sync Cords 10, 11, and 15

For use with cameras not provided with a hot shoe or for off-camera or multiple-flash lighting setups. The SC-11 is 25cm while the SC-15 is one meter. To use the SC-10 with F2- or F3-series cameras, use of the Nikon Flash Unit Coupler (AS-1 for the F2 and AS-4/7 for the F3) is required.

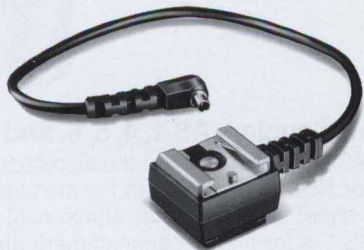

SC-10

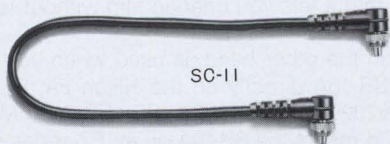

SC-11



SC-15

TTL Remote Cord SC-14

The SC-14 enables the SB-16A to be used up to one meter off a Nikon F3-series camera for TTL automatic flash operation.



TTL Remote Cord SC-17

The coiled cord SC-17 enables the SB-15, SB-16B or SB-18 to be used up to one and half meters off a Nikon FA, FE2, F-501/N2020, F-301/N2000, or FG camera for TTL automatic flash operation. Even with the SC-17, automatic sync speed setting and ready-light indication in the viewfinder are provided just as if the flash unit were mounted directly on the camera. The SC-17 which has two terminals for TTL multiple flash photography can be used to connect up to two slave flash units when the SB-16B is used as a master flash unit. A tripod socket is provided.

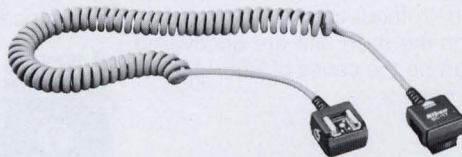

TTL Multi-Flash Sync Cords SC-18 and SC-19

The SC-18 and/or SC-19 are used to connect the flash units together for TTL multiple flash operation. The SC-18 is 1.5m long, while the SC-19 is 3m.



TTL Multi-Flash Adaptor AS-10

When you plan to perform TTL multiple flash operation with more than three flash units or to use the SB-15 or SB-18 as a slave flash unit, the AS-10 is required. With one AS-10 having three TTL multiple flash terminals, you can use up to three slave flash units including one mounted on it.

A tripod socket at the bottom enables the SB-16B mounted on the AS-10 to be fixed to a tripod. To perform TTL flash photography with two units using the SB-16B as a slave flash unit or to perform TTL photography with three units using the SB-16B as a master flash unit mounted on the SC-17, use of the AS-10 is not always needed. Without the AS-10, however, the electrical contacts on the flash unit are uncovered and can be the cause of incorrect output control.



Flash Tripod Adaptor AS-11

The AS-11 enables the SB-16A, used as a slave flash unit, to be attached to a tripod. Also, it prevents the SB-16A ready-light from blinking for no reason and lets you see when the flash is ready to fire and whether or not the flash fired at its maximum output.



Flash Unit Couplers AS-1, 4, 5, 6, and 7

The AS-1, AS-4, or AS-7 convert the accessory shoe of a Nikon F2- or F3-series camera to the standard ISO-type accessory shoe, allowing direct attachment of the SB-16B. The AS-1 is for the F2-series camera and the AS-4 and 7 are for the F3-series camera. A special feature of the AS-7 is that it lets you change film without removing the flash unit.

The AS-6, on the other hand, is used when you want to mount the SB-16A directly on the Nikon FA, FE2, FM2, FE, F-501/N2020, F-301/N2000, FG, FG-20, EM or FM camera. To mount the SB-16A on an F2-series camera, the AS-5 is required.



AS-1



AS-4



AS-5



AS-6



AS-7

Soft Flash Unit Case SS-16

The SS-16 accommodates the main flash unit of the SB-16 and both Flash Unit Couplers AS-8 and AS-9, one attached to the main flash unit, and one stored separately inside the pocket, with the Wide-Flash Adapter SW-7 attached to the flash head. If you do not store a flash unit coupler in the pocket, then you can put the SW-7 inside the pocket instead of attaching it to the flash head. The pocket can also be used to store spare batteries.

Note: In storing the coupler or adapter inside the pocket, never put them together or anything else with it. If you do so, the electrical contacts on the mounting foot of the coupler or the glass surface of the adapter may be damaged.



“Red eye” is a phenomenon in flash photography where the center portions of the subject’s eyes appear as bright red orbs in color photographs (or white in black and white pictures). This is a result of the light from the flash illuminating the retina directly. If the subject looks straight into the lens and there is little or no ambient light, the pupil is wide open, making the retina clearly visible in the picture.

To avoid “red eye,” you can take any or all of the following precautions:

1. Ask the subject not to look directly into the lens when the picture is taken.
2. Remove the flash unit from the camera and hold it as far away as possible from the camera by using a sync cord.
3. Increase the room’s overall illumination to reduce the opening of the subject’s pupils.

TIPS ON SPEEDLIGHT CARE



- To remove dirt or fingerprints, wipe with a dry soft or silicon-treated cloth. Never use thinner, benzene or alcohol, since they might damage the plastic parts. To clean the Wide-Flash Adapter, wash it with soap and water. Never use a brush, as this may damage it.

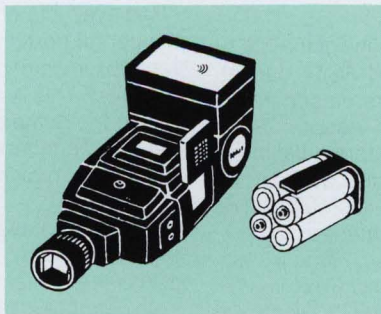

- If you do not plan to use the unit for more than two weeks, remove the batteries to avoid possible damage to the circuitry by battery leakage. If leakage should inadvertently occur, take the flash unit to your nearest Nikon authorized service facility.

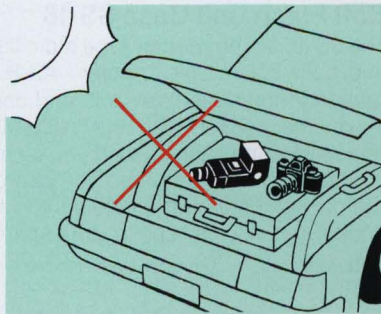

- To prevent damage to the flash unit's electronic circuitry, keep the camera away from places where the temperature is likely to go higher than 50°C, such as inside the trunk of a car in the hot summer sun; also do not store the unit in exceptionally damp places. Use the SB-16 within the range of -10°C~+50°C.

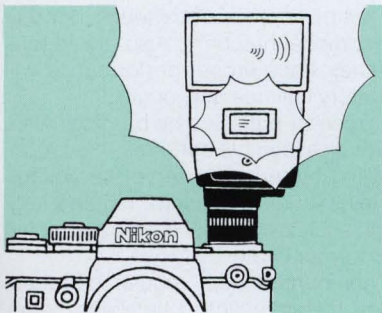

- If your SB-16 has not been used for a long time, its recycling time may be longer. To maintain the built-in condenser in peak condition, thereby enabling you to use the SB-16 for many years, fire the flash unit a few times every month. After firing, wait until the ready-light lights, then turn off the power switch, remove the batteries, and store the SB-16 in a suitable location. This will prevent the condenser from deteriorating.

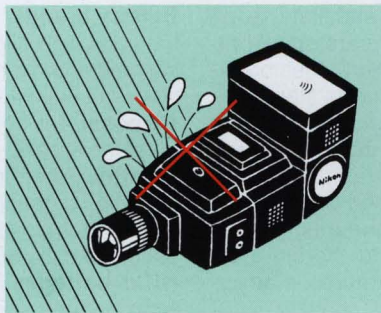

- Keep the flash unit away from salt water and out of the rain.

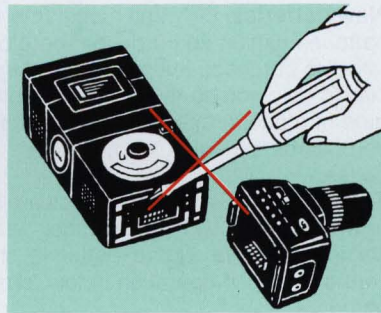

- Never attempt to disassemble or repair the flash yourself. These delicate procedures should be left to an authorized service facility.

OPTIMUM BATTERY PERFORMANCE

New batteries. Between manufacturing and first use, all batteries exhibit some drain. Therefore, care should be taken to purchase the newest (and freshest) ones possible. To help you do this, some manufacturers stamp the date of manufacture on the bottom of each battery. Ask your camera dealer for assistance in interpreting the codes.

Temperature. Battery life ratings are based on operation at around 25°C (77°F). At other temperatures, battery life is shortened. Spare batteries should therefore be kept available if operation in low temperatures is anticipated.

Continuous use. Batteries are drained much more quickly by continuous use than by intermittent use.

Storage. When not in use, the batteries should be removed to prevent damage from leakage. To minimize drain during the period of disuse, store the batteries in a cool, dry place below 20°C (68°F).

Battery brands. Do not mix brands of batteries, nor use batteries with different model numbers. Also, avoid mixing new and old batteries since proper performance will not be obtained and battery leakage may occur.

Disposal. Do not dispose of batteries by burning. Also, for safety's sake, never disassemble batteries.

Polarity. When installing batteries, observe the voltage polarities carefully. Reversal of the positive (+) and negative (-) terminals will result in leakage. If leakage should occur, take the SB-16 to your dealer.

NiCd batteries. In comparison with regular batteries, NiCd batteries provide faster recycling time and better efficiency at low temperatures. However, note that the recycling time and the number of flashes per battery set are dependent on the age of the batteries, how much charge they have, and their capacities.

SPECIFICATIONS

(The SB-16 main flash unit has the following specifications when combined with the Flash Unit Coupler AS-8 or AS-9)

Electronic construction

Automatic silicon-controlled rectifier and series circuitry
At full output: 32 (52) with the zoom head set at N; 19 (33) with the zoom head set at W₁ and Wide-Flash Adapter SW-7 attached

Guide number at ASA/ISO 100 and meters (or at ASA/ISO 25 and feet)

Angle of coverage

60° horizontal and 45° vertical with the zoom head set at N; 78° horizontal and 60° vertical with the zoom head set at W₁ and Wide-Flash Adapter attached

Flash heads

Two flash heads provided; main head tilts back 90° with click-stops at the 30°, 45°, 60°, 75° and 90° positions and also rotates through an arc of 270°, 90° clockwise with click stops at 30°, 60° and 90° positions, and 180° counterclockwise with click-stops at 30°, 60°, 90°, 120°, 150° and 180° positions; the smaller secondary head faces straight ahead to provide a catch-light for the eyes

Zooming capability

Possible with four settings (T, S, N and W₁ for 85mm, 50mm, 35mm and 28mm lens

Batteries

Four 1.5V AA-type alkaline-manganese penlight batteries or four 1.2V AA-type NiCd batteries recommended

Number of flashes and recycling time

(on manual at 25°C)

Battery type	Number of flashes*	Recycling time*
Alkaline-manganese	approx. 100 times	approx. 11 sec. minimum
NiCd**	approx. 40 times	approx. 8 sec. minimum

* At full output; of course, more flashes and shorter recycling times are possible in the TTL, non-TTL automatic, or MD mode

** This data depends on brand of battery and amount of recharging

TTL auto exposure

Through-the-lens automatic exposure control when the SB-16A is combined with the Nikon F3-series camera or when the SB-16B is combined with the Nikon FA, FE2, F-501/N2020, F-301/N2000, FG or Nikonos-V; film speeds from ASA/ISO 25 to 400 with the FA, FE2, FG or Nikonos-V, or ASA/ISO 25 to 1000 with F-501/N2020 or F-301/N2000; usable aperture range from f/2 to f/22

Non-TTL auto exposure

Automatic exposure control via the front-mounted light sensor; two working apertures depending on film speed (f/8 and f/4 at ASA/ISO 100) are usable and identified as A1 and A2

SPECIFICATIONS—continued

Manual exposure control	Full output at M setting
Synchronization with motor driven camera	Possible at MD setting with 1/16th of full output; guide number is 8 at ASA/ISO 100 and meters (or 13 at ASA/ISO 25 and feet) with the zoom head set at N; only main flash fires
Dimensions (W × H × D)	
SB-16A	approx. 82 mm × 166.5 mm × 100 mm
SB-16B	approx. 82 mm × 144 mm × 100 mm
Weight	
SB-16A	approx. 485 g (without batteries)
SB-16B	approx. 445 g (without batteries)
Accessories provided	Wide-Flash Adapter SW-7; Soft Case SS-16; Battery Holder MS-5

Specifications and designs shown herein are subject to change without notice.

1952

WINDSOR FOREVER

1952



No reproduction in any form of this manual, in whole or in part (except for brief quotation in critical articles or reviews), may be made without written authorization from Nippon Kogaku K.K.

NIPPON KOGAKU K.K.

Fuji Bldg., 2-3, Marunouchi 3-chome, Chiyoda-ku, Tokyo 100, Japan
Phone: 81-3-214-5311 **Telex:** J22601 (NIKON) **Fax:** 81-3-201-5856

Printed in Japan 8&137-E06