

***Nikon***

**N90**

**AF**

INSTRUCTION MANUAL

**E**

# CONTENTS

<b>FOREWORD</b> .....	4
<b>NOMENCLATURE</b> .....	5-10
<b>BASIC OPERATION</b> .....	11-26
MOUNTING THE LENS.....	12
INSTALLING BATTERIES.....	13
CHECKING BATTERY POWER.....	14-15
LOADING FILM.....	16-18
BASIC SHOOTING.....	19-24
REWINDING FILM.....	25-26
<b>GENERAL FUNCTIONS</b> .....	27-66
<b>FILM ADVANCE MODE</b> .....	28-29
SINGLE-FRAME SHOOTING.....	28
CONTINUOUS SHOOTING.....	29
<b>EXPOSURE METERING SYSTEM</b> .....	30-32
MATRIX METERING.....	30
CENTER-WEIGHTED METERING.....	31
SPOT METERING.....	31
SETTING METERING SYSTEM.....	32
<b>FOCUS</b> .....	33-48
FOCUS AREA.....	33-35
AUTOFOCUS.....	35-39
AUTOFOCUS WITH MAIN SUBJECT OFF CENTER.....	40-43
SPECIAL FOCUSING SITUATIONS.....	44-45
MANUAL FOCUS.....	46-48
<b>EXPOSURE MODE</b> .....	49-66
SELECTING EXPOSURE MODE.....	50-53
SETTING EXPOSURE MODE.....	54
FLEXIBLE PROGRAM.....	55
OPERATION IN SHUTTER-PRIORITY AUTO EXPOSURE MODE.....	56-59
OPERATION IN APERTURE-PRIORITY AUTO EXPOSURE MODE.....	60-62
OPERATION IN MANUAL EXPOSURE MODE.....	63-66
<b>VARI-PROGRAM</b> .....	67-85
<b>WHAT IS VARI-PROGRAM?</b> .....	68-69
<b>SELECTING VARI-PROGRAM SOFTWARE</b> .....	70-71
<b>SHOOTING WITH VARI-PROGRAM</b> .....	72-85
PORTRAIT PROGRAM.....	72-73
PORTRAIT PROGRAM WITH RED-EYE REDUCTION (with SB-25 Speedlight exclusively).....	74-75
HYPERFOCAL PROGRAM.....	76-77
LANDSCAPE PROGRAM.....	78-79
SILHOUETTE PROGRAM.....	80-81
SPORT PROGRAM.....	82-83
CLOSE-UP PROGRAM.....	84-85
<b>SPECIAL FUNCTIONS</b> .....	86-102
<b>EXPOSURE COMPENSATION</b> .....	87-93
AE-L (AUTO EXPOSURE LOCK) LEVER.....	88-89
TO OBTAIN METER READING FOR A PARTICULAR SUBJECT IN MANUAL EXPOSURE MODE.....	90-91
EXPOSURE COMPENSATION BUTTON.....	92-93
<b>SELF-TIMER OPERATION</b> .....	94-96
ONE-SHOT SELF-TIMER.....	95
TWO-SHOT SELF-TIMER.....	96
<b>TO CONFIRM SHARPNESS BEFORE SHOOTING</b> —DEPTH-OF-FIELD PREVIEW BUTTON.....	97

LONG TIME EXPOSURE—Using <b>bulb</b> setting .....	98-99	(for use with SB-25 only) .....	124-125
TO USE NON-DX-CODED FILM .....	100	NOTES ON FLASH PHOTOGRAPHY .....	126
INTERCHANGING FOCUSING SCREENS .....	101-102	EV CHART FOR FLASH PHOTOGRAPHY .....	127
<b>LENSES</b> .....	103-106	<b>MISCELLANEOUS</b> .....	128-147
LENS COMPATIBILITY CHART .....	104-106	ACCESSORY COMPATIBILITY .....	129
<b>FLASH PHOTOGRAPHY</b> .....	107-126	CAMERA CARE TIPS .....	130-132
<b>NIKON SPEEDLIGHT COMPATIBILITY</b> .....	108-109	NOTES ON BATTERIES .....	132-133
FLASH MODES AVAILABLE		SPECIFICATIONS .....	134-138
WITH NIKON SPEEDLIGHT .....	108	GLOSSARY .....	139-142
WHAT YOU CAN DO		LCD PANEL/VIEWFINDER INDICATIONS .....	143-147
WITH YOUR NIKON SPEEDLIGHT .....	109		
<b>TTL AUTO FLASH—AUTOMATIC BALANCED</b>			
<b>FILL-FLASH AND STANDARD TTL FLASH</b> .....	110-119		
TYPE OF TTL AUTO FLASH .....	110-113		
AUTOMATIC BALANCED FILL-FLASH			
WITH TTL MULTI SENSOR—3D MULTI-SENSOR			
BALANCED FILL-FLASH AND MULTI-SENSOR			
BALANCED FILL-FLASH .....	114		
CENTER-WEIGHTED/SPOT FILL-FLASH .....	115		
STANDARD TTL FLASH .....	115		
SHUTTER SPEED/APERTURE FOR EACH EXPOSURE			
MODE IN TTL AUTO FLASH .....	116-117		
TTL AUTO FLASH OPERATION .....	118-119		
<b>TO MAKE NIGHT BACKGROUND MORE VISIBLE</b>			
—SLOW SYNC OPERATION .....	120-121		
<b>TO CREATE NATURAL-LOOKING STREAM OF LIGHT</b>			
—REAR-CURTAIN SYNC .....	122-123		
<b>RED-EYE REDUCTION</b>			

# FOREWORD

Thank you for choosing the new Nikon N90 camera. It's a high-performance camera that offers today's newest and most advanced capabilities, all designed to enable you to take more exciting pictures.

Because the N90 camera has a host of new features, many of which you may not be familiar with, before actually taking pictures you should thoroughly read the instruction manuals provided, including the "PHOTOGRAPHIC SYSTEM" leaflet. These will help you understand the technical terminology used and how the various new features work.

The N90, in its standard configuration, is a powerful camera with important features such as Nikon's exclusive Advanced Matrix Meter, many autofocus features including Focus Tracking, and Nikon's latest innovation, TTL Multi-Sensor flash control. To expand the camera's performance and take full advantage of all its capabilities, you will want to consider using the N90 with accessories such as the Nikon MF-26 Multi-Control Back, the Nikon SB-25 AF Speedlight, and the Nikon Data Link System with IC Card AC-1E which works exclusively with the Sharp® Electronic Organizer.

Please read this manual thoroughly, then enjoy experimenting with all of the N90's exciting features. Good luck, and have a great time with this high-tech Nikon.

Sharp is a registered trademark of SHARP CORPORATION.



# NOMENCLATURE

Once you know the names of the parts of your new Nikon N90, as well as their functions and the camera's other controls, you will be surprised how simple and logical the N90 system's operation can be.

LCD panel (p. 9)

**Shutter release button:** To activate exposure meter and autofocus function, lightly press; to release shutter, depress fully; exposure meter automatically switches off after 8 sec.

**Self-timer indicator LED**  
(pp. 95-96)

**Depth-of-field preview button**  
(p. 97)

**AF-L (Auto Focus Lock) button:** Locks focus when pressed and held in.

**Minimum aperture lock:** Setting for all Programmed and Shutter-Priority auto exposure modes.

Aperture scale

**Accessory shoe:** For Nikon dedicated Speedlights. The rear edge of the shoe indicates film plane. Exact distance from lens mounting flange to film plane is 46.5mm.

Sync terminal

**10-pin remote terminal:** For Electronic Organizer Connecting Cord MC-27, Remote Cord MC-20, etc. (see attached PHOTOGRAPHIC SYSTEM leaflet).

Lens release button

**Focus mode selector:**  
**S** for Single Servo AF (pp. 36-37).  
**C** for Continuous Servo AF (pp. 38-39).  
**M** for Manual focus (pp. 46-48).

Lens mounting index

Focusing ring

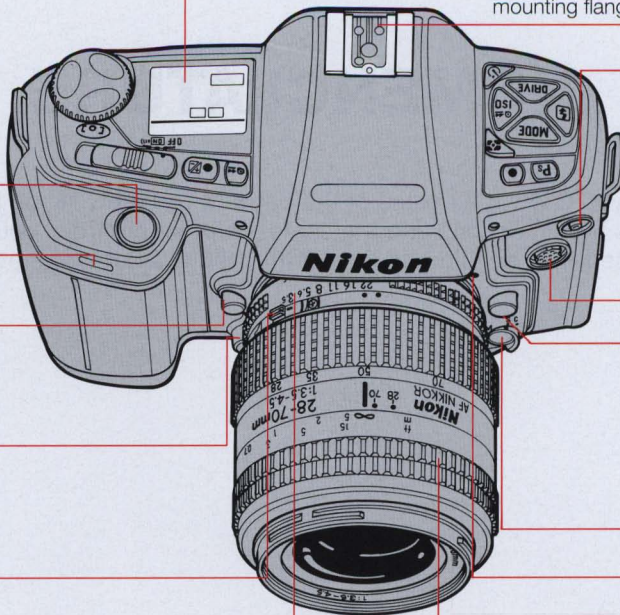

Optional lens illustrated  
(AF Zoom-Nikkor 28-70mm f/3.5-4.5 D)

**Eyepiece shutter lever:** Used to prevent stray light from entering viewfinder.

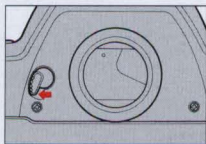

**Viewfinder/LCD panel illumination button:**

Press to illuminate viewfinder and LCD panel, useful in dim light. Illumination automatically switches off 8 sec. after you remove your finger from button.

**Camera strap eyelet**

**Camera back lock releases:** To open camera back, slide camera back lock releases together.

**Film cartridge confirmation window**

**Viewfinder eyepiece**

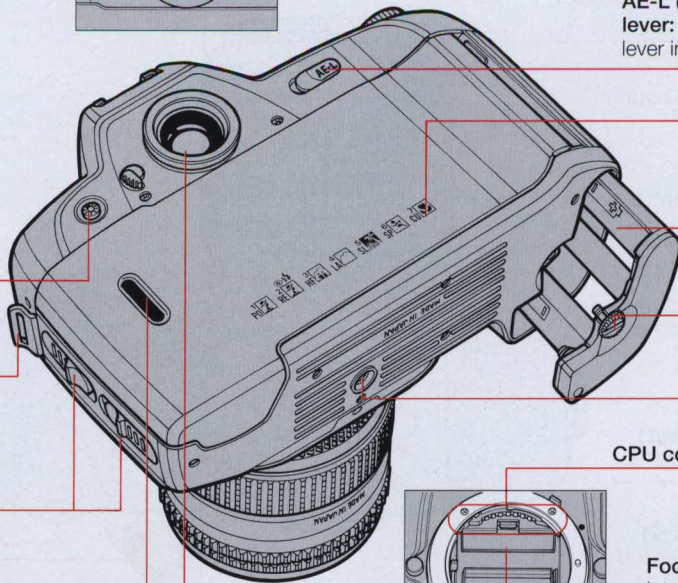

**AE-L (Auto Exposure Lock) lever:** Sliding and holding lever in locks auto exposure.

**Vari-Program list**

**Battery holder MS-8**

**Battery holder lock screw**

**Tripod socket**

**CPU contacts:** Don't touch!

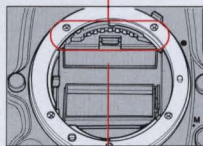

**Focusing screen type B:** Interchangeable with optional type E screen (pp. 101-102).



**Reset button:** Press and hold this button and exposure compensation/reset button together for instant reset of basic camera settings (p. 20)

**Exposure mode (MODE) button\*:** See page 54.

**Vari-Program (Ps) button\*:** See pages 70-71.

**Flash sync mode (⚡) button\*:** See pages 121, 123 and 125 .

**Film advance mode (DRIVE) button\*:** See pages 28-29

**Film speed/film rewind (1/125) button:** See pages 18, 25 and 100.

\* Used with command dial

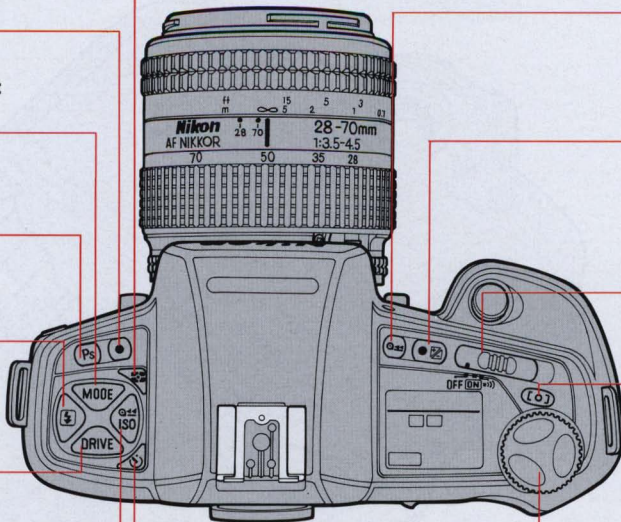

**Metering system (☉) button\*:** See page 32.

**Film rewind button**

**Exposure compensation/reset button (●/☒)\*:** See pages 20 and 92.

**Power switch: (⏻) setting** activates electronic beeper (pp. 14-15).

**Focus area button:** See page 33.

**Command input control dial (Command dial):** Rotate to set various functions.

**Self-timer button (⏸)\*:** See page 95-96.

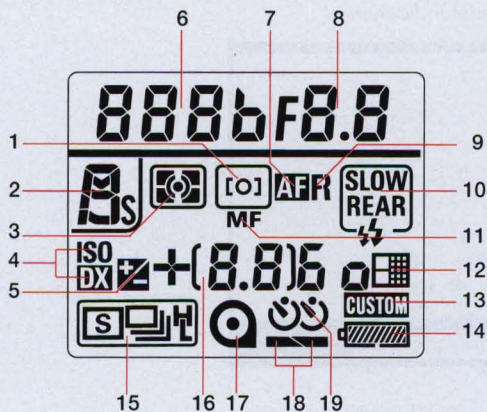

## LCD panel indications

- |                                       |   |
|---------------------------------------|---|
| 1. Focus area                         | 12. Electronic Organizer*   |
| 2. Exposure mode                      | 13. Custom*   |
| 3. Metering system                    | 14. Battery   |
| 4. Film speed setting mode            | 15. Film advance mode   |
| 5. Exposure compensation              | 16. Frame counter/Vari-Program/ISO speed/Self-timer duration/compensation value |
| 6. Shutter speed                      | 17. Film loading  |
| 7. Autofocus                          | 18. Film advance and rewind   |
| 8. Aperture                           | 19. Self-timer  |
| 9. Release/Focus priority             |   |
| 10. Flash sync mode/Red-Eye Reduction |   |
| 11. Manual focus                      |   |

*\*Appears only when Data Link System is in use.*

## Viewfinder indication

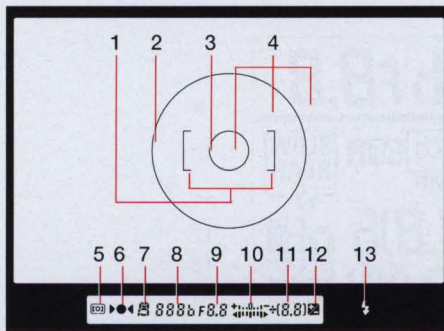

1. Wide-Area focus brackets
2. 12mm-dia. reference circle for Center-Weighted Metering
3. 3mm dia. reference circle for Spot Metering/Spot-Area focus
4. Clear matte field
5. Focus area
6. Focus indicators: ● indicates a stationary subject is in focus; ●◀ indicates a moving subject is in focus; ▶◀ shows Focus Tracking; blinking ▶◀ indicates autofocus is impossible; ▶ and ◀ arrows indicate front and rear focus, respectively.
7. Exposure mode
8. Shutter speed
9. Aperture
10. Electronic analog display
11. Frame counter/Vari-Program/compensation value
12. Exposure compensation
13. Flash recommend/ready light

Lightly pressing the shutter release button to turn on the exposure meter switches on the viewfinder illuminator at a low light level. In dim light, when the exposure meter is on, the illuminator automatically switches on at full brightness.

# **BASIC OPERATION**

This section shows you how to prepare the camera for shooting—e.g., how to mount lens, load film, etc.—as well as how to actually take pictures. Whether you're a beginner or a seasoned photographer, you should master this section before proceeding further.



# MOUNTING THE LENS

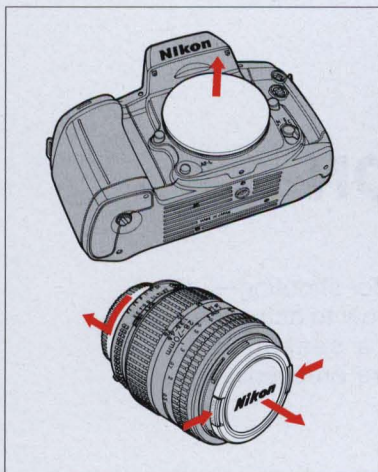

- 1 Remove camera body cap and front and rear lens caps.

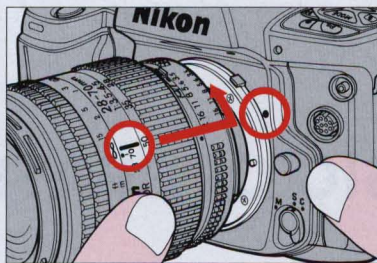

- 2 Position the lens in the camera's bayonet mount so that the mounting indexes on lens and camera body are aligned. Taking care not to press the lens release button, twist lens counterclockwise until it locks into place.

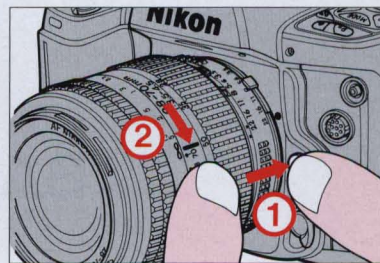

- To remove  
Push and hold lens release button and turn lens clockwise.

- When mounting/removing lens, make sure that the camera's power is turned off and avoid direct sunlight.
- See page 104 for Nikon lens compatibility chart.

# INSTALLING BATTERIES

- Make sure the power switch is set at OFF position.
- NiCd batteries that have "+" terminals exceeding 6mm in diameter cannot be used.
- Manganese batteries are not recommended for use at low temperatures.
- See page 133 for "NOTES ON BATTERIES."

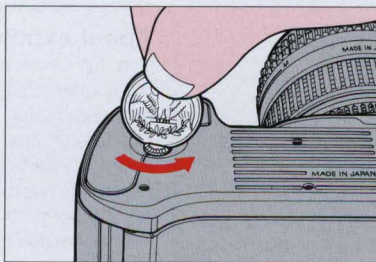

- 1 Loosen battery holder lock screw with a coin or similar object.

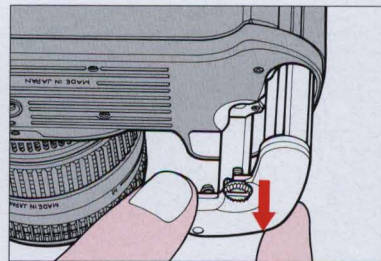

- 2 Remove battery holder.

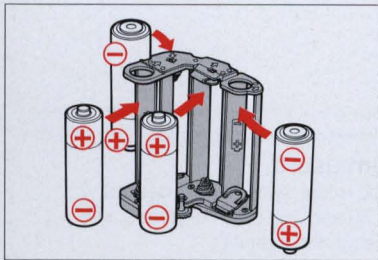

- 3 Install four AA-type alkaline-manganese, NiCd or high-performance manganese batteries with "+" and "-" terminals positioned as shown inside holder.

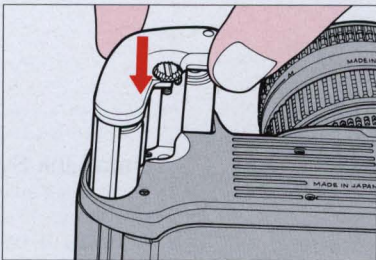

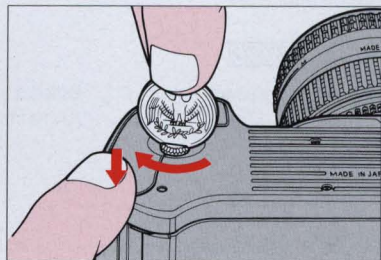

- 4 Return battery holder to battery chamber.

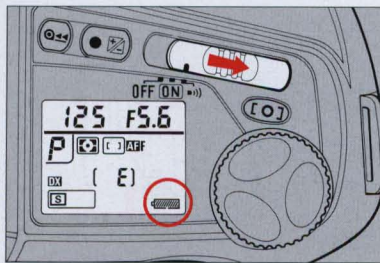

- 5 Press holder into place as you tighten lock screw with coin.

## CHECKING BATTERY POWER



Slide power switch to ON or  position, and confirm that a full battery mark appears on LCD panel, indicating sufficient battery power. The battery mark and exposure indications automatically turn off after 8 sec.



Sufficient battery power.



Batteries are nearing exhaustion.  
Have a fresh set ready.



If  blinks with/without blinking **Err**, batteries are just about exhausted. Slide power switch to OFF and replace batteries with a fresh set.

If no indication/mark appears, batteries are completely exhausted or improperly installed. Replace.

### About exposure meter

You can check battery power anytime by lightly pressing the shutter release button. This action activates the exposure meter; the LCD panel and viewfinder LCD show aperture/shutter speed indications, and autofocus operation starts (unless camera is set for manual focusing). The exposure indications and battery mark stay on for approx. 8 sec. after you take your finger off the shutter release button, then automatically turn off. If the shutter is released, these LCD readouts go off approx. 2 sec. after you take your finger off the button.

### Data Link System users

You can set automatic meter switch-off as desired: 4 sec., 8 sec., 16 sec., 30 sec., 60 sec. For details, see Nikon AC-1E card instruction manual.



## About electronic beeper

With the power switch set to **■||**, the beeper is on. Two types of sound are emitted: a double-beep which indicates in-focus position, and continuous beeping which is either an operation signal or an alert.

### Double-beep

A double-beep is emitted when a stationary subject becomes in-focus in the Single Servo AF mode\*.

### Continuous beeping sound indicates:

(As an operation signal)

- Film rewind is complete.
- Self-timer is activated (pp. 95-96).

(As an alert signal)

- Possible picture blur due to slow shutter speed in Programmed or Aperture-Priority Auto exposure mode.
- Possible over- or underexposure (with **H !** or **L a** indications) in auto exposure mode\*.
- Lens aperture is not set to the minimum setting in Programmed or Shutter-Priority auto exposure mode\*.
- Film reaches the end of the roll and requires rewinding\*.

\* Sounds when the shutter release button is lightly pressed.

- You have loaded a non-DX film or film with a damaged or unacceptable DX code for auto DX setting.
- Camera detects an abnormality such as torn or damaged film during film advance.
- Vari-Program is set with non-CPU lenses.
- Shutter-Priority Auto exposure mode is set with Bulb setting.
- Bulb setting is selected for Automatic Exposure Bracketing function of MF-26.
- Speedlight is not set to TTL flash mode with Auto Multi-Program.

## Data Link System users

You can use the Electronic Organizer to cancel the double-beep alert for in-focus and/or the continuous beep for picture blur alert.

The beeper also comes on when the camera's computer memory is full in the Memo Holder function.

For details, refer to Nikon AC-1E card instruction manual.

# LOADING FILM

- To avoid fogging film (especially high-ISO film), do not load/unload film in direct sunlight.
- Usable film speed range for DX-coded film is ISO 25 to 5000.
- For non-DX coded film, see p. 100.

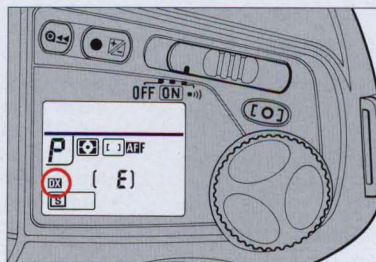

- 1 Confirm whether **DX** for DX-coded film is shown on the LCD panel.

## Data Link System users

You can set the camera to DX-priority. For details, see AC-1E card instruction manual.

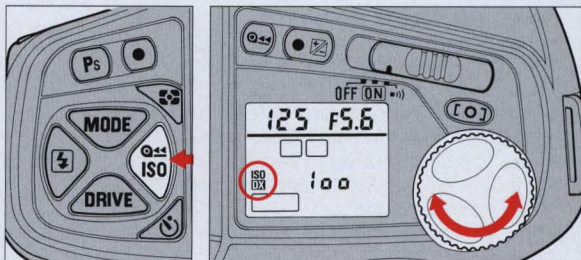

If not, press and hold ISO button in, then rotate command dial until **DX** appears.

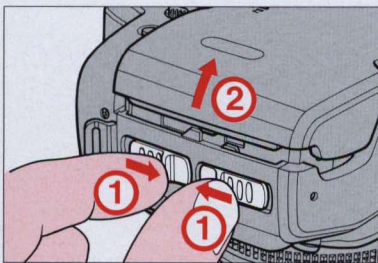

2 Slide camera back lock releases together to open camera back.

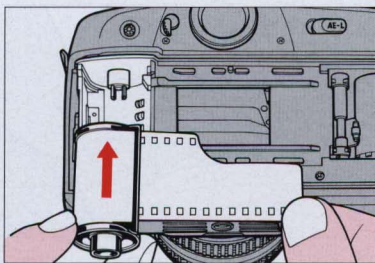

3 Insert film cartridge.

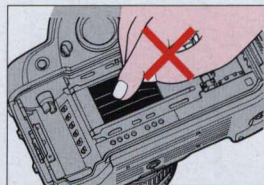

Do not touch the shutter curtains with your finger or with film leader.

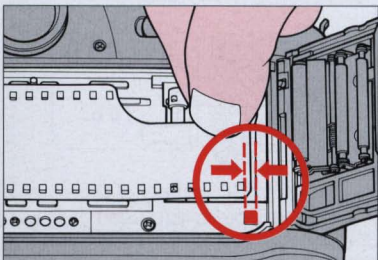

4 Pull film leader out to red index mark.

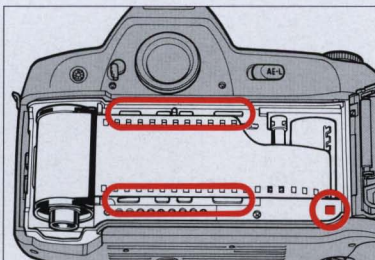

5 Check to ensure film is properly positioned with no slack (see illustration).

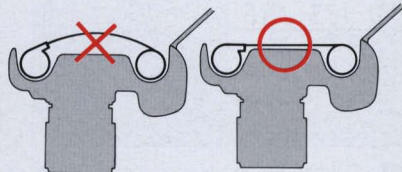



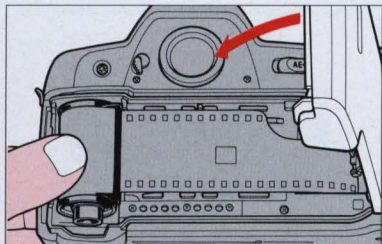

6 Gently close camera back until lock releases snap closed.

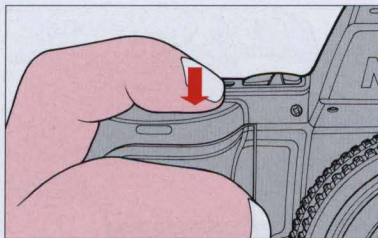

7 Fully depress shutter release button to advance film to frame #1.

- If non-DX-coded film or film with an unacceptable DX code is loaded, the **Err**, **ISO** and **DX** marks in the LCD

panel blink, the beeper sounds (if set), and the shutter is locked. Set ISO speed manually (see p. 100).

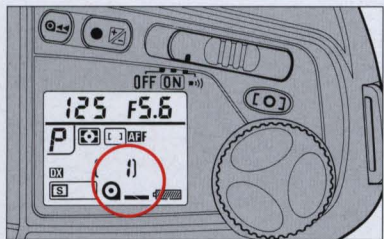

8 Confirm frame counter shows **1** and **i** symbol appears on LCD panel.

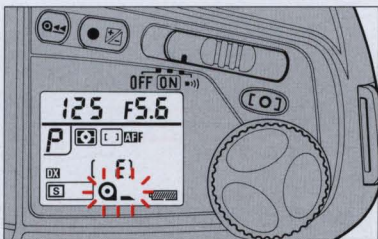

- If film is incorrectly positioned, **E** remains, **i** symbol blinks and shutter is locked. Open camera back and reload film properly.

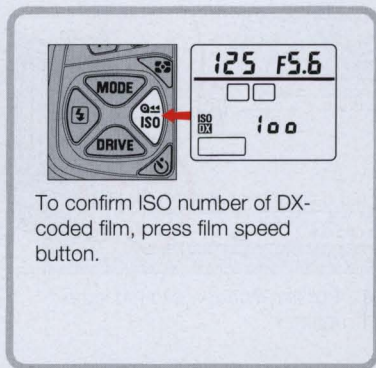

To confirm ISO number of DX-coded film, press film speed button.



# BASIC SHOOTING

This section features the settings for most common picture-taking situations when AF Nikkor\* lenses are used:

Film advance mode: single-frame shooting

Metering: Advanced Matrix Metering

Focus Area: Wide

Focus mode: Single Servo AF

Exposure mode: Auto Multi-Program

(If you are using AI-P-Nikkor lens, use manual focus [see pp. 46-48]. If you are using other non-AF Nikkor lenses, use Center-Weighted or Spot Metering [see p. 32], manual focus, and Aperture-Priority Auto or Manual Exposure mode [see pp. 60-62 or 63-66]. To confirm usable mode by lens, see chart on p. 104.)

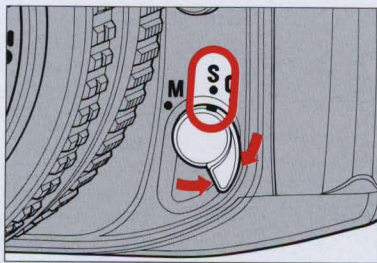

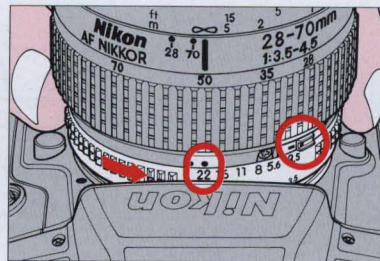

**1** Set focus mode selector to **S** for Single Servo autofocus. If lens has an A-M switch, set switch to A. If you are using an AF-I Nikkor lens, set the lens focus mode ring to A or M/A.



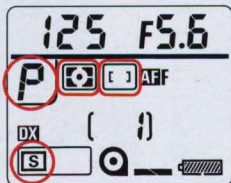
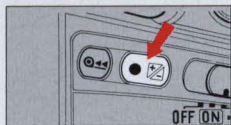
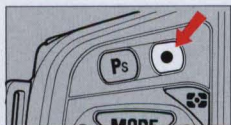

**2** Set lens to its minimum aperture (highest f-number marked in orange on AF Nikkor lenses) and lock lens aperture of AF Nikkor lens at its minimum setting (see lens instruction manual).

\* AF Nikkor lenses includes D-type AF Nikkor lenses and AF-I Nikkor lenses.



3 Press ● reset button and ●/☒ button simultaneously for two seconds until **P**, , **S** and  appear in the LCD panel, indicating that the camera settings are automatically reset for basic shooting shown here:

Film advance:	Single frame ( <b>S</b> )
Metering system:	Matrix (  )
Exposure control:	Auto-Multi Program ( <b>P</b> )
Focus area:	Wide (  )
Flexible program setting:	Cancel
Exposure compensation:	±0
Flash sync mode:	Normal (If Speedlight is set at rear-curtain sync, rear-curtain sync will be performed.)

## Data Link System users

When activating Custom Reset with the Nikon AC-1E card's Customized Settings function, press and hold the ● and ●/☒ buttons for two seconds to retrieve the Custom Reset settings.

When one or more functions/options (including Custom Reset) of the Customized Settings have been set, **CUSTOM** appears in the camera's LCD panel\*. To cancel the functions/options of the Customized Settings and reset your camera to the default setting (which will make **CUSTOM** disappear from the LCD), press and hold the ● and ●/☒ buttons for more than four seconds until **CUSTOM** starts blinking; then remove your fingers from the reset buttons and press them again within two seconds. (**CUSTOM** stops blinking when the reset buttons are left untouched for two seconds.)

**CUSTOM** also appears when "Store shooting data" is selected and/or "Download stored data" is likewise selected in the Memo Holder function. In this case, you also can make **CUSTOM** disappear from the LCD by following the instructions given above.

\* When Custom Reset and/or "Simultaneous Lock of AF and AE" of User Custom Option is set with the MF-26 attached to the camera, **CUSTOM** does not appear. To cancel Custom Reset or "Simultaneous Lock of AF and AE" with the MF-26, use the MF-26's  button and the camera's command dial. (For details, see the MF-26's instruction manual.)

### MF-26 users

Pressing the reset buttons also cancels the MF-26's following functions:

- Auto Exposure Bracketing
- Multiple Exposure Operation
- Auto Sequence Shooting
- Long Time Exposure
- Interval Timer
- Flash Exposure Bracketing
- Flash output level compensation
- Focus Priority

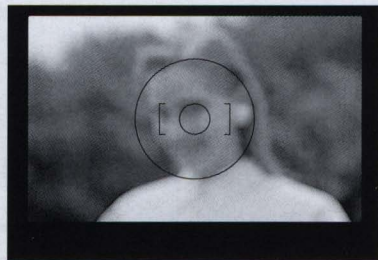

- 4 Hold camera, look through viewfinder and position focus brackets on main subject.

### With Nikon Autofocus Speedlight SB-25

Pressing the reset buttons also resets the Speedlight's flash output compensation to 0.

Although the viewfinder covers approx. 92% of the image area of the actual photograph, a negative film will show you an image larger than what you see through the viewfinder.

Note: The image in a slide film may be partially cropped by the mount. Also, the edges of negative film are partially cropped by most labs.



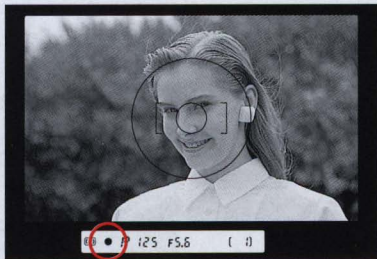
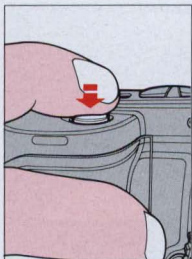

**5** Lightly press shutter release button to start autofocus operation and switch exposure meter on. Confirm that the in-focus indicator ● for a *stationary* subject or ►●◄ for a *moving* subject appears on the viewfinder's LCD readout. Confirm, too, that the shutter speed and aperture indications are shown. Exposure readouts also appear in the camera's external LCD panel.

In the Single Servo autofocus mode with Focus-Priority, the shutter cannot be released until ● or ►●◄ appears, indicating that the subject is in focus; the focus is then subsequently locked. If the distance between you and the subject changes, remove your finger from the shutter release button, then lightly press it again to refocus.

- In-focus indication for stationary subject
- ◄ Focus Tracking (automatically activates)
- ◄ In-focus indication for moving subject
  - ◄ Subject is located closer than the lens' closest focusing distance. Move away from the subject and refocus.
- Appears when TC-16A is used, alerting that the lens focusing ring is not set at infinity ( $\infty$ ). See p. 36.
- ◄ (with red dashed lines) If ►◄ blinks in the viewfinder: Autofocus is not possible (p. 44).

If shutter speed indicated is 1/(lens focal length) sec. or slower, the picture may come out blurred. To avoid this, hold camera firmly or use a tripod.

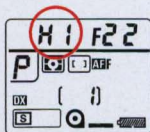

If **HI** appears in the shutter speed position—**Overexposure alert**: Use Nikon ND or similar filter.

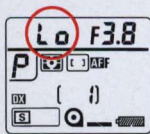
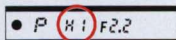

If **LO** appears in the shutter speed position—**Underexposure alert**: Use a Nikon Speedlight, higher ISO film or lens with faster aperture, whichever is suitable.

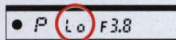

If **FEE** blinks in the aperture position—**Lens setting error alert**: Lens is not set to smallest aperture setting, so shutter is locked. Set lens to smallest aperture.



If **⚡** mark in green appears—**Flash-photography recommended**: If available light is insufficient, **⚡** mark appears. Use Nikon TTL-type Speedlight.

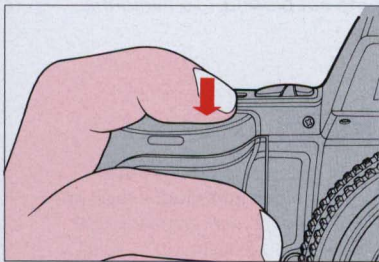



- 6** To take picture, fully depress shutter release button. Camera automatically advances film by one frame, and LCD frame counter increases by one.

Shutter speed/aperture indications in LCD panel and inside viewfinder turn off approx. 2 sec. after you release shutter and take your finger off shutter release button.



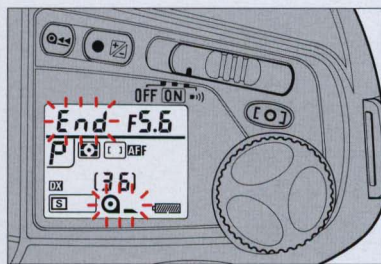



# REWINDING FILM

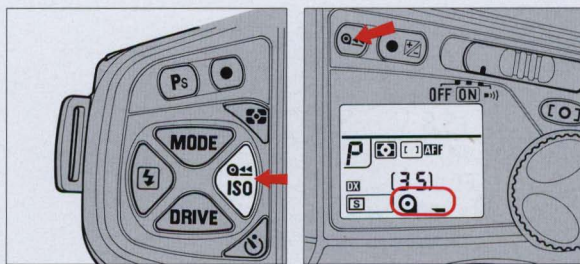



- 1 Film advance stops automatically at end of roll with **End** and  symbol in LCD panel blinking. (Audible beeper sounds if set.)
- At the end of film roll, each time you press shutter release button, **End** and  blink and audible beeper sounds (if set), reminding you to rewind film.



- 2 Press  button and  button to start film rewind. During film rewind,  appears on LCD panel, and frame counter counts backwards until rewind is complete.
- You can rewind film, before it reaches end of roll, in the same manner.
  - If film does not start rewind or if film rewind has stopped at mid-roll, check battery power. If battery power is insufficient, turn power switch off, replace batteries with a fresh set, turn power on, then press the film rewind and film speed setting/film rewind buttons again to restart film rewind.
  - Do not open the camera back during film rewind. If the camera back is opened, film rewind will stop at mid-roll; to restart film rewind, press the  and  buttons again.

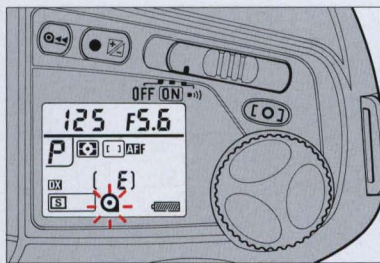



3 After rewind automatically stops, confirm frame counter shows **E**, and film installation symbol  blinks for a few seconds.

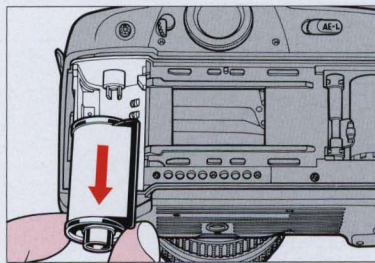

4 Open camera back and remove film cartridge.

To conserve battery power, turn off the power switch when you are not using the camera. Always remove batteries before storing a camera to prevent damage due to leaking batteries.

# GENERAL FUNCTIONS

This chapter explains the various modes of the N90 camera's operation. Please review it thoroughly.

## FILM ADVANCE MODE

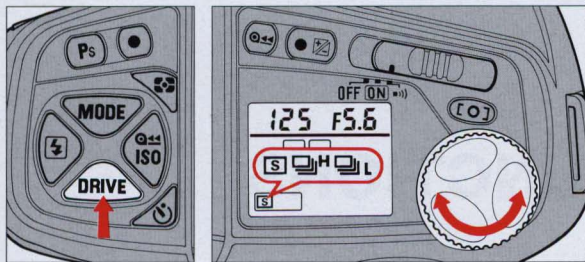

There are three automatic film advance modes. To choose a mode, press and hold the film advance mode button and rotate the command dial. Set **S** for single-frame shooting, **H** for continuous low-speed shooting or **L** for continuous high-speed shooting, and so on.

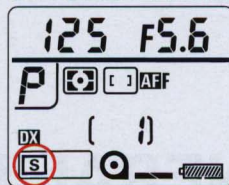

## SINGLE-FRAME SHOOTING

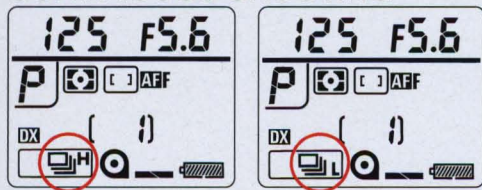

With the film advance mode at **S**, fully depressing the shutter release button takes one picture and automatically advances the film by one frame. Film is advanced immediately after the shutter closes whether you remove your finger from the shutter release button or keep the button depressed. To take the next shot, lift your finger from the button, then fully depress it again.

## CONTINUOUS SHOOTING



Shots are taken continuously as long as you keep the shutter release button fully depressed. You have a choice of shooting speeds: approx. 3.6 fps (frames per second) in the  mode, and approx. 2.0 fps in the  mode—with fresh alkaline AA-type batteries at normal temperature and at shutter speeds higher than 1/250 sec. in the Manual exposure and Manual focus modes. With shutter speeds slower than 1/250 sec., the framing rate becomes progressively slower in proportion to the shutter speed in use. If Focus Tracking is on, the maximum shooting speed is approx. 3.0 frames per second in the  mode.

# EXPOSURE METERING SYSTEM

The Nikon N90 has three type of exposure metering systems— Matrix Metering, Center-Weighted Metering and Spot Metering.

## MATRIX METERING

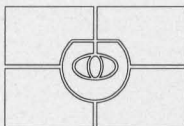

This system is ideal for quick operation in any exposure mode (pp. 49-66). With D-type AF Nikkor lenses including AF-I Nikkor, 3D Matrix Metering is automatically activated. 3D Matrix Metering uses three types of data: (1) scene brightness, (2) scene contrast and (3) focused subject's distance (Distance Information). Data on scene brightness and contrast are detected by the camera's 8-segment Advanced Matrix Sensor, while data on the focused subject's distance is detected and relayed by the D-type AF Nikkor lens in use. In addition, the information sent by the camera's autofocus system indicating whether the main subject is centered is also considered in the computation. By analyzing these data, the N90's built-in microcomputer is able to provide correct exposure even in extremely complex lighting situations.

If a non-D-type lens is used, Advanced Matrix Metering is performed. Although lens' Distance Information is not given, 8-segment Matrix sensor provides the correct exposure in most lighting situations.

Note that Matrix Metering system can be used only with lenses that have a built-in CPU (such as AF Nikkor and AI-P lenses.)



## CENTER-WEIGHTED METERING

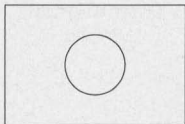

With 75% of the meter's sensitivity concentrated on the 12mm-dia. circle in the viewfinder and 25% outside this circle, this meter becomes useful in situations where you want to base exposure on a specific area in the scene. In the auto exposure mode, to measure the brightness of the picture's off-center portion, use the camera's AE-L lever (pp. 88-89).



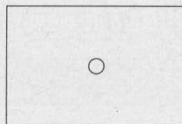

## SPOT METERING

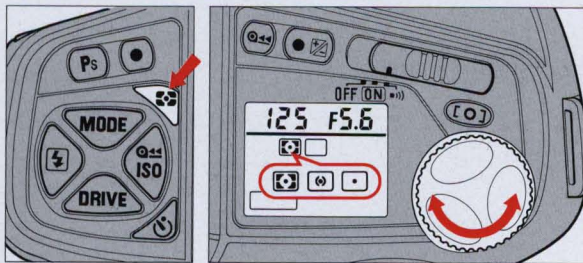

Nearly 100% of the meter's sensitivity is concentrated on the 3mm circle in the center of the viewfinder. Use this meter for really selective exposure control—achieving the best results requires experience.

## SETTING METERING SYSTEM



While pressing the metering system (  ) button, rotate command dial until the desired symbol— for Matrix Metering,  for Center-Weighted Metering or  for Spot Metering—appears in the LCD panel.

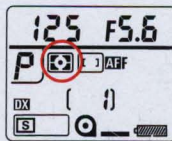

Matrix Metering

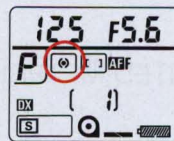

Center-Weighted  
Metering

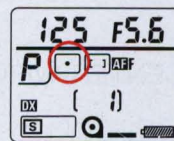

Spot Metering

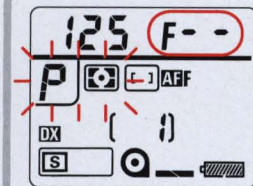

**If you are using a lens without CPU, or accessories such as bellows or extension rings**

8-segment Matrix Metering automatically switches off and Center-Weighted Metering switches on while the  symbol blinks. (If Auto Multi-Program or Shutter-Priority Auto is set on the camera, the exposure mode also switches automatically to Aperture-Priority Auto with **F--** and blinking exposure mode indicator.) In this case, use Center-Weighted Metering or Spot Metering.





# FOCUS

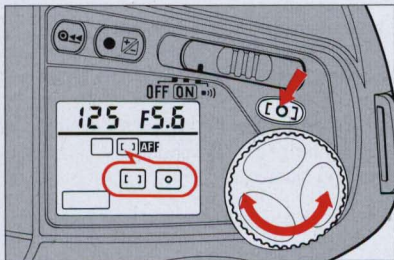

## FOCUS AREA



The N90's autofocus system offers a choice of two focus areas: Wide and Spot.

While pressing focus area button, rotate command dial until the desired symbol— for Wide Area or  for Spot Area—appears in the LCD panel.

### When using Nikon dedicated Speedlight

When a Nikon dedicated Speedlight connected to the camera is turned on, Wide Area is automatically switched over to Spot Area focus. In this case,  blinks in the LCD panel and  appears inside the viewfinder.

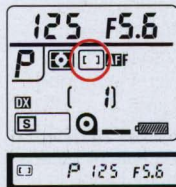

Wide-Area Autofocus

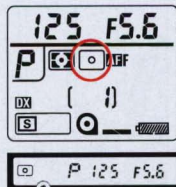

Spot-Area Autofocus

The Wide-Area focus brackets delineate the focus detecting area in the viewfinder. Subjects of sufficient brightness and detail can be detected within these brackets. In addition to general photography, autofocus using Wide-Area focus brackets is suited to action photography in which the moving subject requires a wide-range focus detection area. However, focus detection may not be possible if the subject is too small to fully cover the Wide-Area focus brackets. If various subjects, each at a different distance, fall within the focus

detection area, focus will be confirmed for a single subject as follows:

- For subjects of equal brightness: the closer one will be focused.
- For subjects of unequal brightness: the brighter one will be focused.

Spot Area AF, in which the focus detecting area is shown by the 3mm-dia. circle at the center of the viewfinder, is recommended in the following situations:



**a.** Subject considerably smaller than the Wide-Area focus brackets\*



**b.** Subject obscured by an object, such as a fence, in the foreground



**c.** A particular portion of the subject must be in focus, such as the eyes in a portrait



**d.** Strongly backlit subject, such as someone standing beside bright window\*\*

\* Use focus lock. See "AUTOFOCUS WITH MAIN SUBJECT OFF CENTER" on pages 40 to 43.

\*\* To give correct exposure on your subject, see "AE-L LEVER" on pages 88 to 89 or "TO OBTAIN METER READING FOR A PARTICULAR SUBJECT IN MANUAL EXPOSURE MODE" on pages 90 to 91.

# AUTOFOCUS

The Nikon N90 has two autofocus modes, Single Servo AF with Focus-Priority and Continuous Servo AF with Release-Priority. In either autofocus mode and in any film advance mode, Focus Tracking automatically activates when the subject starts moving. Focus Tracking enables the camera to analyze the speed of the moving subject according to the focus data detected, and to obtain correct focus by anticipating the subject's position—and driving the lens to that position—at the exact moment of exposure. You can thus obtain correctly focused pictures for many moving subjects.

## Data Link System users

You can give Focus-Priority to Continuous Servo AF and/or Release-Priority to Single Servo AF. For Single Servo AF in continuous shooting, you can also cancel focus detection and lens driving for the next shot after the first shot is taken so that the subject focus remains locked. For details, see the Nikon AC-1E card's instruction manual.

## Caution

Do *not* attempt to turn the lens focusing ring or impede its rotation when the focus mode selector is set to **S** or **C**.

In addition to AF Nikkor lenses (including D-type AF Nikkor and AF-I Nikkor lenses except the AF Nikkor lenses for F3AF), autofocus is possible with AF Teleconverter TC-16A attached to non-AF AI-Nikkor lenses with a maximum aperture of f/3.5 or brighter. AI-Nikkor lenses that cannot be used with the TC-16A are:

- AI-S type 20mm f/2.8
- AI-S type ED 400mm f/2.8 IF
- AI-S type ED 400mm f/3.5 IF
- 28mm f/2 (with factory serial No. 540020 or smaller)
- 28mm f/2.8 (No. 500000 or smaller)
- 35mm f/1.4
- 35mm f/2 (No. 931000 or smaller)
- 35mm f/2.8 (No. 880000 or smaller)
- 50mm f/1.4 (No. 398000 or smaller)
- 50mm f/2 (No. 364000 or smaller)
- ED 400mm f/3.5 IF
- Micro 55mm f/3.5
- All modified-AI-Nikkor and PC-Nikkor lenses

*For details, see the TC-16A's instruction manual.*

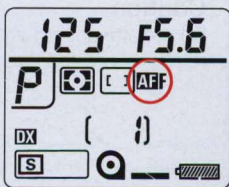
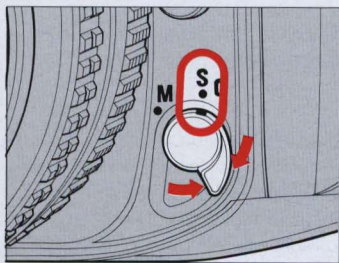

### Single Servo AF with Focus-Priority

For Single Servo AF with Focus-Priority, set the focus mode to **S**.

You lightly press the shutter release button, the lens starts adjusting for focus. Because the priority is on correct focus, the shutter cannot be released until the subject is in focus. After focus is achieved, the focus remains locked for as long as the shutter release button is lightly pressed. This feature is useful, especially when recomposing the picture with the main subject off center. However, if the camera-to-subject distance changes, you have to refocus.

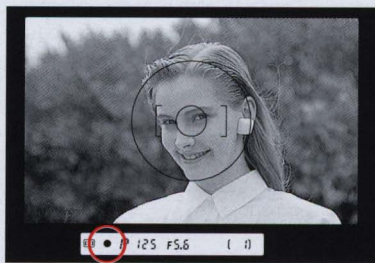

Stationary subject is in focus

**With a stationary subject:** Lightly press the shutter release button. When the subject is in focus, the lens stops moving, the in-focus indication ● appears in the viewfinder, and focus is locked. If the subject moves, remove your finger from the shutter release button, then lightly press it again to re-start autofocus.

When a stationary subject comes into focus, a double beep sounds (if set).

- ◀ Subject is located closer than the closest focusing distance of the lens. Move away from subject and refocus.
- ▶ Appears when TC-16A is used, alerting that the lens focusing ring is not set at infinity ( $\infty$ ). Set focus mode selector to M, set lens focusing ring to  $\infty$ , set focus mode selector to S again, then refocus.





Moving subject is expected to be in focus

**With a moving subject:** Lightly press the shutter release button. Focus Tracking is automatically activated with ▶ ● ◀ indication in the viewfinder. As soon as the subject is expected to be in focus, ▶●◀ appears, indicating that you can release shutter. If subject stops and ● appears without ▶ ◀, focus is locked. If subject moves again, remove your finger from the shutter release button and lightly press it again to start autofocus with Focus Tracking.

- Single Servo AF with Focus-Priority is convenient for off-center subjects. See pages 40 to 41.
- After shooting with the film advance mode selector set at **S**, you do not have to remove your finger from the shutter release button for the next shot. Slightly lift your finger from the button (but maintaining the button in the half-depressed position) then fully depress it to release the shutter again. The focus setting will have remained unchanged from the prior setting. In the Single Servo AF with Focus-Priority mode, focus remains locked even after the shutter is released, unless you remove your finger from the shutter release button. With film advance mode set at **H** or **L**, camera detects focus every time the shutter is released.
- With a moving subject, depending on subject status and lens in use, slightly out-of-focus pictures may result.



If ▶ ◀ blinks in the viewfinder: Autofocus is not possible (p. 44).

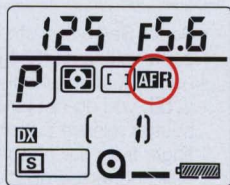
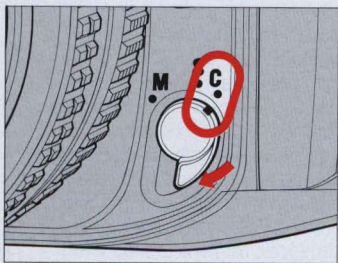

## Continuous Servo AF with Release-Priority

Under some conditions, such as very fast action situations, you may want to take a picture even if focus has not been successfully accomplished. In such cases, use this mode. Set focus mode to **C** to use Continuous Servo AF with Release-Priority.

In Continuous Servo autofocus mode, as you lightly press the shutter release button, focus detection begins and the lens focuses for as long as you keep the shutter release button lightly pressed. Since the priority is on shutter release, you can fully depress the shutter release button regardless of focus status.

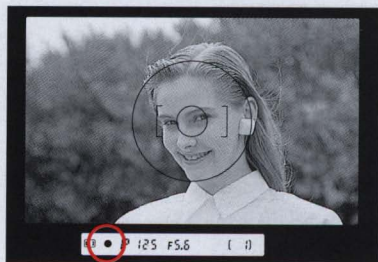





Stationary subject is in focus

**With a stationary subject:** Lightly press the shutter release button to start autofocus operation. When the subject is in focus, the camera's autofocus motor (or the built-in motor of an AF-I Nikkor lens) stops driving the autofocus lens and ● lights up. Unless you remove your finger from the shutter release button, the motor will start driving the lens again to obtain an in-focus picture if the focus distance changes.

- ◀ Subject is located closer than the closest focusing distance of the lens. Move away from subject and refocus.
- ▶ Appears when TC-16A is used, alerting that the lens focusing ring is not set at infinity (∞). Set focus mode



Moving subject is expected to be in focus

**With a moving subject:** Lightly press the shutter release button and Focus Tracking is automatically activated with  indication. As soon as the subject is expected to be in focus, viewfinder shows . Focus Tracking remains on as long as you keep lightly pressing the shutter release button. When the subject stops, the viewfinder shows  without .

- As focus is not locked in Continuous Servo AF, to take an off-center subject, use AF-L button. See pages 42 to 43.
- With a moving subject, depending on subject status and lens in use, slightly out-of-focus pictures may result.

selector to M, set lens focusing ring to  $\infty$ , set focus mode selector to C again, then refocus.



If  blinks in the viewfinder: Autofocus is not possible (p. 44).



## AUTOFOCUS WITH MAIN SUBJECT OFF CENTER

### In Single Servo AF mode

As previously noted, in Single Servo autofocus, focus is locked as long as the shutter release button is kept lightly pressed. Use this feature for off-center subjects. In the following procedure, Spot-Area AF demonstration photos are used.

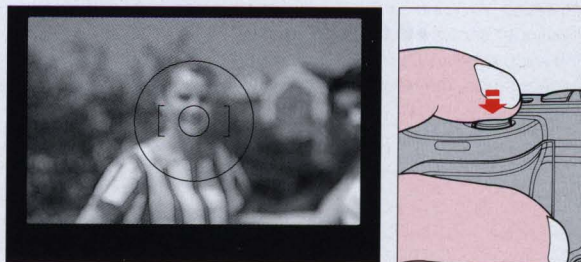

- If there is substantial difference of brightness between subject and background, switch to Center-Weighted or Spot Metering and use AE-L lever. See pages 88 to 89.
- With a moving subject, focus cannot be locked.

1. Position focus brackets on subject and lightly press shutter release button to start autofocus operation.



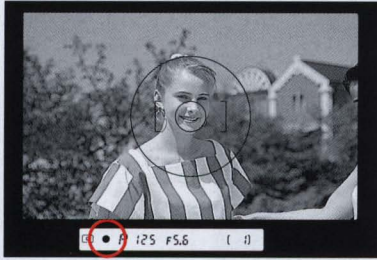

2. Confirm in-focus indicator ● appears (and In-Focus Signal beeps if set) in viewfinder.



3. Keeping the shutter release button lightly pressed, recompose, then fully depress shutter release button to take picture.

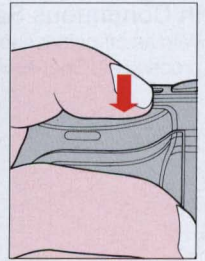

## In Continuous Servo AF mode

With an off-center subject, use AF-L button. In the following procedures, Spot-Area AF demonstration photos are used.

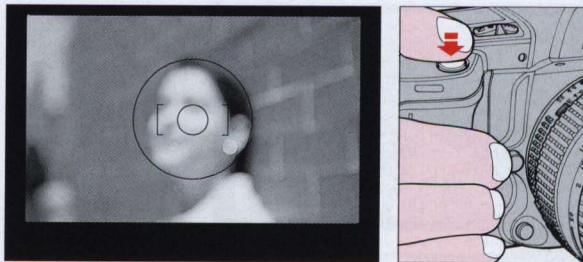

1. Position focus brackets on subject and lightly press shutter release button to start autofocus operation.

### **MF-26 or Data Link System users**

The MF-26 enables you to set simultaneous lock of autofocus and auto exposure. For details, see MF-26's instruction manual.

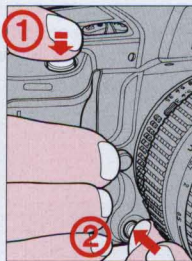

2. Keeping shutter release button lightly pressed, confirm in-focus indicator ● appears in viewfinder. Then press and hold AF-L button to lock focus. Keep holding AF-L button until next step is completed.

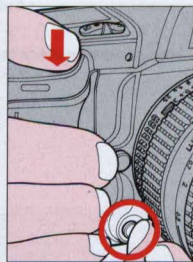

3. While holding AF-L button in, recompose, then fully depress shutter release button to take picture.



## SPECIAL FOCUSING SITUATIONS

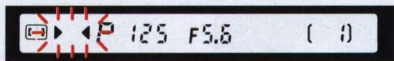

Autofocus operation depends on general lighting, subject contrast and detail, and other technical factors. In rare situations where autofocus (and manual focus with Electronic Rangefinder) is not possible, ► ◀ blinks telling you to focus manually with clear matte field (p. 48) or perform autofocus on another subject located at same distance.

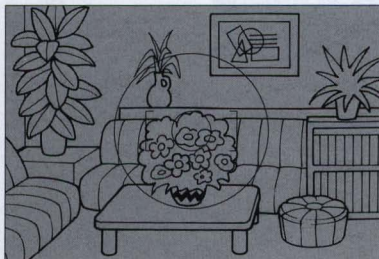

### A. Very dark subject

Focus manually with clear matte field, or for autofocus, focus on another brighter subject located at same distance, then use focus lock (pp. 38-43). Or, use a Nikon autofocus Speedlight to perform autofocus with Speedlight's AF illuminator.



### B. Low contrast subject

Focus manually with clear matte field, or for autofocus, focus on another subject at same distance but with more contrast, then use focus lock (pp. 38-43).

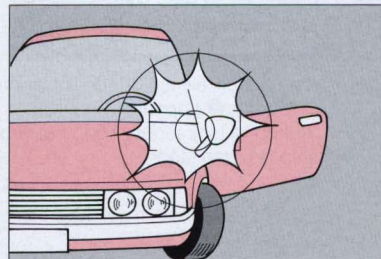

**C. Strongly backlit subject or bright subject with shiny surface such as silver or aluminum, or scene in which there is a pronounced difference in brightness, such as the light patterns created by blinds.**

Focus manually with clear matte field.



In the following situations, ignore in-focus indicator ● or ▶●◀.

- **Scene with subject located at different distances. (For example, when shooting a person over a fence or when shooting animals inside a cage)**

Use Spot Area for autofocus (page 34) or focus manually with clear matte field.

- **With an extremely bright object near your subject**

Use Spot Area for autofocus (page 34) or focus manually with clear matte field.

- **When using a linear polarizing filter\*, or other special filter such as a soft-focus filter.**

Focus manually with clear matte field.

\* *Circular polarizing filter can be used in connection with autofocus operation.*

## MANUAL FOCUS

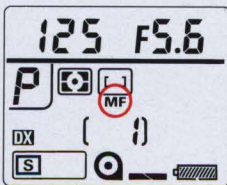
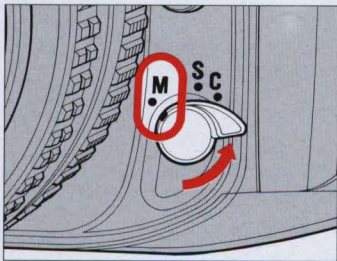

To focus manually, set the focus mode selector to **M**. (If the lens has an A-M switch, set it to M. If you are using an AF-I Nikkor lens, set the focus mode ring to M or M/A.)

There are two ways of assuring precise manual focus: with the Electronic Rangefinder or with the viewfinder's clear matte field.

## Manual focus with Electronic Rangefinder

The Electronic Rangefinder enables you to see focus status with the viewfinder indications while you are manually focusing. It works with most Nikon lenses (including AF Nikkor when operated manually) which have a maximum aperture of f/5.6 or faster. (For a complete list of usable lenses, see LENS COMPATIBILITY CHART on p. 104).

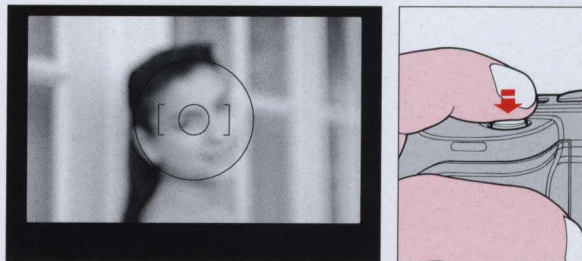

1. Look through viewfinder and position focus brackets on main subject. Then lightly press shutter release button.

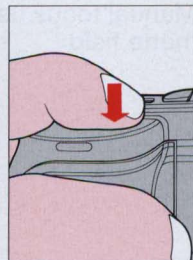
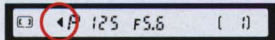
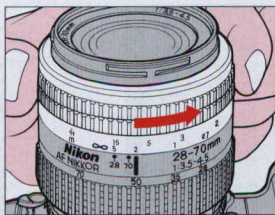
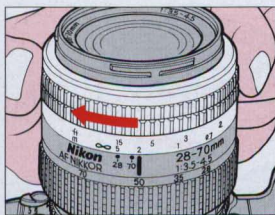

2. Keeping shutter release button lightly pressed, rotate lens focusing ring in direction indicated by focus-to-left arrow (◀) or focus-to-right arrow (▶), until arrow disappears and in-focus indicator ● appears.

If focus-to-left arrow (◀) does not disappear when you turn focus ring counterclockwise to the limit, subject is closer than the distance at which the lens is able to focus. Move back from subject.

3. Confirm in-focus indicator ● appears, then fully depress shutter release button to take picture.

For special focusing situations shown on page 44, ▶ ◀ blinks to indicate that the Electronic Rangefinder does not correctly work. Focus with clear matte field (p. 48).

## Manual focus using clear matte field

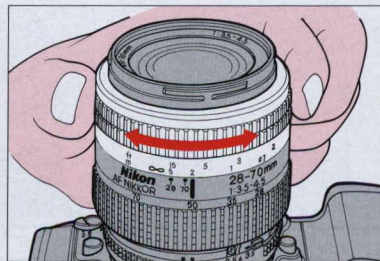
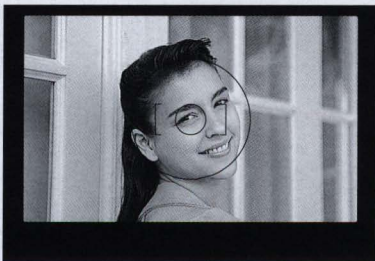

Look through viewfinder and rotate lens focusing ring until image on clear matte field appears sharp.



# EXPOSURE MODE

Light reaching the film is controlled by shutter speed and lens aperture. The proper combination results in a correct exposure. Shutter speed and lens aperture settings are based on the ISO speed set for the film in use and the operation of the camera's exposure control system.

The relationship between aperture and shutter speed is as follows: One change in shutter speed either doubles or halves

the amount of light transmitted. For example, a shutter speed of 1/500 sec. passes half the light of 1/250 and double the light of 1/1000 sec. The aperture f/8 passes half the light of f/5.6 and double the light of f/11. If the correct exposure for a scene is 1/500 at f/8, then we can also select 1/250 at f/11 or 1/1000 at f/5.6 and achieve the same exposure results, and so on.

## Metering range (for Matrix and Center-Weighted Metering with AF Nikkor 50mm f/1.4 lens)

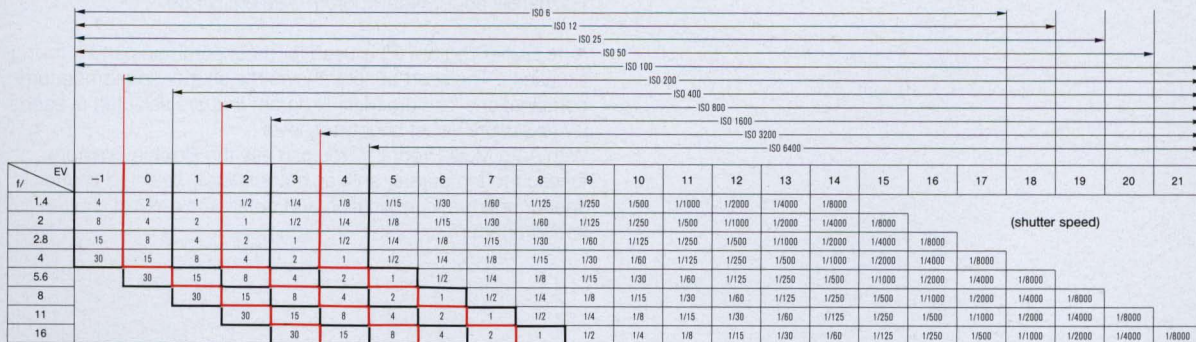

Metering range depends on the lens in use. With a lens having aperture from f/2.8 to f/32, metering range at ISO 100 will be from EV1 to EV23.

## SELECTING EXPOSURE MODE

Selecting the exposure control mode means deciding if you want the shutter speed and/or lens aperture to be set automatically or manually.

The Nikon N90 camera offers two types of programmed auto exposure modes, Auto Multi-Program (**P**) and Vari-Program (**P<sub>s</sub>**), as well as Shutter-Priority Auto (**S**), Aperture-Priority Auto (**A**), and Manual (**M**) exposure modes.

### Programmed auto exposure modes (**P/P<sub>s</sub>**)

With the N90's microcomputer choosing the combination of shutter speed and aperture automatically, you can concentrate on picture composition, without worrying about exposure.

*Note that programmed auto exposure modes operate only with Nikon lenses that have a built-in CPU (AF Nikkor and AI-P Nikkor lenses).*

When **P<sub>s</sub>** for Vari-Program is selected, you have a choice of seven options: (1) Portrait Program, (2) Portrait Program with Red-Eye Reduction, (3) Hyperfocal Program, (4) Landscape Program, (5) Silhouette Program, (6) Sport Program and (7) Close-Up Program.

For details about Vari-Program, see pp. 67-85.

Auto Multi-Program (**P**) is used for most common picture-taking situations. The chart at right shows the shutter speed/aperture combinations for Auto Multi-Program that are selected at each EV (exposure value) brightness level.

With Auto Multi-Program, you can use the Flexible Program function to temporarily shift an automatically selected shutter speed/aperture combination and obtain the desired shutter speed/aperture (p. 55).

## Program chart of Auto Multi-Program

To check shutter speed and aperture values, follow either the black or red line to where it intersects the diagonal line.

Auto Multi-Program chart (ISO 100)

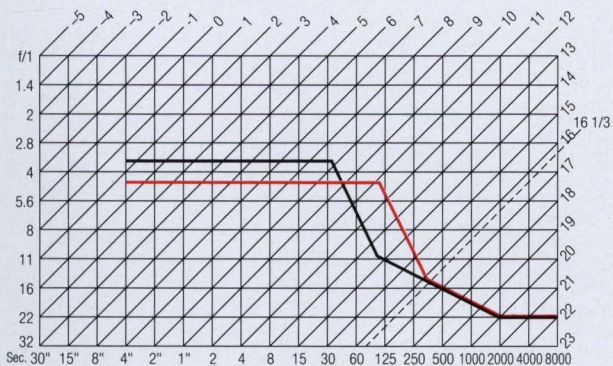

- With AF Zoom 28-70mm f/3.5-f/4.5 at 28mm setting
- With AF Zoom 28-70mm f/3.5-f/4.5 at 70mm setting

## Shutter-Priority Auto exposure mode

You manually set the shutter speed you want. To freeze the action, use a high shutter speed; to create motion effects, choose a slower shutter speed. The N90's microcomputer automatically sets the proper aperture to match the manually selected shutter speed for correct exposure. See pp. 56-59 for Shutter-Priority Auto operation.

*Note that Shutter-Priority Auto exposure mode operates only with Nikon lenses that have a built-in CPU (AF Nikkor and AI-P Nikkor lenses).*

## Aperture-Priority Auto exposure mode

You can control depth of field by varying the aperture. Smaller apertures make the background and foreground sharper (recommended for landscape pictures) while larger apertures tend to blur the background (recommended for portraits). Your selected aperture will determine the shutter speed that is automatically set by the camera's microcomputer. When using smaller apertures with correspondingly slower shutter speeds, remember that, generally, any speed below 1/(focal length in use) second, requires the use of a tripod to prevent picture blur due to camera shake. The higher the corresponding shutter speed to the aperture you set, the easier it is to stop action. Adjust the selected aperture if the speed is not appropriate for conditions or the specific effect you want. For Aperture-Priority Auto operation, see pp. 60-62.

## Manual exposure mode

Manual exposure control allows you to make both aperture and shutter speed settings. For a technically correct exposure, follow the recommendation of the camera's light meter, as indicated by LCD readout. To achieve a specific creative effect (e.g., intentional blur, intentional under- or over-exposure), disregard the LCD and modify the recommended exposure settings.

For Manual exposure operation, see pp. 63-66.



**Pictures taken at different shutter speeds**



High shutter speed



Slow shutter speed

**Pictures taken at different apertures**

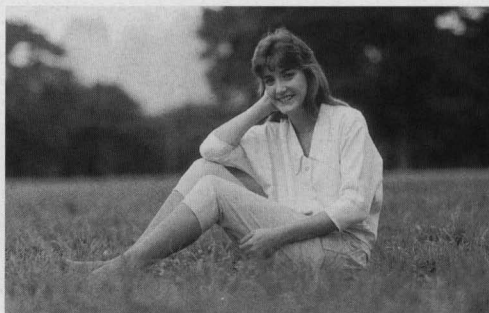

Wide aperture



Narrow aperture

## SETTING EXPOSURE MODE

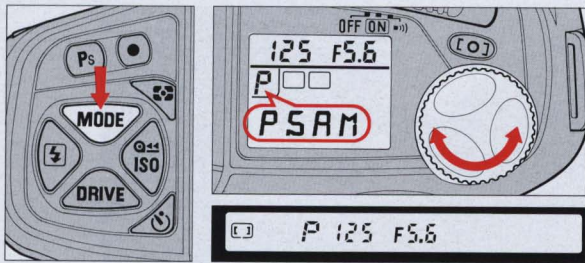

While pressing **MODE** button, rotate command dial. The exposure mode changes as in the following sequence:

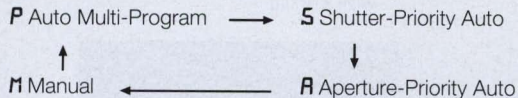

To activate Vari-Program, use **Ps** button. For details, see pp. 67-85.

### Data Link System users

If you have already created an original program line as your own Custom Program and downloaded it from the Electronic Organizer to the camera, **P** with **LP** will appear in the LCD between **M** and **P**. For details, see the AC-1E card instruction manual.

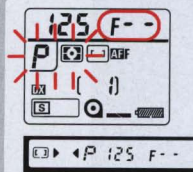

**For users of lenses that have no CPU, or accessories such as bellows attachment or extension rings**

Use Aperture-Priority Auto or Manual exposure mode. Auto Multi-Program or Shutter-Priority Auto exposure mode automatically shifts to Aperture-Priority Auto exposure mode with **F--** and blinking exposure mode indicator. (If Matrix Metering is set on the camera, metering system is also automatically shifted to Center-Weighted and  blinks). Vari-Program cannot be used for these lenses or accessories.

## FLEXIBLE PROGRAM

If you want to change the shutter speed/aperture combination of Auto Multi-Program, use the Flexible Program function.

Flexible Program enables you to temporarily change an automatically set shutter speed/aperture combination in 1 EV steps, while maintaining the correct exposure.

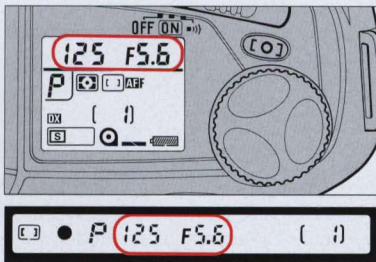
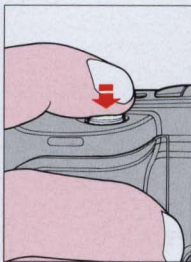

1. Lightly press shutter release button.

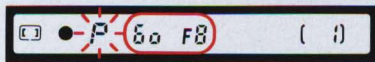
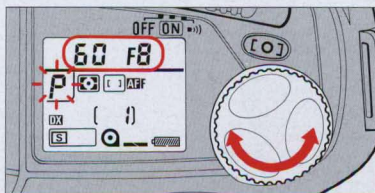

2. Turn command dial until desired shutter speed or aperture value appears in viewfinder and in LCD panel. The exposure mode indicator (P) blinks to indicate the program has been shifted or changed.

- The shifted program is maintained as long as the exposure meter stays on, unless you turn the command dial to the previous shutter speed/aperture. As soon as the meter switches off (i.e., the viewfinder and LCD panel displays disappear), Flexible Program is cancelled. Flexible Program is also cancelled when you switch the exposure mode to another mode, readjust the camera settings or turn off the power switch.
- Flexible Program cannot be used with Vari-Program. When **P<sub>s</sub>** is selected, the procedure just explained does not shift the shutter speed/aperture combination.



## OPERATION IN SHUTTER-PRIORITY AUTO EXPOSURE MODE

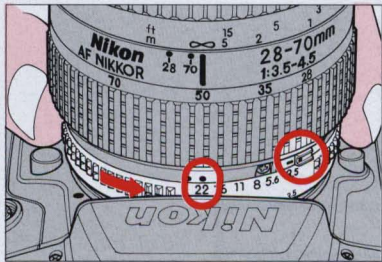

1. Set lens to its minimum aperture setting (highest f-number). With AF Nikkor and AI-P Nikkor lenses, lock lens aperture at minimum setting (refer to lens instruction manual).

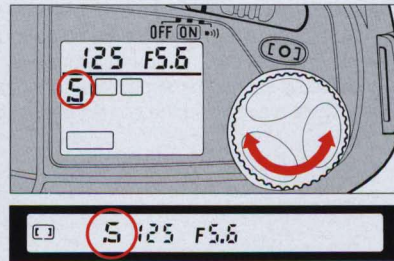
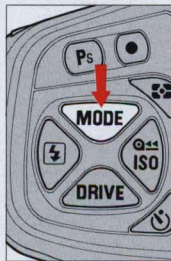

2. While pressing **MODE** button, rotate command dial until "S" appears on LCD panel and viewfinder.

If "bulb" is set on the camera, selecting the Shutter-Priority (S) Auto exposure mode will cause **bulb** to blink—a warning that the "bulb" setting cannot be used in the S mode.



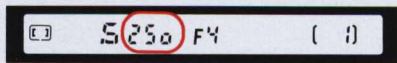
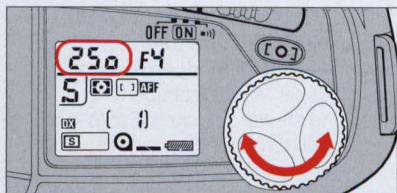

3. Remove finger from **MODE** button, and rotate command dial to select desired shutter speed.

Shutter speed indication changes one step at a time in the following sequence:

30'' 15'' 8'' 4'' 2'' 1'' 2 4 8 15 30 60 125 250 500  
1000 2000 4000 8000

If meter has automatically turned off, along with LCD indications, turn on meter—and LCD readout—again by lightly pressing shutter release button.

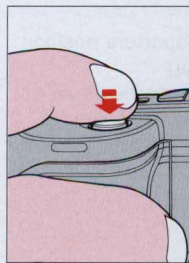

4. Look inside viewfinder, compose and lightly press shutter release button. Confirm the automatically set aperture value.

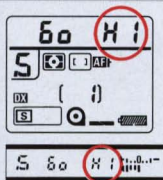

If **H 1** appears in the aperture position with electronic analog display\*—**Overexposure alert\*\***: Select higher shutter speed or use Nikon ND filter.

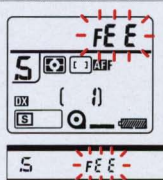

If **F E E** blinks in the aperture position—**Lens setting error alert\*\***: Lens is not set to smallest aperture setting and shutter is locked. Set lens to smallest aperture, and lock setting.

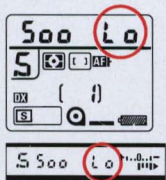

If **L 0** appears in the aperture position with electronic analog display\*—**Underexposure alert\*\***: Select slower shutter speed, or use accessory Nikon Speedlight.



If **⚡** mark in green appears—**Flash photography is recommended**: If subject brightness is insufficient, **⚡** mark lights up in green. Use Nikon Speedlight.

\* Shows value difference from correct exposure. If difference is beyond  $\pm 1$  EV, **▶** for underexposure or **◀** for overexposure appears.

\*\* For overexposure alert, underexposure alert and lens setting error alert, electronic beeper sounds, if set.

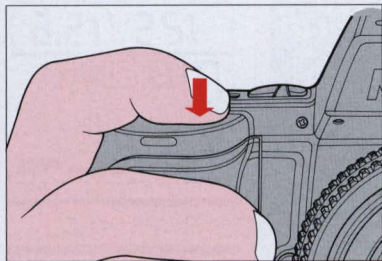

5. To take the picture, fully depress shutter release button.

## OPERATION IN APERTURE-PRIORITY AUTO EXPOSURE MODE

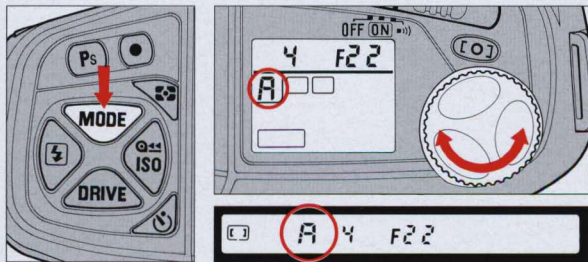

1. While pressing **MODE** button, rotate command dial until **A** appears on LCD panel and viewfinder.
  - If using an AF Nikkor or AI-P lens, make sure it is not locked to smallest aperture before next step.

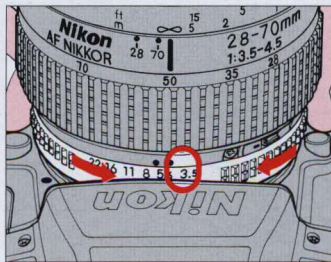

2. Remove finger from **MODE** button and set lens to desired f-number by rotating lens aperture ring. Aperture set on lens is indicated in the LCD panel and viewfinder as follows:  
**F 1 F 1.4 F 2 F 2.8 F 4 F 5.6 F 8 F 11 F 16 F 22 F 32 F 45 F 64**  
(Available apertures limited to those of lens in use.)
  - Intermediate figure (e.g. **F 1.8**, **F 3.3**) displayed indicates maximum aperture of lens in use. Also, with zoom lenses, the maximum aperture for different focal length settings appears in 1/6 EV steps.

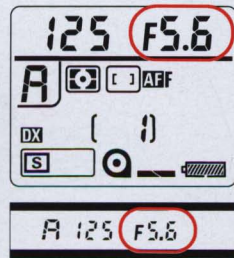



If meter has automatically turned off and the LCD panel is off, turn meter on again by lightly pressing shutter release button.

**With lenses having no CPU, F - appears instead of aperture value in LCD panel and viewfinder.**

**With AI-type lenses including AI-modified Nikkor lenses:** Confirm aperture value on lens barrel.

**With lenses having fixed aperture, such as Reflex-Nikkor lenses:** Aperture cannot be changed.

**With lenses having no auto diaphragm such as PC-Nikkor lenses:** Switch to Manual exposure mode (pp. 63-66).

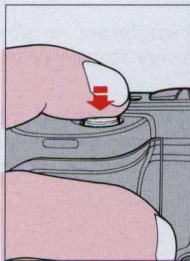

3. Look inside viewfinder, compose and lightly press shutter release button. Confirm automatically set shutter speed.

If the selected shutter speed is 1/(focal length) sec. or slower, picture blur may occur\*. To avoid this, hold camera very steadily or use a tripod.

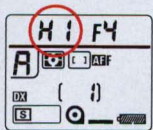

If **H !** appears in the shutter speed position with electronic analog display\*\*—Overexposure alert\*: Select smaller aperture (larger f-number) or use ND filter.

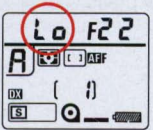
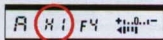

If **L !** appears in the shutter speed position with electronic analog display\*\*—Underexposure alert\*: Select wider aperture (smaller f-number), or use a Nikon Speedlight.

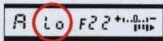

\* Electronic beeper sounds if set. If you are using Data Link System, you can cancel picture-blur alert.

\*\* Shows value difference from correct exposure. If difference is beyond  $\pm 1$  EV, **▶** for underexposure or **◀** for overexposure appears.

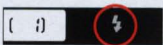

If **⚡** mark in green appears—Flash photography recommended: If subject brightness is insufficient, ready-light blinks. Use Nikon Speedlight.

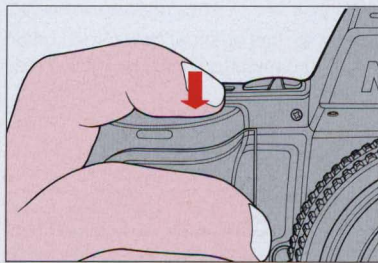

4. To take the picture, fully depress shutter release button.

## OPERATION IN MANUAL EXPOSURE MODE

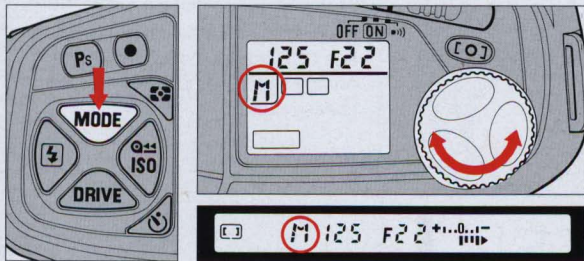

1. While pressing **MODE** button, rotate command dial until **M** appears in the LCD panel and viewfinder.
  - If using an AF Nikkor or AI-P lens, make sure it is not locked to smallest aperture before proceeding to next step.

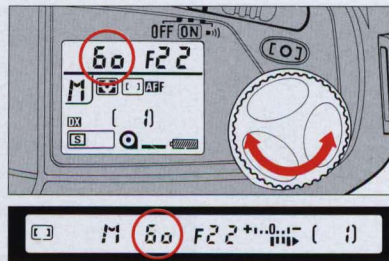

2. Remove finger from **MODE** button, set shutter speed by rotating command dial.
  - In Manual exposure mode, you can set shutter speed to **bulb** for long time exposure by rotating command dial. For details about **bulb** setting, see pp. 98-99.



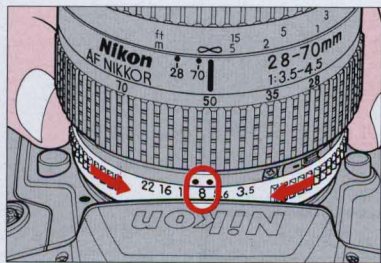

Set aperture by rotating the lens aperture ring.

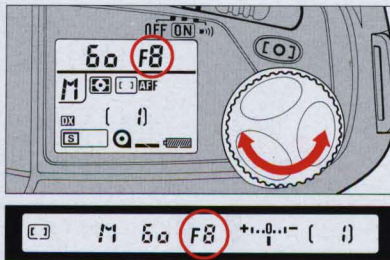

If meter has automatically turned off and LCD readout is off, turn meter on again by lightly pressing shutter release button.



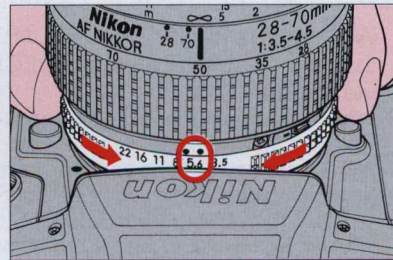
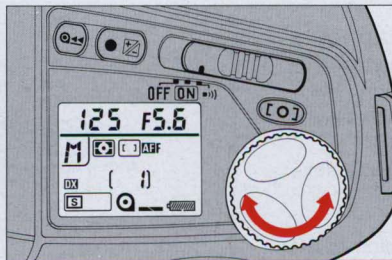

3. Look into the viewfinder, compose and lightly press shutter release button.  
Adjust aperture and/or shutter speed until electronic analog display shows "0" or desired amount.

Electronic analog display blinks when the shutter speed/aperture set on the camera is beyond the metering range of the N90.

Examples

<p>Over +1EV</p>	<p>+1EV</p>	<p>+1/3EV</p>
<p>±0EV</p>	<p>-2/3EV</p>	<p>Below -1EV</p>

With lenses having no CPU, **F -** appears instead of aperture value in LCD panel and viewfinder.

With AI-type lenses including AI-modified Nikkor lenses: Confirm aperture value on lens barrel.

With lenses having fixed aperture, such as Reflex-Nikkor lenses: Aperture cannot be changed. Adjust exposure by changing shutter speed.

With lenses having no auto diaphragm such as PC-Nikkor lenses: Lens is stopped down when a smaller aperture (larger f-number) is selected. Focus manually with the lens set at maximum aperture.

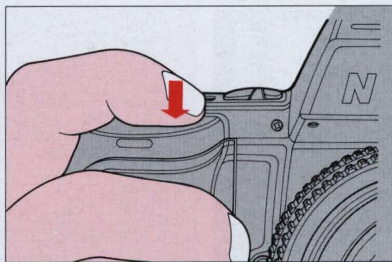

4. To take the picture, fully depress shutter release button.

# VARI-PROGRAM

Here's how you can benefit from the N90's Vari-Program options for specific picture-taking situations.

## WHAT IS VARI-PROGRAM?

---

Programmed exposure control enables the camera's computer to automatically adjust both lens aperture and shutter speed for the correct exposure. The N90 camera's Matrix Metering System determines the correct exposure, applying exposure compensation as deemed necessary by the computer's program. However, other factors can affect the picture, including the use of different shutter speeds and different apertures.

The N90's Auto Multi-Program is designed to coordinate the selection of shutter speed and aperture for average situations. It guides the exposure control system into using reasonably high shutter speeds to avoid blur due to camera shake. The N90 incorporates a versatile Vari-Program System that gives you the option to choose from different programs, each designed to accommodate different picture-taking situations. Please review the concept behind and recommended use for each program, using each as described, or in a different way to express your own picture-taking creativity. Once you understand how each program operates, you'll be able to experiment, using each program for an application different from its originally intended use.

Please note that the effect achieved by using each Vari-Program can be reproduced with the use of other exposure control methods such as Shutter-Priority Auto, Aperture-Priority Auto and Manual. But with Vari-Program control, you allow the camera's computer to take care of all exposure control tasks while you concentrate on composition. This versatility is one of the highlights of the N90 camera's advanced exposure control system.



### **Portrait Program (P a)**

This enables you to take a portrait, with your subject standing out against a blurred background.

### **Portrait Program with Red-Eye Reduction (r E)**

Notice how, when taking pictures of people in dim light with flash, sometimes their eyes appear red. This program reduces the possibility of “red-eye” in color pictures or “white-eye” in B&W.

### **Hyperfocal Program (H F)**

The program to use if you want both your main subject and the background to appear sharper.

### **Landscape Program (L R)**

Ideal for most scenes, with both far and near objects appearing more sharply focused.

### **Silhouette Program (S L)**

Your subject will literally look like a silhouette against the sky or a dramatic sunset.

### **Sport Program (S P)**

Select this program to capture action. Great for sports photography or for shooting a fast-moving subject.

### **Close-Up Program (C U)**

Perfect for general close-ups, with the subject appearing sharply focused against a blurred background.

# SELECTING VARI-PROGRAM

Use Nikkor lenses with CPU such as AF Nikkor or AI-P-Nikkor lenses and be sure to set lens aperture to the minimum setting.

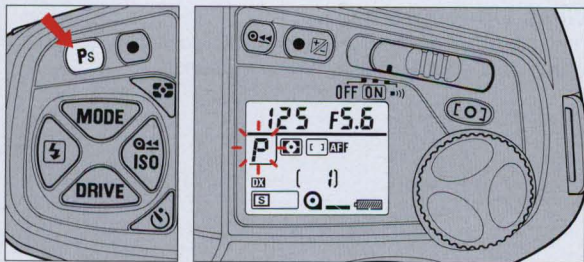

## 1. Set Vari-Program.

Press and hold **Ps** button and confirm exposure mode indication (**P**, **S**, **A** or **M**) starts blinking.

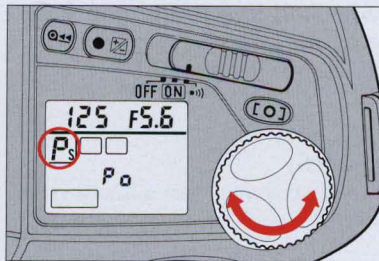

2. While keeping the **Ps** button pressed, rotate command dial until it clicks once. **Ps** appears in place of the blinking exposure mode indication and one of the Vari-Program indicators (**P<sub>a</sub>**, **r**, **E**, **H F**, **L R**, **S L**, **S P** or **L U**) appears in place of the frame counter.  
Without removing your finger from **Ps** button, to select program, continue to rotate command dial until the indication for your desired program appears on the LCD.

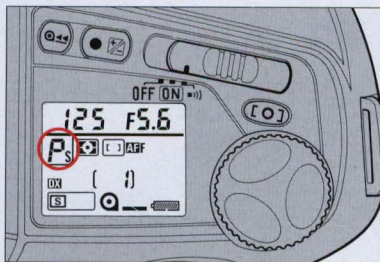

3. Remove your finger from **Ps** button. The frame counter appears again in the LCD panel but Vari-Program indicator remains in the viewfinder. When Vari-Program is set, camera settings are automatically reset as follows:

Flexible Program	Cancelled
Metering system	Matrix Metering*
Exposure compensation	±0*
Focus area	Wide*
<b>With Nikon Speedlight</b>	
Sync mode	Normal for <b>P<sub>α</sub></b> , <b>HF</b> , <b>L R</b> , <b>S L</b> , <b>S P</b> or <b>U</b> or Red-Eye Reduction for <b>r E</b>
Flash output level compensation	±0*
Flash mode (on Speedlight)	TTL auto (for Automatic Balanced Fill-Flash with TTL Multi Sensor)

\* You can change setting as desired.

## To confirm selected Vari-Program in the LCD panel

Press the **Ps** button. The selected Vari-Program (**P<sub>α</sub>**, **r E**, **HF**, **L R**, **S L**, **S P** or **U**) is temporarily indicated in place of the frame counter in the LCD panel. If you want to change the Vari-Program option, without removing your finger from the **Ps** button, rotate the command dial.

## To cancel Vari-Program

Press **MODE** button and hold it in. Confirm **Ps** starts blinking, then rotate command dial until desired exposure mode appears.

### MF-26 users

You can also confirm the selected program in the MF-26's LCD panel.

# SHOOTING WITH VARI-PROGRAM

## PORTRAIT PROGRAM

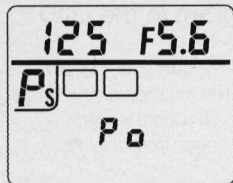

This program selects the widest aperture possible, thus minimizing depth of field and producing a sharply focused main subject against a blurred background and foreground. It makes the focused subject seem sharper and minimizes distracting elements that may appear in the foreground or background.











## Recommended lenses

AF Nikkor lenses. To obtain pronounced blurred background effect, use 85mm to 200mm telephoto lenses with a maximum aperture of f/2.8 or wider.

## Recommended camera settings

Metering system	 for Matrix*
Focus area	 for Wide* or  for Spot
Focus mode	<b>S</b> for Single Servo AF
Film advance mode	 for single-frame shooting, or  or  for continuous shooting

\* Automatically selected.

## With Nikon Speedlight

Use ISO 100 to 400 film. Other films may result in overexposed background.

## Procedure

You can follow steps 4-6 of basic shooting procedure on pp. 21-24. To make a really good portrait, make sure your subject's eyes are in sharp focus. To achieve this effect—

1. Set focus area to  for Spot.
2. Set focus mode to **S** for Single Servo AF with Focus Priority.
3. Set film advance mode to  for single-frame shooting.\*
4. Center the subject's eye inside the viewfinder.
5. Lightly press the shutter release button and confirm in-focus indicator  appears. Focus is locked as long as you keep pressing the shutter release button.
6. Without removing your finger from the shutter release button, recompose the picture as desired.
7. Fully depress the shutter release button to take the picture.

\* Continuous shooting is convenient for capturing the subject's expression which may vary from moment to moment. However, continuous shooting is not recommended for a situation where focus lock is needed. In the Single Servo AF mode, the camera detects focus every time the shutter is released during continuous shooting so focus is not locked after the first shot is taken.

## For beautiful portrait pictures

- The farther behind the subject the background is, the more blurred it will appear.
- Back lighting or side lighting usually enhances a portrait; try using fill-flash with a compensation of from -1 to -3 for pleasing results.

## PORTRAIT PROGRAM WITH RED-EYE REDUCTION (with SB-25 exclusively)

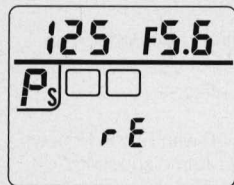

Using the same exposure control as the Portrait Program, this program adds the benefit of Red-Eye Reduction in portraits taken with flash. Use this program for both indoor and outdoor portraits, along with the SB-25 flash which offers Automatic Balanced Fill-Flash for really enhanced results.



## Recommended lenses

AF Nikkor lenses. To blur the background, use a telephoto lens with a maximum aperture of f/2.8 or brighter. However, in close-range shooting, use wider angle lenses to reduce red-eye.





## Speedlight

Nikon SB-25 Speedlight Unit.



Use ISO 100 to 400 film. Other films may cause overexposed background.

If you set the Portrait Program with Red-Eye Reduction with other Speedlight and turn on the Speedlight,  mark blinks.

## Recommended camera settings

Metering system	 for Matrix*
Focus area	 for Spot**
Focus mode	<b>S</b> for Single Servo AF
Film advance mode	 for single-frame shooting
Flash sync	 for Red-Eye Reduction***

\*Automatically selected.

\*\*Vari-Program automatically sets the camera to Wide-area focus. However, when the Nikon SB-25 AF Speedlight is connected to the camera and turned on, the focus area automatically switches to Spot. In this case,  blinks in the LCD panel, with  appearing in the viewfinder display.

\*\*\*Automatically selected and cannot be cancelled.

## Procedure

For flash shooting procedure, see SB-25's instruction manual. However, with Red-Eye Reduction function, note that it is only at the fourth flash that the shutter is released. So hold the camera steadily and make sure your subject keeps still during *all* four flashes.

## To further reduce red-eye

- Have the subject look away from the lens, toward a bright light.
- When shooting indoors, make the room as bright as possible.

*Note that red-eye tends to be more pronounced with children and cannot be as effectively reduced.*

## HYPERFOCAL PROGRAM

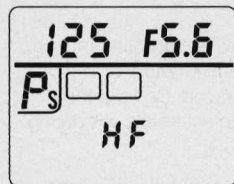

Although this program does not actually set the hyperfocal distance, it emulates the effects achieved by using very small lens apertures and short focal length lenses. The result will be a very large depth of field which yields a wide range of acceptable sharpness surrounding the focused plane of maximum sharpness. Use this program when photographing landscapes and other subjects that encompass great depth. The effect becomes more pronounced if there is an interesting foreground within the scene.











## Recommended lenses

50mm or wider angle AF Nikkor lenses, or AF Zoom-Nikkor lenses with 50mm or shorter zooming position.

## Recommended camera settings

Metering system	 for Matrix*
Focus area	 for Wide* or  for Spot
Focus mode	<b>S</b> for Single Servo AF or <b>C</b> for Continuous Servo AF
Film advance mode	 for single-frame shooting, or  or  for continuous shooting

\* Automatically selected.

## With Nikon Speedlight

Use ISO 100 to 400 film. Other films may result in overexposed background.

## Procedure

You can follow steps 4-6 of basic shooting procedure on pp. 21-24. If you don't want to center your main subject, also see pp. 40-43.

Hyperfocal program tends to select a *slow shutter speed* and smaller aperture to assure both subject and background in focus. To avoid camera shake, use a tripod.

## To ensure sharper focused subject and background

- Background must not be too far from subject.

## LANDSCAPE PROGRAM

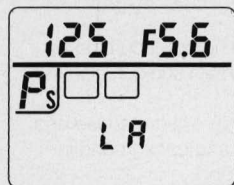







Similar in concept to the Hyperfocal Program with respect to depth of field and overall sharpness.



## Recommended lenses

Select lens according to the desired effect. If you want an expansive view, use a wideangle AF Nikkor lens. If you prefer to emphasize your subject by magnifying it, use a telephoto AF Nikkor lens.

## Recommended camera settings

Metering system	 for Matrix*
Focus area	 for Wide*
Focus mode	<b>S</b> for Single Servo AF
Film advance mode	 for single-frame shooting, or  or  or  for continuous shooting

\* Automatically selected.

## Procedure

You can follow steps 4-6 of basic shooting procedure on pp. 21-24.

Landscape Program tends to select a *slow shutter speed* and a smaller aperture to assure sharply focused landscape pictures. To avoid camera shake, use a tripod.

## Some ways to increase apparent sharpness

- Use a higher ISO film to get smaller f/stops.
- Choose a scene where the foreground and background are relatively close to each other.
- Shoot from the same position, but use a lens with a wider angle.

### MF-26 users

Use the All Mode Exposure Bracketing feature to take several pictures at different f/stops. This will give you a variety of pictures from which you can choose the best result.

## SILHOUETTE PROGRAM

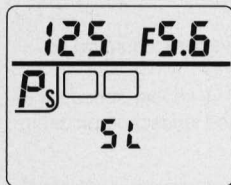

A silhouette photograph intentionally underexposes the backlit foreground subject so that it appears nearly black against the brighter background. This program works effectively only when the subject is at least 2 EV values lower (i.e., darker) than the background. It cannot be effective if the subject is frontlit or has about the same brightness as the background.











## Recommended lenses

Choose your lens according to the desired effect. If you want to picture a dynamic sunset, for example, use a telephoto AF Nikkor to magnify the sun.

## Recommended camera settings

Metering system	 for Matrix*
Focus area	 for Wide* or  for Spot
Focus mode	<b>S</b> for Single Servo AF
Film advance mode	 for single-frame shooting, or  or  for continuous shooting

\* Automatically selected.

## Procedure

You can follow steps 4-6 of basic shooting procedure on pp. 21-24.

Silhouette Program tends to select a *slow shutter speed* to produce effectively silhouetted pictures. To avoid camera shake, use a tripod.

With Nikon Speedlight on, **SL** inside the viewfinder blinks, telling you to turn off the Speedlight.

## To make your main subject beautifully silhouetted

- There must be a difference (at least 2 EV) in brightness between subject and background.

### CAUTION!

The Silhouette Program is effective for taking pictures of people silhouetted against the sun or a bright sky. However, **never look at the sun, with your naked eye, a filter or through a camera.** The sun may damage the retina and cause permanent blindness. To protect your eyes, use a medically approved solar viewing filter.

## SPORT PROGRAM

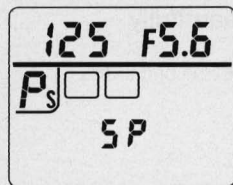





This program is designed to use select shutter speed and aperture combinations that correspond to those of the long lenses typically used for sports photography. It is biased towards higher shutter speeds to freeze action but make the subject's arms or legs, for example, appear blurred.



## Recommended lenses



AF Nikkor lenses. For a more pronounced blurred background effect, use 80mm to 300mm telephoto lenses with a maximum aperture of f/2.8 or brighter.

## Recommended camera settings

Metering system	 for Matrix*
Focus area	 for Wide* or  for Spot
Focus mode	<b>C</b> for Continuous Servo AF
Film advance mode	 or  for continuous shooting

\* Automatically selected.

## Procedure

1. Set focus area focus mode to **C** for Continuous Servo AF with Release Priority.
2. Set film advance mode to  or . Continuous shooting is recommended because quick response is crucial to action photography. Continuous shooting also allows you to create action-filled sequences.
3. Center the subject inside the viewfinder, lightly press the shutter release button to start Focus Tracking. Focus Tracking remains on as long as you keep the shutter release button lightly pressed and subject remains centered in the viewfinder.
4. Confirm viewfinder shows , then fully depress the shutter release button.

## CLOSE-UP PROGRAM

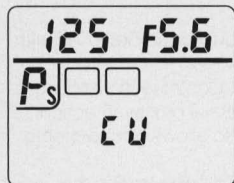

In close-up photography, various effects can be achieved with different f/stops. A very small aperture increases depth of field and enhances overall apparent sharpness. A wider aperture decreases depth of field and makes the focused subject stand out from the surrounding area (foreground and background) which will appear less sharp due to the shallow depth of field. This program selects aperture settings between f/4 and f/5.6, providing a rather shallow depth of field. The result is a sharply focused subject against a blurred background and foreground.









## Recommended lenses

AF Micro-Nikkor lenses or AF Zoom-Nikkor lenses with macro focusing function.

## Recommended camera settings

Metering system	 for Matrix*
Focus area	 for Spot
Focus mode	<b>S</b> for Single Servo AF or <b>M</b> for manual focus
Film advance mode	<b>S</b> for single-frame shooting, or  or  for continuous shooting

\* Automatically selected.

## Procedure

You can follow steps 4-6 of basic shooting procedure on pp. 21-24. However, the area you want to appear sharply focused may be slightly out of focus because depth of field is very shallow in close-up shooting. To avoid this:

1. Set focus area to  for Spot.
2. Set focus mode to **S** for Single Servo AF with Focus Priority.
3. Set film advance mode to **S** for single-frame shooting.
4. Center the desired area inside the viewfinder.
5. Lightly press the shutter release button and confirm in-focus indicator ● appears. Focus is locked as long as you keep the shutter release button lightly pressed.
6. Without removing your finger from the shutter release button, recompose the picture as desired.
7. Fully depress the shutter release button to take the picture. To avoid camera shake, use a Nikon remote cord and a tripod.

# **SPECIAL FUNCTIONS**

This chapter explains advanced photographic techniques and applications including exposure compensation methods. It also shows you how to use the self-timer, how to perform long time exposure, how to check depth of field and what to do when using non-DX-coded films.

# EXPOSURE COMPENSATION

Exposure compensation is a photographic technique that enables you to vary the final exposure settings from those measured by the camera's light meter. Nikon's 3D Matrix Metering employs methods of exposure calculation that automatically apply exposure compensation, depending upon scene brightness and contrast. As a result, your subject, whether it is centered in the viewfinder or not, is given corrected exposure in most lighting situations.

We do not recommend using any manually or automatically applied exposure compensation when using Matrix Metering. If you identify an extreme condition under which Matrix may have some difficulty, such as a severely backlit scene or one with extremes of contrast, we recommend using your camera's other built-in meters, Center-Weighted or Spot. Ultimately, only you know what the subject or a part of it requires in terms of exposure measurement. That's why the N90 camera incorporates three meters plus a variety of exposure compensation systems. The photographer's creativity is always the final deciding and controlling factor. To use the various exposure compensation functions, please refer to the following.

- Using AE-L (Auto Exposure Lock) lever (pp. 88-89)
- To obtain meter reading for a particular subject in Manual exposure mode (pp. 90-91)
- Using exposure compensation button (pp. 92-93)
- All Mode Exposure Bracketing (MF-26 users only) (see MF-26 instruction manual)

Results will vary, depending on conditions, so you will want to experiment with each method.

## About reflectance

When using the Center-Weighted or Spot Meter, always keep in mind that the exposure indicated will assume that the subject's reflectance is equivalent to 18%. If the subject varies from this reflectance, you must make an adjustment to exposure. Generally speaking, a white subject will have about a 90% reflectance, and an adjustment of 2.5 f/stops (further open) will bring the exposure back to the equivalent of an 18% reading. As another rule of thumb, when shooting a landscape, the light meter reading from green grass is roughly equivalent to 18% reflectance.

## AE-L (AUTO EXPOSURE LOCK) LEVER

In the auto exposure mode, when you want to control exposure based on the brightness of a specific area within the scene, switch the metering system to Center-Weighted or Spot and use the AE-L lever as follows:



1. Center main subject inside viewfinder and/or move in closer until reference circle for Center-Weighted metering or Spot metering is fully covered by the subject.

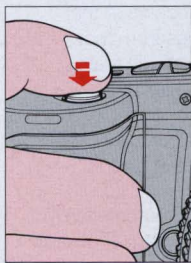

2. Lightly press shutter release button, and confirm shutter speed and aperture in viewfinder.



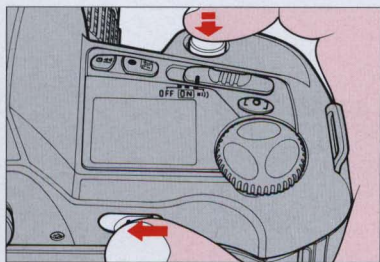

3. Keep shutter release button lightly pressed, slide AE-L lever and hold it in.

- While AE-L lever is held in, beeper does not sound for picture-blur alert even if a slow shutter speed is selected. Neither does the green  mark for dark scene/subject appear.



4. Recompose the picture and shoot.

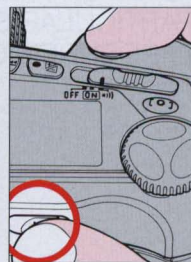

**In Single Servo AF mode**, if recomposing the picture could change subject-to-camera distance, refocus by briefly removing your finger from the shutter release button and lightly pressing it again.

**In Continuous Servo AF mode**, if recomposing the picture will not change subject-to-camera distance, push and hold the AF-L button before recomposing.

## TO OBTAIN METER READING FOR A PARTICULAR SUBJECT IN MANUAL EXPOSURE MODE

In Manual exposure mode, if you want to set exposure as desired on a particular subject, switch metering system to Center-Weighted or Spot and use the following method.

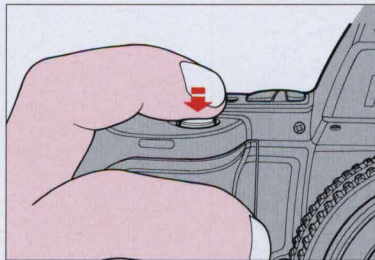

2. Lightly press shutter release button.

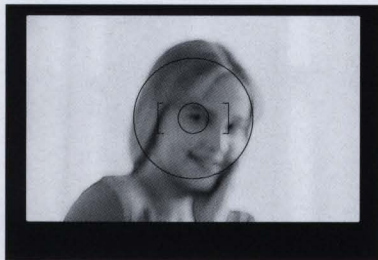

1. Center main subject inside viewfinder and/or move in closer until reference circle for Center-Weighted metering or Spot metering is fully covered by the subject.

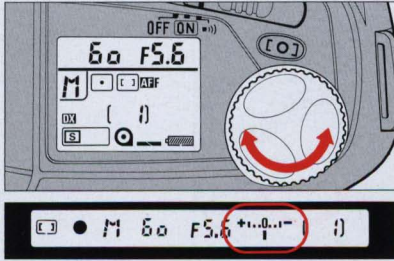

3. Adjust shutter speed and aperture until electronic analog display shows desired exposure.

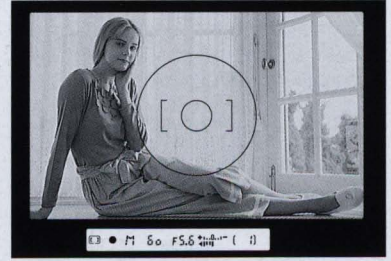
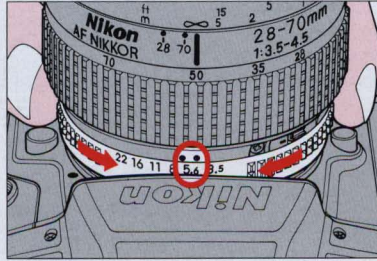

4. Recompose the picture and shoot.

**In Single Servo AF mode**, if recomposing the picture could change subject-to-camera distance, refocus by briefly removing your finger from the shutter release button and lightly pressing it again.

**In Continuous Servo AF mode**, if recomposing the picture will not change subject-to-camera distance, push and hold the AF-L button before recomposing.



## EXPOSURE COMPENSATION BUTTON

To modify exposure control (i.e., from the ISO standard) use the exposure compensation button. Compensation from -5EV to +5EV in 1/3 steps is possible. After taking your photographs, be sure to reset the control to "0" to resume normal operation.

(Center-Weighted Metering)





Without compensation

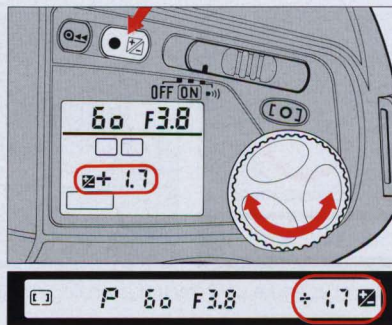

With compensation



1. While pressing  button, rotate command dial to set desired compensation value. The following display appears in LCD panel and viewfinder.

 symbol



Compensation value from -5 to +5 EV in 1/3 steps:

Confirm amount of exposure compensation.

In the example above, +1<sup>2</sup>/<sub>3</sub> compensation is set.

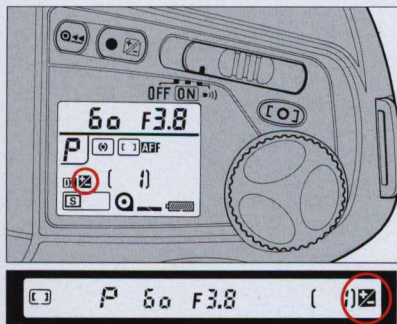



2. Once set, exposure compensation remains fixed until reset. Although the  symbol stays on to indicate that exposure compensation is on, the compensation value disappears from the readout when you remove your finger from  button. To confirm compensation value, press  button again.

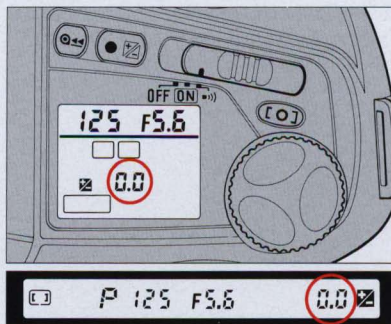

3. After shooting, be sure to reset amount of compensation to "0" to resume normal operation.

# SELF-TIMER OPERATION

You have a choice of one-shot or two-shot self-timer operation. In one-shot self-timer mode, duration is variable from 2 sec. to 30 sec.

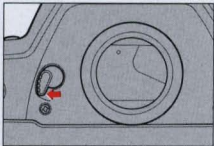



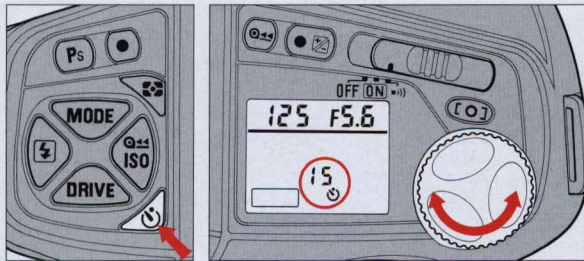

When using any auto exposure mode, use eyepiece shutter before setting self-timer to prevent stray light from entering viewfinder and affecting exposure.

- Regardless of film advance mode setting, continuous shooting is not performed (except for two-shot self-timer operation).
- Long time exposure at **bulb** setting cannot be used for self-timer operation.



## ONE-SHOT SELF-TIMER

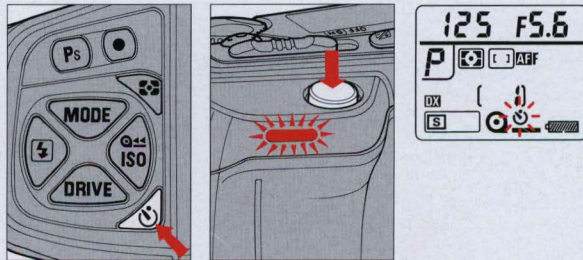

1. While pressing  button, rotate command dial until desired timer duration with  symbol appears in LCD panel. Timer duration can be varied from 2 to 30 seconds in one-second increments.
  - Next to  (for 30-sec. duration),  with  mark for two-shot self-timer appears in LCD panel.

2. Compose picture, lightly press shutter release button, and confirm focus and exposure.







3. While pressing  button, fully depress shutter release button. Self-timer LED starts blinking and  symbol in LCD panel blinks. During the final two seconds, LED blinking speeds up, accompanied by rapid electronic beeping, warning you to get ready for the shot.
  - To cancel self-timer, press  button at any time.

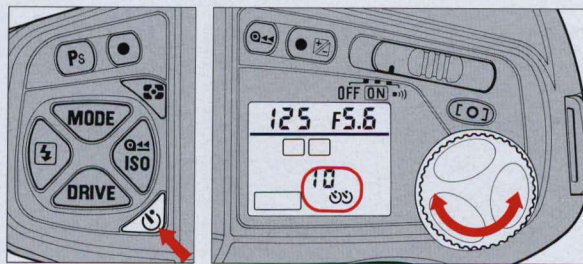



## TWO-SHOT SELF-TIMER

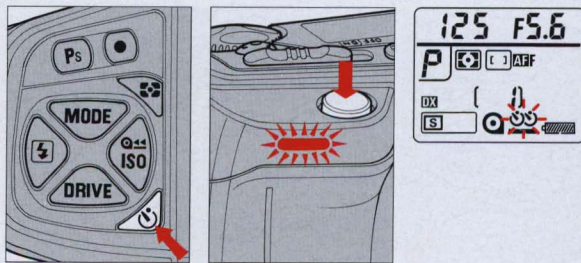

1. While pressing  button, rotate command dial counterclockwise until  with  symbol (next to ) appears in LCD panel.
2. Compose picture, lightly press shutter release button, and confirm focus and exposure.



3. While pressing  button, fully depress shutter release button. Self-timer LED and  symbol in LCD panel blinks. The shutter is released for the first shot after approx. 10 sec., and the second shot is taken 5 sec. later. Two seconds before each shot, the blinking LED speeds up, accompanied by rapid electronic beeping, warning you to get ready for the shot.
- To cancel self timer, press  button at any time.



## TO CONFIRM SHARPNESS BEFORE SHOOTING—DEPTH-OF-FIELD PREVIEW BUTTON

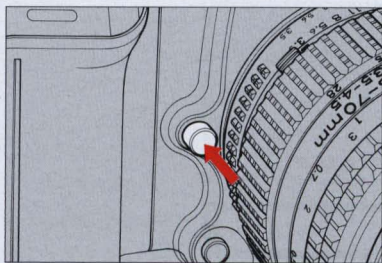

Note that when you're using a lens with an automatic diaphragm, which is what most Nikkor lenses have, the viewfinder image you see is one with the lens fully open (i.e., lens at maximum aperture). This enables you to view the depth of field before you take the picture, with the N90's Aperture-Priority auto or Manual exposure mode.

Depress the depth-of-field preview button to stop the lens down to the aperture set. The image viewed becomes progressively darker as the aperture gets smaller. Portions of the picture that appear in focus when the button is pushed down are within the depth of field.

While the depth-of-field preview button is depressed, shutter speed indication disappears and **F - -** appears in the LCD aperture readouts; also, the shutter is locked.

## LONG TIME EXPOSURE—USING *bulb* SETTING

At *bulb* setting, shutter remains open as long as shutter release button remains depressed.

To avoid camera shake, which may cause picture blur, use a tripod. Use of remote control accessories such as Nikon Remote Cord MC-20, Modulite Remote Control Set ML-3, etc. is also recommended to avoid camera shake.

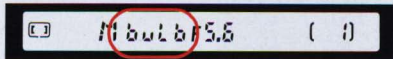
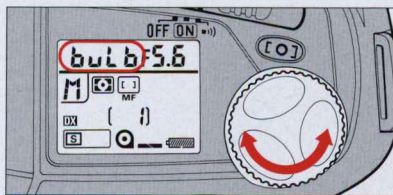

1. Press **MODE** button and rotate command dial to select **M** for Manual exposure mode.
2. Without pressing **MODE** button, rotate command dial clockwise until *bulb* appears in LCD panel and viewfinder.
3. Fully depress the shutter release button and hold it as long as desired.

### **MF-26 users**

With the MF-26's Long Time Exposure function, you can set the N90 for a time exposure as long as 99 hours, 59 minutes and 59 seconds.

Note that exposure duration depends on the life of the batteries inside the N90.

### **Data Link System users**

You can use "Time" instead of "Bulb" for long time exposure. For details, see AC-1E card instruction manual.

### **MC-20 users**

You can perform long time exposures of preset duration up to 9 hours 59 minutes 59 seconds.

Note that exposure duration depends on the life of the batteries inside the N90.

# TO USE NON-DX-CODED FILM

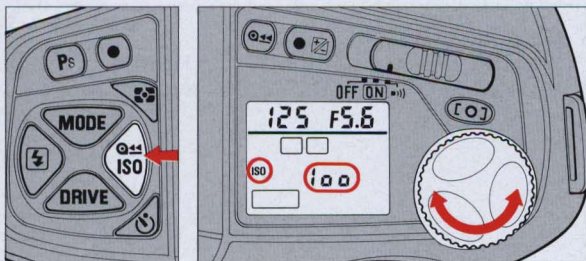

The usable range for manual film speed setting is ISO 6 to 6400.

While pressing **ISO/i00** button, rotate command dial to set film's ISO number.

Film speed setting display changes as follows:

**DX** 6 8 10 12 16 20 25 32 40 50 64 80 100 125 160  
200 250 320 400 500 640 800 1000 1250 1600 2000  
2500 3200 4000 5000 6400

To check ISO number after film loading, press **ISO/i00** button.

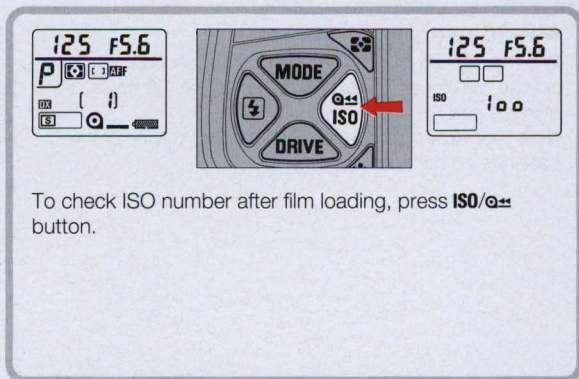

To check ISO number after film loading, press **ISO/i00** button.

- If non-DX-coded film or film with an unacceptable DX code is loaded, the **Err**, **ISO** and **DX** marks blink in LCD panel, beeper sounds, and shutter is locked. You set ISO manually.
  - You can manually set film speed for a DX-coded film, and the camera will automatically recognize the ISO number set, whether it is the higher, lower or actual ISO number.\*
- \* With the Data Link System, you can set the camera to DX-Priority.



# INTERCHANGING FOCUSING SCREENS

In addition to the advanced B-type BriteView screen supplied with the N90 camera, the E-type clear Matt/Fresnel screen with focusing brackets and grid is available as an option. Type E screen is suitable for copying and architectural photography.

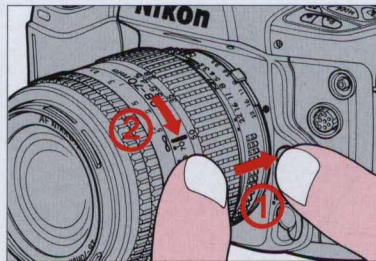

1. Remove the lens.

Be sure not to touch the focusing screen or reflex mirror with your fingers.

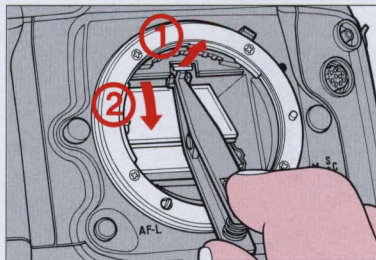

2. Slip the tip of the special tweezers (provided with each screen) under the focusing screen release latch and pull outward to spring open the holder.

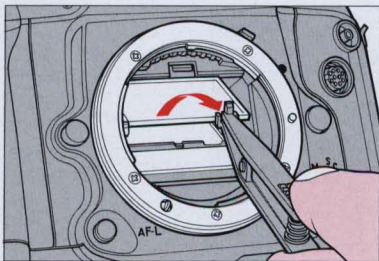

3. Remove the screen by grasping the small tab with the tweezers.

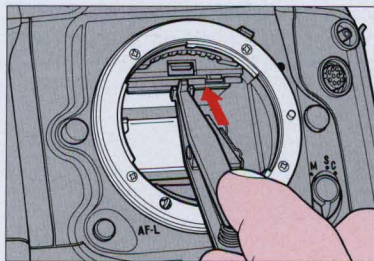

5. Using the tweezers, push the front edge of the holder upward until it clicks into place. An improperly placed focusing screen results in unreliable focus information, so always make sure the screen is in its proper place.

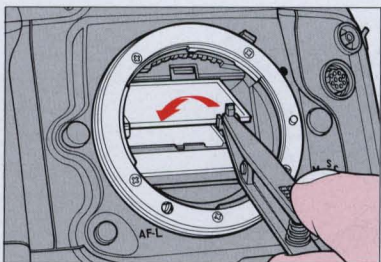

4. Carefully position the replacement screen in place, making sure the flash side is facing down.

# LENSES

Your Nikon N90 uses Nikon's respected, long-established triple-claw F-mount for rugged and reliable performance. Crafted from stainless steel, the camera's mount works perfectly with the chromed brass bayonet of each Nikkor lens. For full performance, always use Nikon lenses.

# LENS COMPATIBILITY CHART

The Nikon N90 is designed for autofocus photography with AF Nikkor lenses (except AF-Nikkor lenses for F3 AF). However, most other Nikon lenses can be used for standard photography according to the conditions listed in the following chart.

Lens/accessory	Focusing			Exposure mode				Metering system		
	Autofocus	Manual with electronic rangefinder	Manual with matte field	Programmed Auto	Shutter-Priority Auto	Aperture-Priority Auto	Manual	Matrix	Center-Weighted	Spot
AF Nikkor including D-type AF Nikkor and AF-I Nikkor lenses (except AF Nikkor for F3AF)	○	○	○	○	○	○	○	○*1	○	○
AI-P-type Nikkor lenses	○*2	○*3	○	○	○	○	○	○	○	○
AI- or AI-S-type Nikkor lenses	○*2	○*3	○	×	×	○	○	×	○	○
AI-modified Nikkor lenses	×	○*3	○	×	×	○	○	×	○	○
Medical-Nikkor 120mm f/4 IF	×	○	○	×	×	×	○*4	×	×	×
Reflex Nikkor lenses*6	×	×	○	×	×	○*7	○*7	×	○	○
PC-Nikkor lenses*6	×	×	○	×	×	○*8	○*9	×	○	○
Teleconverter TC-16A	○*10	×	×	×	×	○	○	×	○	○
AI- or AI-S-type Teleconverters (except TC-16A)	×	○*11	○	×	×	○	○	×	○	○
Bellows Focusing attachment PB-6	×	○*11	○	×	×	○*14	○*14	×	○	○
K Ring Set (K1, K3, K4 and K5)*12	×	○*11	○	×	×	○*15	○*15	×	○	○
Auto Extension Rings (11A, 12, 13 and PN-11)*13	×	○*11	○	×	×	○	○	×	○	○

- Compatible  
 × Incompatible



- \*1 3D Matrix Metering is selected with D-type AF Nikkor lenses and Advanced Matrix Metering is selected with non-D-type lenses.
- \*2 With maximum effective aperture of f/5.6 or faster when using the TC-16A Autofocus Converter. (See page 35).
- \*3 With maximum aperture of f/5.6 or faster.
- \*4 Set shutter speed to 1/125 sec. or slower.
- \*5 Because the diaphragm is coupled to the focusing ring, determining exposure is independent from camera's metering system.
- \*6 Some lenses cannot be attached to the N90 cameras. (See page 106).
- \*7 Aperture cannot be selected.
- \*8 Set preset ring, then use AE-lock lever before shifting.
- \*9 Set preset ring, then determine exposure before shifting.
- \*10 With AI- or AI-S-type Nikkor lenses having maximum aperture of f/3.5 or faster. However, some lenses cannot be used with the TC-16A (p.35).
- \*11 With maximum effective aperture of f/5.6 or faster.
- \*12 K1 Ring cannot be attached to AF Nikkor lenses. The ring may damage CPU contacts. Use PK-11A or BR-6 instead.
- \*13 PK-1, PK-2, PK-3 and PN-1 Rings cannot be attached to the N90 cameras. PK-11 Ring cannot be attached to AF Nikkor lenses. Those rings may damage CPU contacts. Use PK-11A for AF Nikkor lenses instead of PK-11.
- \*14 Shutter should be released after exposure is measured by stopping down PB-6.
- \*15 Stop-down exposure measurement will be performed.

● **The following Nikkor lenses cannot be attached to the N90 (camera body or lens may be damaged):**

- Non-AI lenses
- Fisheye 6mm f/5.6
- Fisheye OP 10mm f/5.6
- 200-600mm f/9.5 (Factory Serial No. 280001 to 301922)
- ED 180-600mm f/8 (No. 174041 to 174180)
- ED 360-1200mm f/11 (No. 174031 to 174127)
- 400mm f/5.6 and 600mm f/5.6 with Focusing Unit AU-1
- PC 28mm f/4 (No. 180900 or smaller)\*
- PC 35mm f/2.8 (No. 851001 to 906200)\*
- Reflex 1000mm f/11 (No. 142361 to 143000)\*
- Reflex 2000mm f/11 (No. 200111 to 200310)\*

\* *Can be modified, at nominal charge, for use with the N90. Contact an authorized Nikon dealer or service facility.*

● **The following teleconverters and lenses cannot be used with the N90 (correct exposure is unobtainable):**

- AF Teleconverter TC-16
- AF Nikkor 80mm f/2.8
- AF Nikkor 200mm f/3.5 IF

## About D-type AF Nikkor lenses

D-type AF Nikkor lenses enable you to maximize the N90's performance. They send information on lens focusing distance (e.g., Distance Information) to the N90's microcomputer for inclusion in the computations for 3D Matrix Metering. If Nikon Speedlight SB-25 is used, this information will also contribute to 3D Multi-Sensor Balanced Fill-Flash. D-type AF Nikkor lenses are identified by the letter "D" which follows information on maximum aperture (e.g., AF Zoom-Nikkor 28-70mm f/3.5-f/4.5 D). All AF-I Nikkor lenses are D-type.

# FLASH PHOTOGRAPHY

You can enjoy the excitement of the Nikon N90 camera's advanced flash technology by using Nikon's advanced SB-25 AF Speedlight. With the N90 System you'll discover the benefits of flash for more picture-taking situations than ever. Make fill-flash a standard part of your photography. Brighten dull scenes and erase harsh shadows for beautiful portraits. With the N90 system's automatic operation, you can make better flash pictures than ever before. There's no other system like it in the world.

# NIKON SPEEDLIGHT COMPATIBILITY

## FLASH MODES AVAILABLE WITH NIKON SPEEDLIGHTS

The table below shows the available flash modes for each Nikon Speedlight.

Speedlight	Connection	Available flash mode		
		TTL auto* <sup>1</sup>	Non-TTL Auto* <sup>4</sup>	Manual* <sup>2</sup>
SB-25, SB-24, SB-22, SB-21B* <sup>3</sup> , SB-20, SB-16B and SB-15	Direct	Yes	Yes	Yes
SB-23	Direct	Yes	No	Yes
SB-21A and SB-16A* <sup>3</sup>	Via Flash Unit Coupler AS-6	No	Yes	Yes
SB-11, SB-14 and SB-140* <sup>4</sup>	Via TTL Remote Cord SC-23	Yes	Yes	Yes
	Via Sensor Remote Cord SC-13 with sensor unit or Sync Cord with AS-15 coupled	No	Yes	Yes

\*<sup>1</sup> In TTL auto flash mode, N90 camera performs Automatic Balanced Fill-Flash or Standard TTL Flash. For details, see pp. 110-115.

\*<sup>2</sup> Set the N90's exposure mode to Aperture-Priority Auto or Manual.

\*<sup>3</sup> The difference between SB-21A and SB-21B, or between SB-16A and SB-16B, is the type of controller attached. (For details, see specific Speedlight's manual).

\*<sup>4</sup> Ultraviolet and infrared photography can be performed in manual flash mode only.

■: Automatic Balanced Fill-Flash possible.

### When using Programmed Auto exposure mode

Only TTL auto flash mode can be used.

**With SB-25:** Turning on the SB-25 automatically switches the flash mode to TTL auto.

**With other Speedlight:** If a flash mode other than TTL auto is set on the speedlight, turning on the Speedlight locks the shutter. In this case **FE** and exposure mode indicator (**P** or **P<sub>s</sub>**) blink in the LCD panel, warning that the flash mode should be set to TTL auto.



## WHAT YOU CAN DO WITH YOUR NIKON SPEEDLIGHT

Nikon Speedlights, combined with the N90 camera, offer various features and functions. The main features and functions are listed below.

Speedlight	Autofocus using AF assist illuminator <sup>*1</sup>	Slow Sync <sup>*2</sup>	Rear-Curtain Sync <sup>*3</sup>	Repeating Flash <sup>*4</sup>	Manual flash output level compensation <sup>*5</sup>	FP High-Speed Sync <sup>*6</sup>	Red-Eye Reduction <sup>*7</sup>
SB-25	Yes	Yes <sup>*8</sup>	Yes	Yes	Yes	Yes	Yes
SB-24	Yes	Yes <sup>*8</sup>	Yes	Yes	Yes	No	No
SB-23, SB-22 and SB-20	Yes	Yes <sup>*8</sup>	Yes <sup>*8</sup>	No	No	No	No
SB-16B, SB-15, SB-11, SB-14 or SB-140	No	Yes <sup>*8</sup>	Yes <sup>*8</sup>	No	No	No	No
SB-21B	No	Yes <sup>*8</sup>	Yes <sup>*8</sup>	No	No	No	No

<sup>\*1</sup> See Speedlight manual.

<sup>\*2</sup> See pp. 120-121.

<sup>\*3</sup> See pp. 122-123.

<sup>\*4</sup> See Speedlight manual.

<sup>\*5</sup> See Speedlight manual.

<sup>\*6</sup> See Speedlight manual.

<sup>\*7</sup> See pp. 124-125.

<sup>\*8</sup> Set on the camera side.

# TTL AUTO FLASH—AUTOMATIC BALANCED FILL-FLASH AND STANDARD TTL FLASH

---

## TYPE OF TTL AUTO FLASH

TTL auto is recommended for most common flash shooting situations. With the Nikon Speedlight set for TTL auto flash (see chart on page 108 for compatibility), Automatic Balanced Fill-Flash or Standard TTL Flash is performed.

Using Standard TTL Flash control, a Speedlight tends to give more illumination than needed on the main subject, resulting in an unnaturally bright subject with a dark background. With Automatic Balanced Fill-Flash, flash output is automatically compensated to balance with ambient light, resulting in a better exposure for both subject and background.

The type of TTL auto flash performed by the N90 depends on the speedlight and lens combination in use, as well as on the metering system and exposure mode you are selected.







## With SB-25

Lens	Metering system	Exposure mode	
		Programmed and Shutter-Priority Auto	Aperture-Priority Auto and Manual
AF Nikkor lens (except for AF Nikkor for F3 AF) and AI-P-Nikkor lens	Matrix, Center-Weighted and Spot	Automatic Balanced Fill-Flash with TTL Multi Sensor—3D Multi-Sensor Balanced Fill-Flash with D-type AF Nikkor lens or Multi-Sensor Balanced Fill-Flash with non-D-type AF Nikkor lens and AI-P-Nikkor lens	
Other lenses (or with accessories)	Matrix	Center-Weighted Fill-Flash*1	Center-Weighted Fill-Flash*2
	Center-Weighted	Center-Weighted Fill-Flash*3	Center-Weighted Fill-Flash
	Spot	Spot Fill-Flash*3	Spot Fill-Flash

\*1 Metering system and exposure mode automatically switch to Center-Weighted and Aperture-Priority, respectively.

\*2 Metering system automatically switches to Center-Weighted.

\*3 Exposure mode automatically switches to Aperture-Priority.

- In the SB-25's LCD readout,  and  appears for Automatic Balanced Fill-Flash with TTL Multi Sensor, or  and  appears for Center-Weighted/Spot Fill-Flash.
- Unless Programmed Auto exposure is selected, by pressing the SB-25's M button, you can cancel Automatic Balanced Fill-Flash control to perform standard TTL flash operation. For standard TTL flash, the SB-25's LCD panel shows  without . For details, see the SB-25 manual.

## When using Vari-Program

- Vari-Program can be used only with AF Nikkor including D-type AF Nikkor lenses and AI-P-Nikkor lenses. When other lenses are used, the shutter is locked.
- TTL auto flash mode and Matrix Metering are automatically selected to perform 3D Multi-Sensor Fill-Flash or Multi-Sensor Fill-Flash. In the Close-Up Program, the Speedlight does not fire the Monitor Pre-flashes for 3D Multi-Sensor Fill-Flash or Multi-Sensor Fill-Flash.



## With SB-24

Lens	Metering system	Exposure mode	
		Programmed and Shutter-Priority Auto	Aperture-Priority Auto and Manual
D-type AF Nikkor lens, non-D-type AF Nikkor lens (except for AF Nikkor for F3AF) and AI-P-Nikkor lens	Matrix, Center-Weighted and Spot	Multi-Sensor Balanced Fill-Flash	
Other lenses (or with accessories)	Matrix	Center-Weighted Fill-Flash*1	Center-Weighted Fill-Flash*2
	Center-Weighted	Center-Weighted Fill-Flash*3	Center-Weighted Fill-Flash
	Spot	Spot Fill-Flash*3	Spot Fill-Flash

\*1 Metering system and exposure mode automatically switch to Center-Weighted and Aperture-Priority, respectively.

\*2 Metering system automatically switches to Center-Weighted.

\*3 Exposure mode automatically switches to Aperture-Priority.

- In all the cases listed above, **TTL** and  for Automatic Balanced Fill-Flash appear in the SB-24's LCD panel.
- By pressing the SB-24's M button, you can cancel Automatic Balanced Fill-Flash control to perform standard TTL flash operation. For standard TTL flash, the SB-24's LCD panel shows **TTL** and blinking . For details, see the SB-24 manual.

## When using Vari-Program

- Vari-Program can be used only with AF Nikkor including D-type AF Nikkor lenses and AI-P-Nikkor lenses. With other lenses, shutter is locked.
- TTL auto flash mode and Matrix Metering are automatically selected to perform Multi-Sensor Balanced Fill-Flash.



With SB-23, SB-22 , SB-20, SB-21B\*1, SB-16B , SB-15, SB-14\*2, SB-11\*2 or SB-140\*2

Lens	Metering system	Exposure mode		
		Programmed and Shutter-Priority Auto	Aperture-Priority Auto and Manual	Manual
D-type AF Nikkor lens, non-D-type AF Nikkor lens (except for AF Nikkor for F3AF) and AI-P-Nikkor lens	Matrix, Center-Weighted and Spot	Multi-Sensor Balanced Fill-Flash		Standard TTL Flash
Other lenses (or with accessories)	Matrix	Center-Weighted Fill-Flash*3	Center-Weighted Fill-Flash*4	
	Center-Weighted	Center-Weighted Fill-Flash*5	Center-Weighted Fill-Flash	
	Spot	Spot Fill-Flash*5	Spot Fill-Flash	

*1Although possible with SB-21B, Automatic Balanced Fill-Flash is not recommended.*

*\*2 Via TTL Remote Cord SC-23*

*\*3 Metering system and exposure mode automatically switch to Center-Weighted and Aperture-Priority, respectively.*

*\*4 Metering system automatically switches to to Center-Weighted.*

*\*5 Exposure mode automatically switches to Aperture-Priority.*

### When using Vari-Program

- Vari-Program can be used only with AF Nikkor including D-type AF Nikkor lense and AI-P-Nikkor lenses.
- TTL auto flash mode and Matrix Metering are automatically selected to perform Multi-Sensor Balanced Fill-Flash.

## **AUTOMATIC BALANCED FILL-FLASH WITH TTL MULTI SENSOR—3D MULTI-SENSOR BALANCED FILL-FLASH AND MULTI- SENSOR BALANCED FILL-FLASH**

3D Multi-Sensor Balanced Fill-Flash is possible only with the combination of the N90, a D-type AF Nikkor lens and the Nikon SB-25 AF Speedlight. In this flash mode, just after you depress the shutter release button and before the shutter is activated, the SB-25 will fire a series of scarcely visible pre-flashes (Monitor Pre-flashes) that are detected by the N90's TTL Multi Sensor, then analyzed for brightness and contrast. Additionally, Distance Information from the D-type AF Nikkor lens in use, along with other exposure control information, is integrated, thus automatically compensating flash output level so that flash output and ambient light are balanced. The Monitor Pre-flashes enable 3D Multi-Sensor Balanced Fill-Flash to ensure correct exposure even in difficult situations, including scenes with a very reflective object such as a mirror or a white wall, and scenes with a very dark backgrounds.

3D Multi-Sensor Fill-Flash is performed with all the meters—Matrix, Center-Weighted and Spot.

When the N90 camera and SB-25 are used with a non-D-type AF Nikkor lens, Multi-Sensor Balanced Fill-Flash, which offers the same flash output control system but without Distance Information, is performed.

Multi-Sensor Balanced Fill-Flash can also be performed with the SB-24 and other dedicated Speedlights (shown on page 113) that do not have the Monitor Pre-flash feature.

## CENTER-WEIGHTED/SPOT FILL-FLASH

If you are using a lens without CPU (a lens other than AF Nikkor and AI-P-Nikkor), Center-Weighted Fill-Flash and Spot Fill-Flash are performed as Automatic Balanced Fill-Flash. Although the TTL Multi-Sensor is not used, flash output is properly compensated to produce a natural fill-flash effect.

## STANDARD TTL FLASH

In Standard TTL Flash, automatic flash output level compensation is not available. This means that, although the main subject is correctly exposed, the background may not be. With SB-25 or SB-24, Standard TTL allows you manual selection of flash output level compensation instead of having the computer do it automatically. So, with SB-25 or SB-24, you can intentionally cancel Automatic Balanced Fill-Flash by pressing the Speedlight's M button.

## SHUTTER SPEED/APERTURE FOR EACH EXPOSURE MODE IN TTL AUTO FLASH

When setting shutter speed and aperture, refer to the following table.

Camera's exposure mode	Shutter speed	Aperture
Programmed Auto ( <b>P</b> , <b>P<sub>s</sub></b> )	If focal length in use is 60mm or shorter: 1/250 sec. to 1/(focal length) sec.* <sup>1</sup>	Set lens to its minimum aperture. Aperture is automatically controlled between f/2.8 and lens minimum aperture* <sup>2</sup>
	If focal length in use is longer than 60mm: 1/250 sec. to 1/60 sec.* <sup>1</sup>	
Shutter-Priority Auto ( <b>S</b> )	Manually set as desired from 1/250 sec. to 30 sec.* <sup>3</sup>	
Aperture-Priority Auto ( <b>A</b> )	If focal length in use is 60mm or shorter: 1/250 sec. to 1/(focal length) sec.* <sup>1</sup>	Manually set as desired
	If focal length in use is longer than 60mm: 1/250 sec. to 1/60 sec.* <sup>1</sup>	
Manual ( <b>M</b> )	Manually set as desired from 1/250 sec. to 30 sec.* <sup>3</sup>	

\*<sup>1</sup> With Slow Sync or Rear-Curtain Sync, automatically controlled shutter speed range is extended down to 30 sec.

\*<sup>2</sup> Available maximum aperture depends on film speed in use. See chart on next page.

\*<sup>3</sup> If you set shutter speed at 1/500 sec., or faster, camera automatically shifts to 1/250 sec., as soon as Speedlight is turned on.



**Reference: Available maximum aperture for each film speed**

ISO film speed						
25	50	100	200	400	800	1000
f/2.8	f/3.3	f/4	f/4.8	f/5.6	f/6.7	f/7.1

*As film speed increases by one step, available maximum aperture is stopped down by 1/2 f/stop. If you are using a lens with a maximum aperture smaller than listed, of course, the automatically controlled aperture range is from the lens maximum aperture to its minimum aperture (i.e., its entire range).*

### Note for selecting aperture





- Make sure your subject is within flash shooting distance range.
- The larger the aperture (the smaller the f-number) you select, the farther the maximum shooting distance, whereas the smaller the aperture (the larger the f-number), the smaller the maximum shooting distance.
- If subject distance remains the same, the larger aperture you select, the less depth of field; however, Speedlight recycling time is shorter. On the other hand, the smaller the aperture, the greater the depth of field, but recycling time is longer.

### Note for selecting shutter speed

With a slower shutter speed, a smaller aperture is automatically selected, resulting in a shorter shooting distance range.

## TTL AUTO FLASH OPERATION

The difference between Automatic Balanced Fill-Flash and Standard TTL Flash is in whether the flash output level is automatically compensated or not. Operation is the same.

1. Set camera's metering system and exposure mode, referring to previous table.
2. Turn Speedlight on.  
If Wide-Area focus is set on the camera, it automatically switches over to Spot Area focus when the Speedlight connected to the camera is turned on. In this case,  blinks in the LCD panel, and  appears inside the viewfinder.
  - If Speedlight is not set at TTL auto flash mode, in Programmed Auto exposure mode, **FE** blinks to alert that Programmed Auto exposure can be used only for TTL auto flash.
3. Set Speedlight's mode selector to TTL.
  - With SB-23, setting mode selector to TTL simultaneously turns Speedlight on.
4. Look through the viewfinder, compose picture and lightly press shutter release button, while confirming exposure indication in the LCD readout. In autofocus operation, also confirm that in-focus indicator ( or ) appears.
  - For exposure alert, see next page.
  - In Programmed or Shutter-Priority Auto exposure mode, if you fail to have set the lens to minimum aperture, **FE** blinks and shutter is locked.

5. Confirm exposure and shooting distance.  
Refer to shooting distance bars of SB-25 or SB-24, or flash shooting distance range table of SB-23, SB-22 or SB-20. For details, see Speedlight's manual.
6. Confirm that ready-light is on, then fully depress shutter release button to take a picture.

### If ready-light blinks for a few seconds after shooting:

Flash has fired at maximum output, but the light might have been insufficient for correct exposure of subject. Confirm shooting distance and, if necessary, move closer to subject, or select wider aperture.

### **In Auto Multi-Program mode**

**If  $H \uparrow$  appears**, background may be overexposed. To give the background a correct exposure, reset to an exposure mode that lets you choose a faster shutter speed and/or a smaller aperture.

**If shutter speed indicator shows  $50$** , background may underexposed. To extend the automatically controlled shutter speed range, set the camera to the Slow Sync mode (p.121), or switch to another exposure mode that lets you choose a slower shutter speed and/or a wider aperture. In the Slow Sync or Rear-Curtain Sync mode,  $L \bullet$  may appear in the LCD readout to signal that the background may come out underexposed.

### **In Shutter-Priority Auto exposure mode**

**If  $H \uparrow$  appears**, background may be overexposed. To give the background a correct exposure, set a higher shutter speed. If  $H \uparrow$  remains with a shutter speed of 1/250 sec., background will be overexposed without automatic flash output level compensation.

**If electronic analog display indicates "- (minus)" value**, background may be underexposed. To give the background a correct exposure, set a slower shutter speed. If electronic analog display remains with a shutter speed of 30 sec., the background will be underexposed unless flash output level is compensated.

### **In Aperture-Priority Auto exposure mode**

**If  $H \uparrow$  appears**, background may be overexposed. To give the background a correct exposure, set a smaller aperture. If  $H \uparrow$  remains with the lens set to minimum aperture, background will be overexposed unless flash output level is compensated.

**If electronic analog display indicates "- (minus)" value**, background may be underexposed. To give the background a correct exposure, set a wider aperture or set Slow Sync to extend the automatically controlled shutter speed range. If the electronic analog display remains with the lens set to maximum aperture, the background will come out underexposed unless flash output level is compensated. In the Slow Sync or Rear-Curtain Sync mode,  $L \bullet$  may appear in the LCD readout to signal that the background may come out underexposed.

### **In Manual exposure mode**

**If electronic analog display indicates "+ (plus)" or "- (minus)" values**, background may be over- or underexposed. To give the background a correct exposure, adjust shutter speed/aperture.

If electronic analog display indicating "-" value remains with the lens set to maximum aperture, the background will be underexposed unless flash output level is compensated.

## TO MAKE NIGHT BACKGROUND MORE VISIBLE—SLOW SYNC OPERATION

When flash pictures are taken at high shutter speeds in dim light, the background may come out dark. To improve background exposure, use Slow Sync to extend the automatically controlled shutter speed range down to 30 sec. Without Slow Sync, the automatically controlled shutter speed is controlled between 1/250 sec. and 1/60 sec. or 1/(focal length) sec. When flash pictures are taken with this rather narrow shutter speed range in dim light, the subject will appear bright and well exposed, but the background may come out very dark, almost black. Setting Slow Sync extends the automatic controlled shutter speed range down to 30 sec., enabling background details to come out.





Slow Sync



Normal Sync

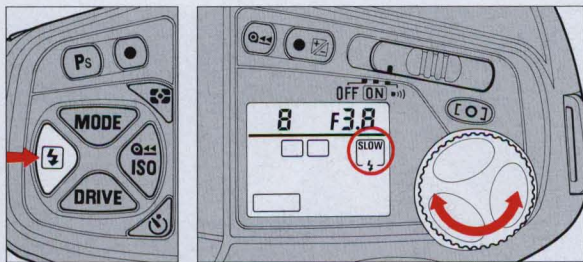



1. Set camera's exposure mode to **P** for Auto Multi-Program or **A** for Aperture-Priority Auto.
2. While pressing the camera's lightning bolt button, rotate command dial until  appears in camera's LCD panel.

Then follow steps 2-6 of TTL AUTO FLASH OPERATION, on p. 118. *Use a tripod to prevent camera shake.*

## TO CREATE NATURAL-LOOKING STREAM OF LIGHT—REAR-CURTAIN SYNC

Normally in flash synchronization, the Speedlight fires at the beginning of the exposure. When the shutter speed is low, the result is an unnatural light pattern.

When Rear-Curtain Sync is set, the Speedlight fires at the end of the exposure, turning available light into a stream of light that follows the flash-illuminated moving subject.

Since Rear-Curtain Sync is especially effective at a slow shutter speed, Slow Sync is automatically set at the same time that Rear-Curtain Sync is set in the Auto-Multi Program or Aperture-Priority Auto exposure mode. However, to set a desired shutter speed, set the N90 to Shutter-Priority Auto or Manual exposure mode.

- When the SB-25 or SB-24 is used, note that the Rear-Curtain Sync setting on the camera body is ignored. So you have to set the speedlight unit itself for Rear-Curtain Sync .
- Rear-Curtain Sync cannot be set with Vari-Program
- Rear-Curtain Sync cannot be set if Red-Eye Reduction (p. 144) has been set.



Rear-Curtain Sync with low shutter speed



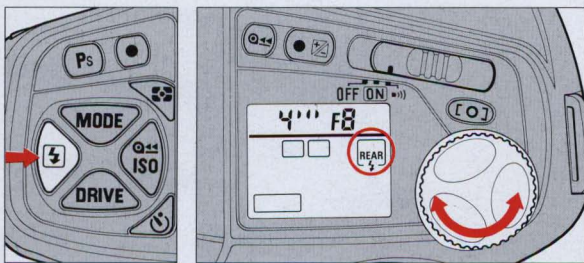

Front-Curtain Sync with low shutter speed



1. Set camera's exposure mode to **S** for Shutter-Priority Auto or **M** for Manual exposure mode.

2. Set Rear-Curtain Sync.

**For Speedlight other than SB-25 or SB-24:** While pressing the camera's  button, rotate the command dial until  appears in the camera's LCD panel.

**For SB-25 or SB-24 users:** Set the Speedlight's sync mode selector to **REAR** position. (See your Speedlight's instruction manual). Rear-Sync setting on camera is ignored.

Then follow steps 2-6 of TTL AUTO FLASH OPERATION, on p. 118. When using a low shutter speed, mount the N90 on a tripod to prevent camera shake.

You can use Rear-Curtain Sync in non-TTL auto or manual flash mode. For non-TTL auto or manual flash mode, refer to your Speedlight manual. Note that in either flash mode, you must use Aperture-Priority Auto or Manual exposure mode.

## RED-EYE REDUCTION (for use with SB-25 only)

When shooting people or animals in dim light using a flash, the subject's eye may sometimes appear red in color pictures or white in B&W pictures. The Red-Eye Reduction function reduces the possibility of "red-eye".

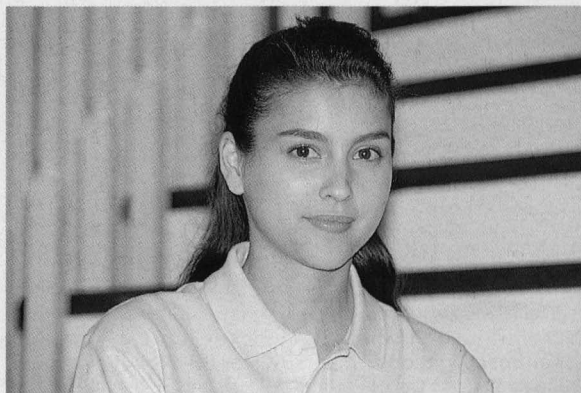

With this function, before the shutter is released and before the multi-area sensor's Monitor Pre-flashes, the flash fires three visible but relatively dim flashes, followed by the main flash which takes the picture. The three dim preflashes make the subject's eye pupils become smaller, thus reducing the appearance of red-eye.

Red-Eye Reduction can be set in any exposure mode. In the Portrait Program with Red-Eye Reduction (**P<sub>s</sub>** with **r E**), the Red-Eye Reduction function is automatically set. With other Vari-Program options, Red-Eye Reduction *cannot* be set.



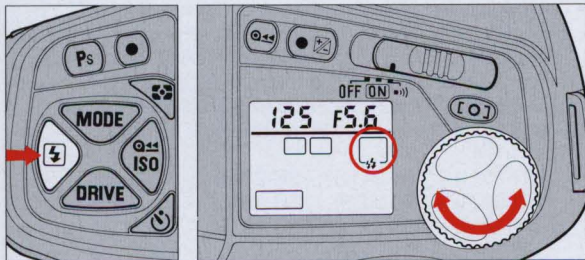



While pressing the camera's  button, rotate the command dial until  appears in camera's LCD readout. Then follow steps 2-6 of TTL Auto Flash Operation, on p118. However, with the Red-Eye Reduction function, remember that it is only at the fourth flash that the shutter is released. So *hold the camera steadily and make sure your subject keeps still during all four flashes.*

### To further reduce red-eye

- Have the subject look away from the lens, toward a bright light.
- When shooting indoors, make the room as bright as possible.

*Note that red-eye tends to be more pronounced with children and cannot be as effectively reduced.*

# NOTES ON FLASH PHOTOGRAPHY

- Use only Nikon Speedlights. Other units may damage the camera's electrical circuits due to incompatible voltage requirements\*, electric contact alignment or switch phase.

\* *Not compatible with 250V or higher.*

- When using a special Speedlight such as a studio strobe system, with a time-lag provision or one with a long flash duration (i.e., Medical-Nikkor 120mm f/4), adjust shutter speed down to 1/125 sec. or slower.

- For multiple flash photography using the N90, if the electric current in the syncro circuit exceeds a certain level, you may not be able to take a second shot after taking the first shot. Take care that the combined total of the coefficient (numbers shown in parentheses below) for all Speedlights used at any one time does not exceed 20 at 20°C/68°F or 13 at 40°C/104°F.

SB-25 (1)	SB-24 (1)	SB-23 (4)	SB-22 (6)
SB-21 (4)	SB-20 (9)	SB-19 (2)	SB-18 (16)
SB-17 (4)	SB-16 (4)	SB-15 (4)	SB-14 (1)
SB-12 (1)	SB-11 (1)		

If you are unable to take a second shot, disconnect the master Speedlight from the camera, or turn each of the Speedlights off and on at once. This resets the circuits so you can resume shooting.

This also applies when using any non-Nikon studio speedlight system.

# EV CHARTS FOR FLASH PHOTOGRAPHY

For your reference, the following charts show shutter speed/aperture combination at each EV in flash photography:

- (a) Auto Multi-Program
- (b) Shutter-Priority Auto
- (c) Aperture-Priority Auto

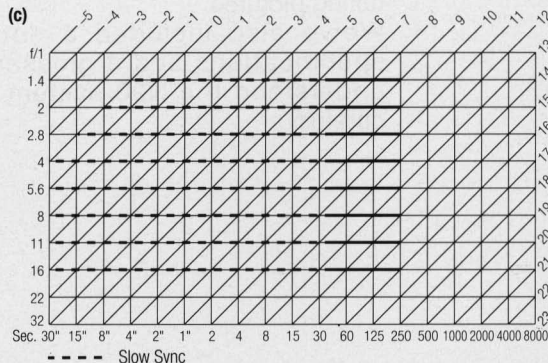
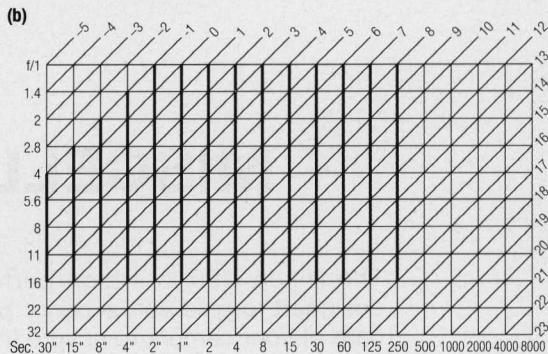
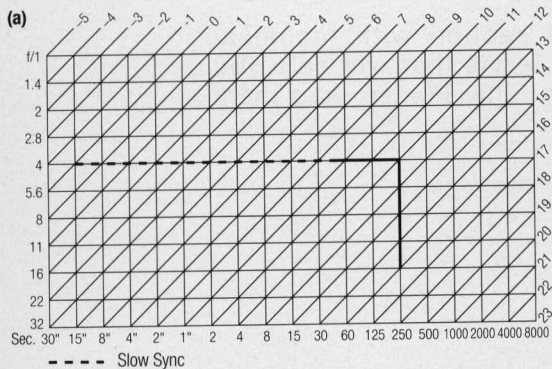

# MISCELLANEOUS

The Nikon N90 is a high-performance, precision instrument, designed to give you superior pictures. You'll want to take good care of your camera to ensure the best performance. Take time to review this section thoroughly, and you will add to the pleasure of taking pictures.

We've also included a detailed section with technical specifications and a glossary of terms that will help you understand the N90 system more fully. Please read them carefully.



## ACCESSORY COMPATIBILITY

The following accessories cannot be used with the Nikon N90 camera:

PK-1, PK-2, PK-3, PN-1, K2 BR-2 Rings

Body Cap BF-1

Eyepiece Accessories for F3HP/F3T.

- PK-1, PK-11, BR-4 and K1 Rings cannot be mounted directly on AF Nikkor lenses.
- The advanced Nikon Matrix meter evaluates scene brightness and contrast using an eight-segment sensor. Since colored filters and neutral density filters which have a high exposure factor will also significantly affect a scene's contrast rendition, they may cause the meter to incorrectly identify the scene's actual contrast/brightness condition. The blue (B12), orange (O56) and red (R60) filters are examples of such colored filters.
- Linear polarizing filters are not compatible with the viewing system used in Nikon autofocus cameras. For the best results and to maintain autofocus and exposure operation, we recommend using a circular polarizer, which is fully compatible with the Nikon system. Using a linear polarizer, however, will not damage the Nikon system, and it may be used for fully manual focusing and exposure settings made without using the built-in meter or Electronic Rangefinder.
- Special filters, such as soft focus filters, cannot be used for autofocus or for manual focus with Electronic Rangefinder.

# CAMERA CARE TIPS



1. **Do not** touch the camera's reflex mirror or focusing screen. Remove dust with a blower brush.

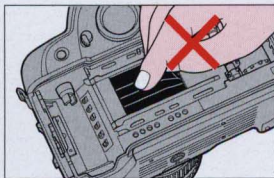

2. **Do not** touch the shutter curtains.

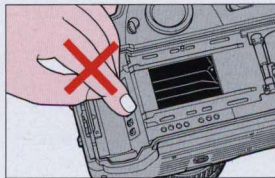

3. **Do not** touch the DX contacts. Keep them clean with a blower brush.



4. Clean the viewfinder eyepiece with a soft, clean cloth. **Do not** use alcohol.

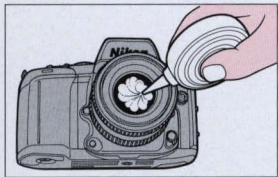

5. Clean glass surfaces, such as the lens or the eyepiece, with a blower brush; **do not** use lens tissue, silicon type eyeglass tissue, etc. To remove dirt and smudges, use soft cotton

moistened with denatured alcohol and wipe surface in a spiral motion from center to periphery. **Do not** leave traces.

## Caution!

A spray gun-type blower may damage the optical glass if used to clean the lens, especially if ED glass is used for the front lens element. To avoid damage, hold the blower upright with its nozzle more than 30cm (approx. 12 inches) from the lens surface, and keep the nozzle moving so the stream of air is not concentrated in one spot.

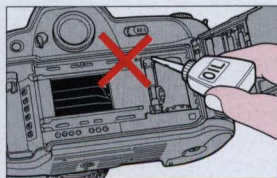

**6.** Do not lubricate the camera.

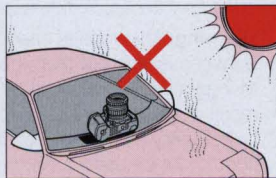

**7.** Do not leave the camera in an excessively hot place.



**8.** Keep the camera away from water or moisture. When using the camera near water, guard against splashes, especially salt water spray.



**9.** Make sure not to drop or bump the camera body/lens against a hard surface. Strong shock may cause malfunction.



**10.** If the camera malfunctions, take it immediately to an authorized Nikon dealer or service center.



**11.** Store the camera in a cool, dry place away from naphthalene or camphor (moth repellent). In a humid environment, store the camera inside a vinyl bag with a desiccant to keep out dust, moisture



and salt. Note, however, that storing leather cases in vinyl bags may cause the leather to deteriorate.

## NOTES ON BATTERIES

In certain cases, due to static electricity or poorly loaded batteries, the N90 camera's microcomputer may turn the camera off, even with fresh properly installed batteries. For the same reason, film may not advance properly. In each of these cases, to resume operation, simply turn the power off, then turn it on again, or remove batteries and install them again.

Nikon cannot be held responsible for any malfunction resulting from the use of the camera other than as specified in this manual.

**Warning:** The voltage specification for AA-type Lithium batteries is different than the voltage specification for Manganese, Alkaline and NiCd AA-type batteries. As a result of the differences, and the lack of complete testing for reliability and performance, AA-type Lithium batteries should not be used in Nikon products. Use of AA-type Lithium batteries could damage the electrical components of the Nikon products. Nikon products which use Lithium batteries, other than the AA-type, are not affected by this warning.

Compared with regular batteries, NiCd batteries provide greater efficiency at low temperatures. Before charging NiCd batteries, thoroughly read the instructions for batteries and the battery charger.





1. Keep batteries out of children's reach. If someone accidentally swallows batteries, call a doctor immediately.

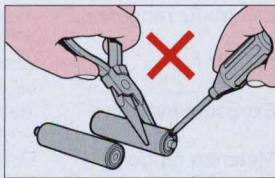

2. **Do not** disassemble, short circuit or heat batteries. **Do not** charge dry cells.

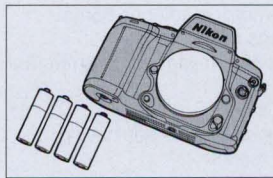

3. If you do not intend to use the camera for a long time, remove the batteries.



4. Battery power diminishes at extremely low temperatures—make sure the batteries you buy are new, and wrap the camera body in something warm.

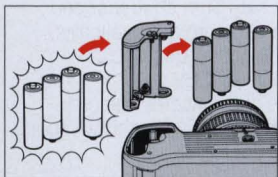

5. When replacing batteries, be sure to replace **all** batteries at the same time. Always use fresh batteries of the **same** brand.

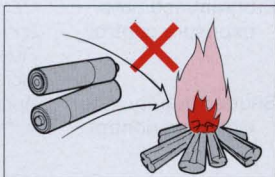

6. **Do not** throw used batteries into a fire.



7. If the battery chamber is contaminated by battery leakage, take the camera to an authorized Nikon dealer.

# SPECIFICATIONS

<b>Type of camera</b>	Integral-motor autofocus 35mm single-lens reflex	<b>Electronic rangefinder</b>	Available in Manual focus mode with AF Nikkor and other AI-type Nikkor lenses with a maximum aperture of f/5.6 or faster
<b>Picture format</b>	24mm x 36mm (standard 35mm film format)	<b>Exposure metering</b>	Three built-in exposure meters—Matrix, Center-Weighted and Spot
<b>Lens mount</b>	Nikon F mount	<b>Metering range (at ISO 100 with f/1.4 lens)</b>	EV-1 to EV 21 for Matrix and Center-Weighted metering; EV 3 to EV 21 for Spot metering
<b>Lens</b>	Nikkor and Nikon lenses having Nikon F mount* <i>* With limitation; see chart on p. 104</i>	<b>Exposure meter</b>	Activated by lightly pressing shutter release button; stays on for 8 sec., after finger leaves button
<b>Focus modes</b>	Autofocus, and Manual with Electronic Rangefinder	<b>Exposure modes</b>	Programmed auto (AutoMulti-Program and Vari-Program), Shutter-Priority auto, Aperture-Priority auto and Manual
<b>Autofocus area</b>	Wide and Spot selectable	<b>Programmed auto exposure control</b>	Camera sets both shutter speed and lens aperture automatically; Flexible Program possible in increments of 1 EV
<b>Autofocus mode</b>	Single Servo AF with Focus-Priority and Continuous Servo AF with Release-Priority	<b>Shutter-priority auto exposure control</b>	Aperture automatically selected to match manually set shutter speed
<b>Focus Tracking</b>	Automatically activated when subject moves		
<b>Autofocus detection system</b>	Nikon CAM 246 autofocus module		
<b>Autofocus detection range</b>	Approx. EV -1 to EV 19 (at ISO 100)		
<b>Autofocus lock</b>	Possible once stationary subject is in focus in Single Servo autofocus; in Continuous Servo autofocus, focus can be locked with AF-L (autofocus lock) button		

<b>Aperture-priority auto exposure control</b>	Shutter speed automatically selected to match manually set aperture
<b>Manual exposure control</b>	Both aperture and shutter speed are set manually
<b>Vari-Program</b>	Seven kinds built-in: Portrait Program, Portrait Program with red-eye reduction, Hyperfocal Program, Landscape Program, Silhouette Program, Sport Program, and Close-Up Program; each has its own program line, and specific camera settings such as metering system, focus area, etc., are automatically selected
<b>Exposure compensation</b>	With exposure compensation button; $\pm 5$ EV range, in 1/3 EV steps
<b>Auto exposure lock</b>	By sliding AE lock lever while meter is on
<b>Shutter</b>	Electromagnetically controlled vertical-travel focal-plane shutter
<b>Shutter release</b>	By motor trigger
<b>Shutter speeds</b>	Lithium niobate oscillator-controlled speeds from 1/8000 to 30 sec; electromagnetically controlled Bulb setting is provided

<b>Viewfinder</b>	Fixed eyelevel pentaprism high-eyepoint type; 0.78X magnification with 50mm lens set at infinity; approx. 92% frame coverage
<b>Eyepoint</b>	Approx. 19mm
<b>Eyepiece shutter</b>	Provided
<b>Focusing screen</b>	Nikon advanced B-type BriteView screen; interchangeable with E-type screen
<b>Viewfinder information</b>	Focus area, focus indications, exposure mode, shutter speed, aperture, electronic analog display, frame counter/exposure compensation value/Vari-Program and exposure compensation mark are all shown in LCD readout; also shows flash recommended/ready light LED
<b>LCD panel information</b>	Shutter speed, aperture, exposure mode, metering system, focus area, manual focus mark, autofocus mark with focus-/release-priority indication, flash sync, film speed, DX mark, exposure compensation mark, frame counter/Vari-Program/exposure compensation value, Custom mark, film advance mode, film loading, film rewind, self-timer, battery power

<b>ViewfinderLCD panel illumination</b>	Viewfinder and LCD panel illuminated by pressing button	<b>Self-timer</b>	Electronically controlled; timer duration selectable from 2 to 30 seconds in one-sec. increments; blinking LED indicates self-timer operation; two-shot self-timer possible; cancellable
<b>Electronic beeper</b>	With power switch at <b>■   </b> , beeper sounds as In-focus signal, operation signal or alert signal	<b>Depth-of-field preview button</b>	Provides visual verification of depth of field; can be previewed in Aperture-Priority Auto or Manual exposure mode
<b>Film speed range</b>	ISO 25 to 5000 for DX-coded film; ISO 6 to 6400 can be manually set	<b>Reflex mirror Camera back</b>	Automatic, instant-return type Hinged back; interchangeable with Nikon Multi-Control Back MF-26 or World Time Data Back MF-25
<b>Film speed setting</b>	At DX position, automatically set to ISO speed of DX-coded film used; manual setting possible	<b>Accessory shoe</b>	Standard ISO-type hot-shoe contact; ready-light contact, TTL flash contact, monitor contact; Mount receptacle for SB-25's Posi-Mount System is provided
<b>Film loading</b>	Film automatically advances to first frame when shutter release button is depressed once		
<b>Film advance</b>	In single-frame <b>S</b> shooting mode, film automatically advances one frame when shutter is released; in <b>□H</b> (continuous high) or <b>□L</b> (continuous low) shooting mode, shots are taken as long as shutter release button is depressed; in <b>□H</b> mode, shooting speed is approx. 3.6 fps, and in <b>□L</b> , approx. 2.0 fps.		
<b>Frame counter</b>	Additive type; counts back while film is being rewound		



**Flash sync control**

Slow Sync, Rear-Curtain Sync and Red-Eye Reduction functions built-in

**Flash synchronization**

In Programmed auto or Aperture-Priority Auto, shutter operates from 1/250 to 1/60 sec.\* or to 1/(focal length)\*\* in normal sync, or 1/250 to 30 sec. in slow sync; in Shutter-Priority Auto or Manual exposure mode, shutter fires at speed set, and when set from 1/250 to 1/8000 sec., shutter is automatically set to 1/250 sec.

\* With lens focal length of 60mm or longer

\*\*With lens focal length less than 60mm

**TTL Multi Sensor**

Five-segment multi-sensor used for TTL auto flash control

**Automatic Balanced  
Fill-Flash with TTL  
Multi Sensor  
Monitor Preflash**

Possible when AF Nikkor lens is used with Nikon Speedlight SB-25, SB-24, SB-23, SB-22, SB-20, etc. Nikon Speedlight SB-25 fires Monitor Pre-flash(es) for TTL multi sensor when AF Nikkor lens is used

**Flash recommended/  
ready light**



No speedlight attached: Lights up in green when flash is recommended  
Speedlight attached: Lights up in red when Nikon dedicated Speedlight is ready to fire, or blinks to warn of insufficient light for correct exposure

**Number of 36-exposure film rolls per set of fresh batteries**

	At 20°C (68°F)	At -10°C (14°F)
Alkaline-manganese (LR-6)	75	12
Manganese	20	0
NiCd (KR-AA)	55	20

\* For autofocus operation using AF Zoom-Nikkor 28-70mm f/3.5-f/4.5 D lens covering the full range from infinity ( $\infty$ ) to the closest distance and back to infinity ( $\infty$ ) before each shot, in Continuous Servo AF mode with film advance mode at CH and a shutter speed of 1/125 sec. or faster.

**Power source**  
**Battery power**  
**confirmation**

Four AA-type batteries  
 for sufficient power;   
indicates batteries are nearing  
exhaustion; blinking  indicates  
batteries are just about exhausted;  
no indication/mark appears when  
batteries are completely exhausted  
or improperly installed

**Dimensions (WxHxD)**

Approx. 154 x 106 x 69mm or 6.1 x  
4.2 x 2.7 in.

**Weight**  
**(without batteries)**

Approx. 755g or 26.6 oz.

*All specifications apply when fresh alkaline batteries are used, at normal  
temperature (20°C or 68°F).*

*Specifications and design are subject to change without notice.*

# GLOSSARY

## Balanced fill-flash operation

A technique in flash photography in which flash illumination is controlled to balance it with the ambient light on the scene. The N90 uses an Automatic Balanced Fill-Flash System with TTL Multi-Sensor for this automatic operation with a compatible Nikon TTL Speedlight.

## Continuous Servo AF

Focus detection continues for as long as the shutter release button is lightly pressed and the reflex mirror is in the viewing position. Useful when camera-to-subject distance is likely to change.

## CPU

Central Processing Unit. The electronic component which controls an electronic product's functions. AF Nikkor (including AF-D Nikkor) and AI-P-Nikkor lenses have built-in CPUs.

## Depth of field

The zone of sharpest focus in front of, behind and around the subject on which the lens is focused; can be previewed in the N90 and some other Nikon cameras

## D-type AF Nikkor lenses

AF Nikkor lenses that send to the N90's microcomputer the Distance Information used for 3D Matrix Metering or 3D Multi-Sensor Balanced Fill-Flash (with Nikon SB-25 Speedlight).

## DX code

Film information code printed on film cartridge. The N90, when set to automatic film speed setting mode, senses the film speed (ISO 25 to 5000) of DX-coded film when it is loaded.

## EV

Exposure Value: A number representing the available combinations of shutter speeds and apertures that give the same exposure effect under conditions of similar scene brightness and ISO.

At ISO 100, the combination of a one-second shutter speed and an aperture of f/1.4 is defined as EV1.

The camera may be used only within the EV range of the exposure meter. For example, with the N90, the exposure metering range is from EV -1 to EV21 for Matrix metering and Center-Weighted metering, at ISO 100 with an f/1.4 lens.

## Exposure compensation

Exposure compensation for available light is activated by changing shutter speed and/or lens aperture— by Auto exposure lock lever, by exposure compensation button or by exposure bracketing.

In flash photography with a Nikon-dedicated TTL Speedlight, exposure compensation can also be performed by varying the amount of flash output.

Camera-originated exposure compensation affects both foreground subject and background; variations in flash output amount only affect foreground.

## Exposure control

Programmed auto: Camera sets both shutter speed and aperture for correct exposure.

Shutter-Priority auto: User selects shutter speed and camera sets matching lens aperture for correct exposure.

Aperture-Priority auto: User selects aperture and camera sets matching shutter speed for correct exposure.

Manual: User selects both shutter speed and aperture, following or ignoring the meter's recommendations (by LCD readout) to achieve the desired exposure.

## Fill-flash

A method of flash photography which combines flash illumination and ambient light, but does not necessarily attempt to balance these two types of illumination.

## Focus-Priority for autofocus

Shutter cannot be released until subject is in focus. Suitable when in-focus subject is important.

With N90 camera body, Focus-Priority is given to Single Servo AF mode while Release-Priority is given to Continuous Servo AF. However, the Electronic Organizer can change priority to perform Release-Priority Single Servo AF or Focus-Priority Continuous Servo AF.

## Flash synchronization

The timing of the flash so it fires coincident with the operation of the camera's shutter. There are two types of synchronization: Normal Sync which fires the flash at the start of the exposure, and Rear Sync which fires the flash at the end of the exposure.

## f-number

The numbers on the lens aperture ring and on the N90's LCD which indicate the relative size of the lens aperture opening. The f-number series is a geometric progression based on changes in the size of the lens aperture, as it is opened and closed. As the scale rises, each number is multiplied by the factor 1.4. The standard numbers for calibration are 1.0, 1.4, 2, 2.8, 4, 5.6, 8, 11, 16, 22, 32, etc., and each change results in a doubling or halving of the amount of light transmitted by the lens.

## Hyperfocal distance

The closest point a photographer can focus on where the depth of field includes infinity. When the lens is focused for hyperfocal distance, the deepest depth of field, covering from 1/2 the hyperfocal distance to infinity, can be obtained at each f/stop. The longer the focal length, the longer the hyperfocal distance; the smaller the aperture (the larger the f/number), the shorter the hyperfocal distance.



## **ISO film speed**

The international standard for representing film sensitivity. The higher the number, the greater the sensitivity, and vice versa. A film speed of ISO 200 is twice as sensitive as ISO 100, and half that of ISO 400 film.

## **LCD**

Liquid Crystal Display. The N90 has two: the panel on top of the camera body and inside the viewfinder.

## **Manual flash**

Flash output is controlled manually in the manual flash mode, while flash output power varies automatically according to the selected aperture in the auto flash mode. Some Speedlights including the Nikon SB-25, SB-24 and SB-20 provide selectable manual outputs (full, 1/2, 1/4, 1/8, 1/16, etc.), while others provide full manual output only.

## **Matrix metering system**

An advanced camera light metering system using a multi-segment sensor and computer; available in the N90 and other Nikon SLRs such as the Nikon F-601/N6006, F-601M/N6000, F-401x/N5005, F4-series and F-801s/N8008s cameras.

## **Release-Priority for autofocus**

Shutter can be released anytime (i.e., even when subject is not in focus). Convenient so you do not miss an opportunity to take a picture and are not concerned with absolute focusing precision.

With N90 camera body, Release-Priority is given to Continuous Servo AF while Focus-Priority is given to Single Servo AF. However, the Electronic Organizer can change the priority to perform Focus-Priority Continuous Servo AF or Release-Priority Single Servo AF.

## **Single Servo AF**

Once the subject is in focus, focus is locked. Useful for recomposing the picture.

## **SLR**

Single Lens Reflex. A type of camera in which you look through the camera's lens as you view through the camera's viewfinder. Other camera functions, such as light metering and flash control, also operate through the camera's lens.

## **TTL**

Through-the-Lens. Most SLR cameras have built-in meters which measure light after it has passed through the lens, a feature that enables exposure readings to be taken from the actual image about to be recorded on film, whatever the lens angle of view and regardless of whether a filter is used or not.

---

## **TTL auto flash**

The camera's light sensor measures flash illumination, as reflected by the subject on the film and shuts off the flash when measurement indicates correct exposure. Because the sensor that controls the flash receives light through the lens, TTL auto flash can be used for bounce flash photography, fill-flash, multiple flash photography, etc. An additional advantage of TTL auto flash is that you can use a wide range of aperture settings, while ensuring correct exposure.

## **Wide-Area AF**

Cross-shaped Wide-Area Sensor (7mm horizontal, 3mm vertical) with no dead zone results in sharp focus for most subjects, including those without vertical lines.

# LCD PANEL/VIEWFINDER INDICATIONS

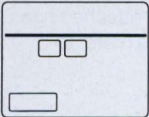
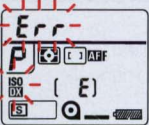
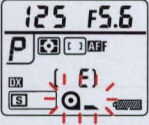
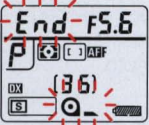
LCD panel/Viewfinder	Shutter	Cause and remedy
 <p>No indication appears when camera is turned on.</p>	Locked	Battery power is exhausted. Replace with fresh set of batteries.
 <p><b>Err</b>, ISO and <b>DX</b> marks blink*</p>	Locked	Non-DX-coded film or film with unacceptable DX code is loaded. Set manually to correct setting.
 <p><b>Q</b> blinks*</p>	Locked	Film is not correctly positioned. Reload film.
 <p><b>End</b> and <b>Q</b> blink*</p>	Locked	Film has reached end of roll. Rewind film.

\* Alert signal sounds if electronic beeper is set.

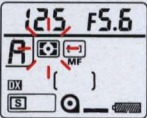
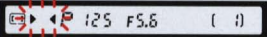
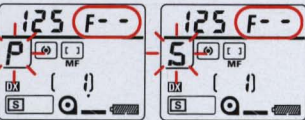
LCD panel/Viewfinder	Shutter	Cause and remedy
 <p>Matrix meter icon blinks</p>	<p>Can be released</p>	<p>Matrix meter is set even though lens attached has no CPU; camera automatically resets meter to Center-Weighted metering.</p>
 <p>Focus mode selector blinks</p>	<p>Depends on focus mode selector. Locks at <b>S</b> or can be released at <b>C</b> and <b>M</b>.</p>	<p>Autofocus is impossible with the subject. Set focus mode selector to M and focus manually using clear matte field.</p>
 <p><b>P</b> or <b>S</b> blinks and <b>F--</b> appears</p>	<p>Can be released</p>	<p>Auto-Multi Program or Shutter-Priority Auto exposure mode is set even though lens attached has no CPU. Camera automatically resets exposure mode to Aperture-Priority Auto.</p>



## LCD panel/Viewfinder

## Shutter

## Cause and remedy

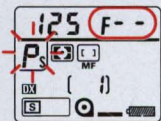

*P*s blinks and *F--* appears\*

Locked

Vari-Program is set even though lens attached has no CPU.

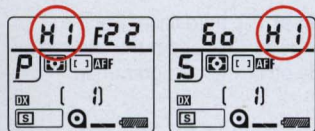

*Hi* appears in auto exposure mode\*

Can be released

Overexposure possible

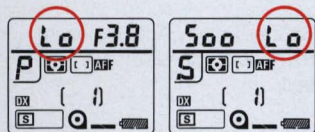

*Lo* appears in auto exposure mode\*

Can be released

Underexposure possible

\* Alert signal sounds if electronic beeper is set.

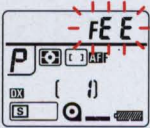
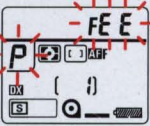
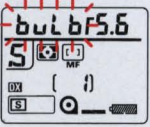
LCD panel/Viewfinder	Shutter	Cause and remedy
 <p><b>FEE</b> blinks in programmed auto or Shutter-Priority Auto exposure mode*</p>	Locked	Lens is not set to the smallest aperture setting. Set lens to the smallest aperture.
 <p><b>FEE</b> and Programmed Auto exposure indication (<b>P</b> or <b>P<sub>s</sub></b>) blink*</p>	Locked	Speedlight is not set at TTL auto flash. Set the Speedlight flash mode to TTL, or set the camera's exposure to a mode other than Programmed Auto.
 <p><b>bulb</b> blinks</p>	Locked	<b>bulb</b> is set in the Shutter-Priority Auto exposure mode. Set exposure mode to Manual or set another shutter speed.

\* Alert signal sounds if electronic beeper is set.

LCD panel/Viewfinder	Shutter	Cause and remedy
<p data-bbox="327 187 522 213">⚡ lights up in green</p> 	<p data-bbox="626 187 716 236">Can be released</p>	<p data-bbox="811 187 1033 210">Use Nikon Speedlight</p>

#### ABOUT LCD

- The N90 uses a Liquid Crystal Display (LCD) of the highest quality which, under conditions of normal use, should provide several years of reliable operation. After this period, contrast may deteriorate and display information may start to fade. You can have the LCD replaced at a nominal charge by contacting an authorized Nikon dealer or service facility.
- At high temperatures of 60°C /140°F or above, the display turns black, making it impossible to read. It returns to normal when the temperature drops to 20°C/68°F.
- At temperatures below freezing, the LCD's response time slows down; it goes back to normal when the temperature rises.

No reproduction in any form of this manual, in whole or in part (except for brief quotation in critical articles or reviews), may be made without written authorization from NIKON CORPORATION.

***Nikon***

**NIKON CORPORATION**

FUJI BLDG., 2-3, MARUNOUCHI 3-CHOME, CHIYODA-KU, TOKYO 100, JAPAN

**PHONE:** 81-3-3214-5311 **TELEX:** NIKON J22601 **FAX:** 81-3-3201-5856

Printed in Japan 9&094-Ae12 (S937)®